

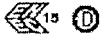

THIS INFORMATION IS CONFIDENTIAL AND PROPRIETARY TO CW INDUSTRIES INCORPORATED AND ITS AFFILIATES. IT MAY NOT BE DISCLOSED TO ANYONE, OTHER THAN CW INDUSTRIES PERSONNEL, WITHOUT WRITTEN AUTHORIZATION FROM CW INDUSTRIES INCORPORATED, SOUTHAMPTON, PENNSYLVANIA USA.

Ratings		12 (4) A 250V AC			US	Mounting Hole	Circuit	
Contact Resistance	50m ohm max.							
Insulation Resistance	DC 500V 100M ohm Min.							
Dielectric Strength	AC 1500V 1 minute							
Operation Temperature	0° C ~ 85° C							
Switch Function	6P DPDT ON - (ON)							

() = Momentary Function

MATERIAL:

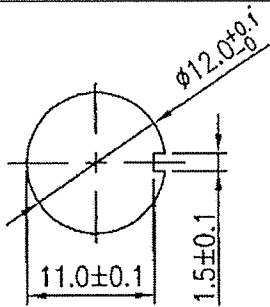
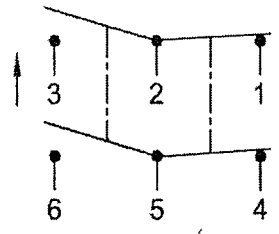
Frame: Nylon 6/6, Black
 UL Flame: 94-V0
 Lever: Nylon 66+30%GF
 UL Flame: 94-V0
 Terminal: Copper Alloy

Water proof and Dust Proof
 to fit IP-56

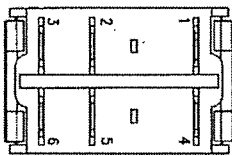
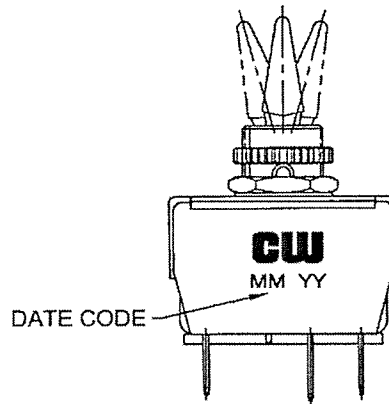
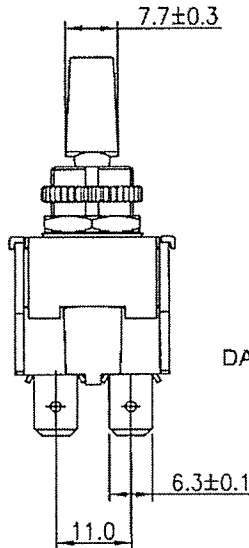
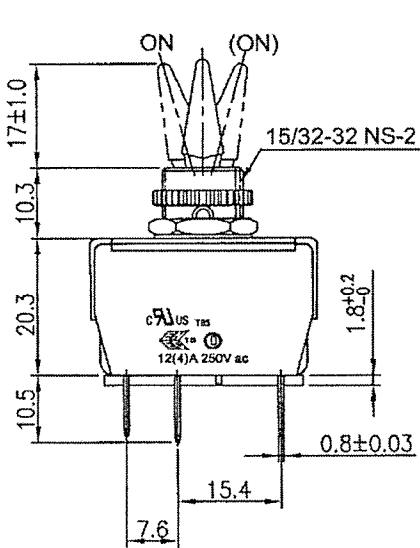
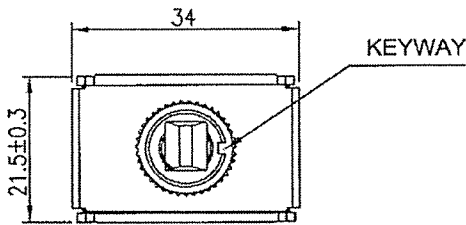

Tolerances Unless Otherwise Specified +/-0.5.

RoHS Compliant

1 Updated material notes. 3-21-13.

CW INDUSTRIES
 Southampton, Pa. 18966
 Tel 215.355.7080/www.cwind.com

Date Drawn: 8/13/12

Rev. 1

Unit: mm

Checked By: *G. Guld*

Title: **TOGGLE SWITCH**

CW P/N: **GTS448P301AHR**