



## ESSENTIAL INFORMATION

BUILD INSTRUCTIONS  
CHECKING YOUR PCB & FAULT-FINDING  
MECHANICAL DETAILS  
HOW THE KIT WORKS

CREATE SOOTHING LIGHTING EFFECTS WITH THIS

# DARK ACTIVATED COLOUR CHANGING NIGHT LIGHT KIT

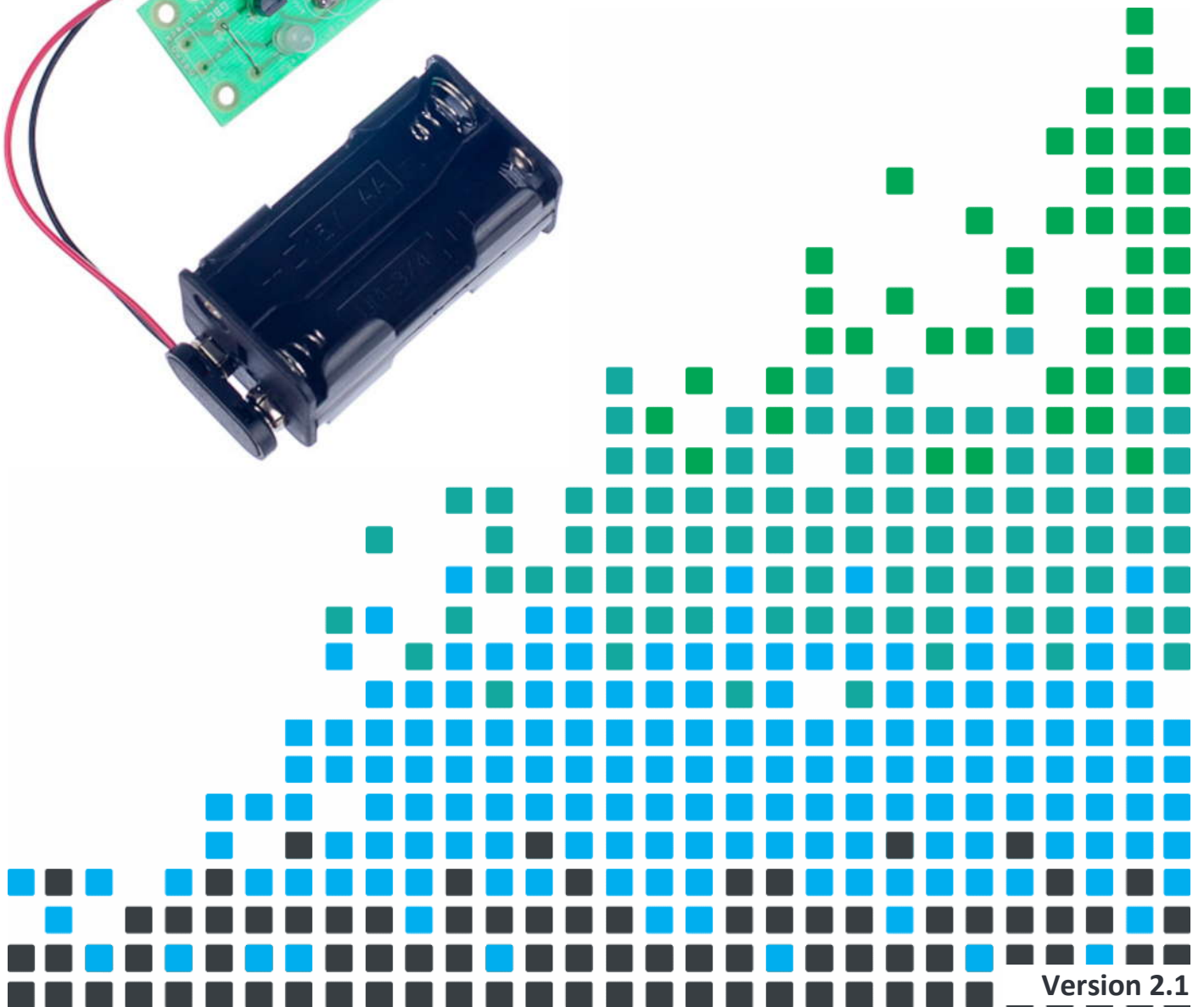
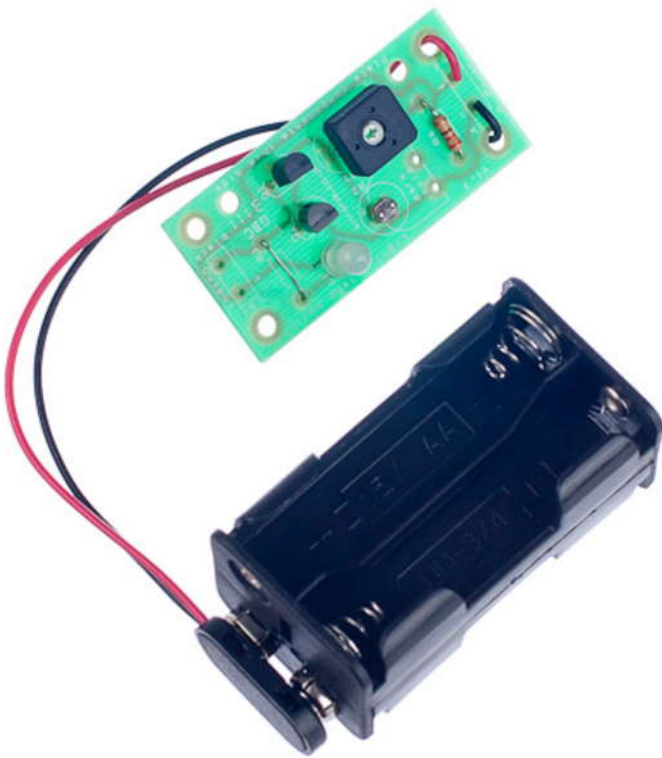

Version 2.1

## Build Instructions

Before you start, take a look at the Printed Circuit Board (PCB). The components go in the side with the writing on and the solder goes on the side with the tracks and silver pads.

### 1 PLACE THE RESISTOR

1

Start with the 220Ω resistor, which has red, red, brown coloured bands. Solder this resistor into the board where it is labelled R4.



### 2 PLACE THE TRANSISTORS

2

Place the two transistors into the board where it is labelled Q1 and Q2. It is important that they are inserted in the correct orientation. Ensure that the shape of the device matches the outline printed on the PCB. Once you are happy, solder the devices into place.



### 3 SOLDER THE VARIABLE RESISTOR

3

Solder the variable resistor into R1. It will only fit in the holes in the board when it is the correct way around.



### 4 SOLDER THE LDR

4

Solder the LDR in to the circle indicated by the text R2. This is next to the 'dark' text. It does not matter which way around it is inserted.



### 5 ADD A WIRE LINK

5

The colour changing LED used in this kit doesn't need a current limit resistor as it is a 5V LED. **Therefore we need to add a wire link.** Take a piece of wire (the lead you have just cut off the LDR is perfect) and solder it into the board where it is marked R3.

### 6 SOLDER THE LED

6

Solder the Light Emitting Diode into LED1. The LED won't work if it doesn't go in the right way around. If you look carefully one side of the LED has a flat edge, which must line up with the flat edge on the lines on the PCB.



### 7 ATTACH THE BATTERY CLIP

7

Now you must attach the battery clip. It needs to be connected to the terminals marked 'Power'. The red lead should be soldered to the '+' terminal also marked 'red' and the black lead should be soldered to the '-' terminal also marked 'black'.



## Checking Your Night Light PCB

Check the following before you connect power to the board:

### Check the bottom of the board to ensure that:

- All these leads are soldered.
- Pins next to each other are not soldered together.

### Check the top of the board to ensure that:

- The body of the two transistors matches the outline on the PCB.
- The flat edge on the LED lines matches the outline on the PCB.
- The power clip is attached where it is marked 'Power'.
- The red wire on the power clip goes to the connection marked 'red' and the black wire to the connection marked 'black'.

## Testing the PCB

You might need to adjust the variable resistor R1. It won't be far wrong if you start with the resistor pointing at the middle of the text 'components'.

- When the sensor is covered (so that it is dark) the LED should be on.
- When the sensor is light the LED should be off.

If this is not the case, recheck your board following the instructions at the top of this page.



## Fault finding flow chart

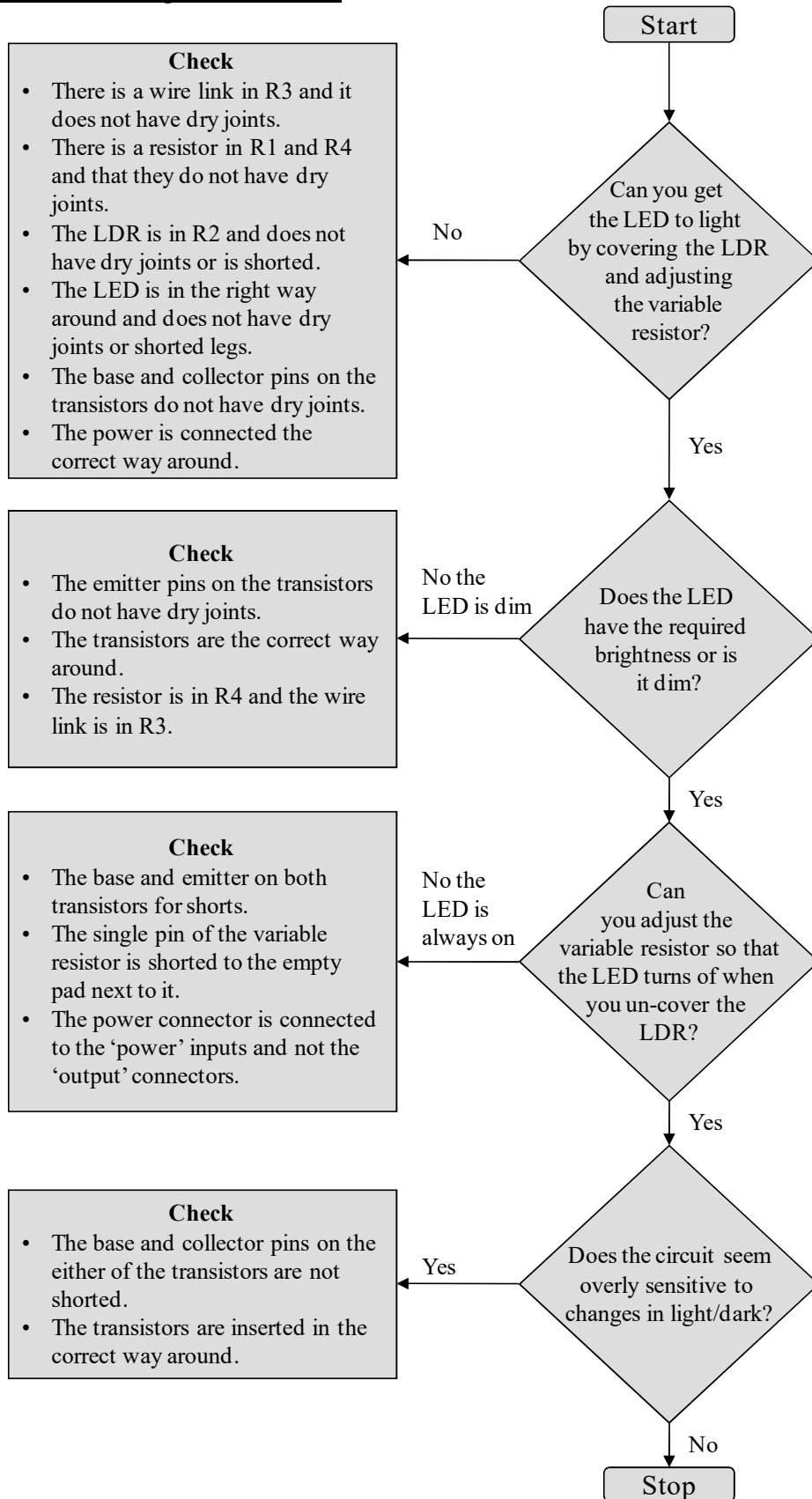

## Designing the Enclosure

When you design the enclosure, you will need to consider:

- The size of the PCB (below left).
- How big the batteries are (right).

These technical drawings of the PCB and battery holder should help you to plan this.

All dimensions in mm  
x4 holes 3.3mm diameter

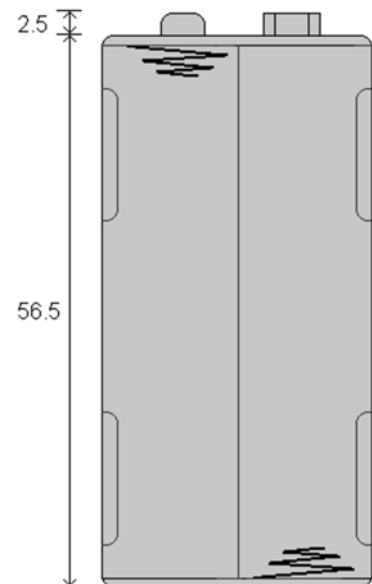
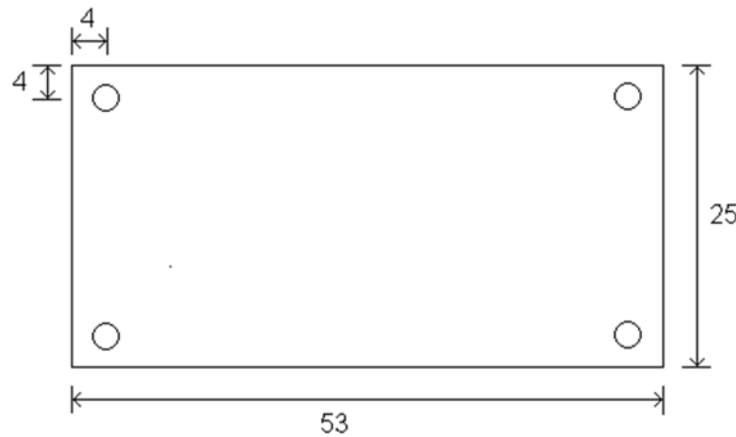
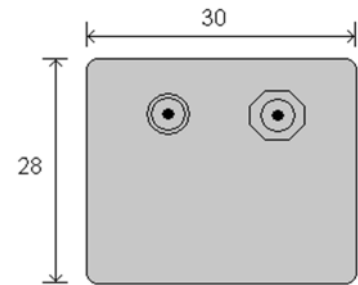

	<p><b>Mounting the PCB to the enclosure</b></p> <p>The drawing to the left shows how a hex spacer can be used with two bolts to fix the PCB to the enclosure.</p> <p><i>Your PCB has four mounting holes designed to take M3 bolts.</i></p>
--	---



## How the Dark Activated Switch Works

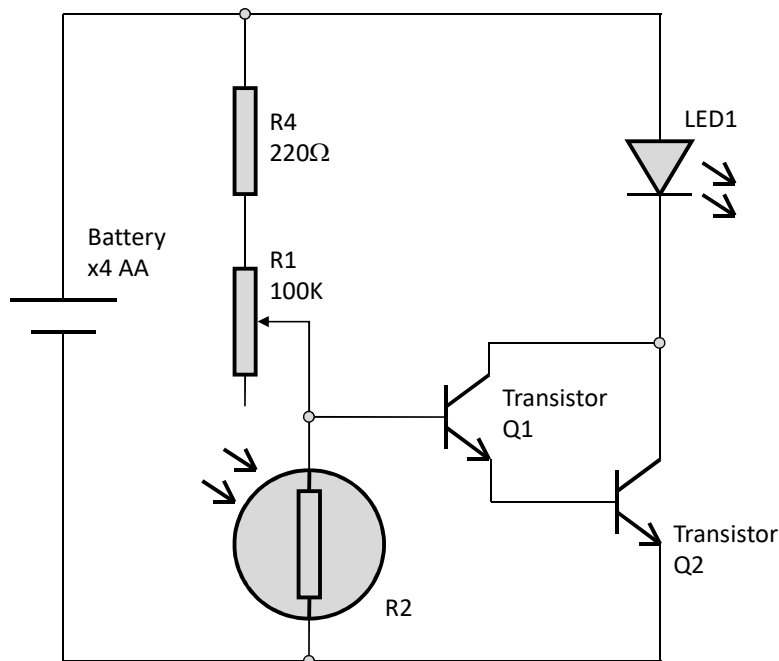

The circuit operation is very simple. When the input to the transistor Q1, which is fed from the connecting point of R1 and R2, is greater than 1.4V the output (LED), is turned on. The voltage at the join of R1 and R2 is determined by the ratio of the two resistors. This is known as potential divider.

$$\text{Voltage at joint of R1 and R2} = \text{the supply Voltage} \times \frac{R2}{R1 + R2}$$

Normally it requires 0.7V to turn on a transistor but this circuit uses two transistors in a Darlington Pair, meaning that it requires  $2 \times 0.7V = 1.4V$  to turn on both transistors.

It is also worth noting that the output, when turned on, will be around 0.9V lower than the supply voltage  $V+$ . This is because of the voltage drop across the collector and emitter pins of the Darlington Pair of transistors. Therefore if the supply voltage is 5V, then the output voltage will be around 4.1V.

R4 is present to protect the transistor should the variable resistor be set to zero.

### Adjusting the trigger level

The point at which the circuit is triggered is set by the 100KΩ variable resistor. By varying the value of this resistor, the ratio of the resistance of R1 and R2 can be varied to a point where a centre voltage (trip point) of 1.4V is achieved at the desired light level.

### LED

When the board switches on the output, the LED will turn on. With a normal LED you would need a resistor to limit the current flowing into the LED to ensure that it isn't damaged and to control the brightness. This would be resistor R3. With the colour changing LED, this is built into the LED itself. This is why when you built the kit, R3 has been replaced with a simple wire link.



## Online Information

Two sets of information can be downloaded from the product page where the kit can also be reordered from. The 'Essential Information' contains all of the information that you need to get started with the kit and the 'Teaching Resources' contains more information on soldering, components used in the kit, educational schemes of work and so on and also includes the essentials. Download from:

[www.kitronik.co.uk/2120](http://www.kitronik.co.uk/2120)



This kit is designed and manufactured in the UK by Kitronik

---

**Telephone:** +44 (0) 845 8380781

**Sales email:** [sales@kitronik.co.uk](mailto:sales@kitronik.co.uk)

**Tech support email:** [support@kitronik.co.uk](mailto:support@kitronik.co.uk)

**Web:** [www.kitronik.co.uk](http://www.kitronik.co.uk)



[www.kitronik.co.uk/twitter](http://www.kitronik.co.uk/twitter)



[www.kitronik.co.uk/facebook](http://www.kitronik.co.uk/facebook)



[www.kitronik.co.uk/youtube](http://www.kitronik.co.uk/youtube)



[www.kitronik.co.uk/google](http://www.kitronik.co.uk/google)

---

Every effort has been made to ensure that these notes are correct, however Kitronik accept no responsibility for issues arising from errors / omissions in the notes.

© Kitronik Ltd - Any unauthorised copying / duplication of this booklet or part thereof for purposes except for use with Kitronik project kits is not allowed without Kitronik's prior consent.

---

