

## ALISE-110-S

~15° spot beam

### SPECIFICATION:

Dimensions	Ø 110.0 mm
Height	65 mm
ROHS compliant	yes ⓘ

### MATERIALS:

Component	Type	Material	Colour	Finish	Coating
ALISE-110-S	Reflector	Aluminium	metal		Anodized



### ORDERING INFORMATION:

Component	Qty in box	MOQ	MPQ	Box weight (kg)
C16899_ALISE-110-S » Box size: 500 x 375 x 250 mm	300	100	25	11.1

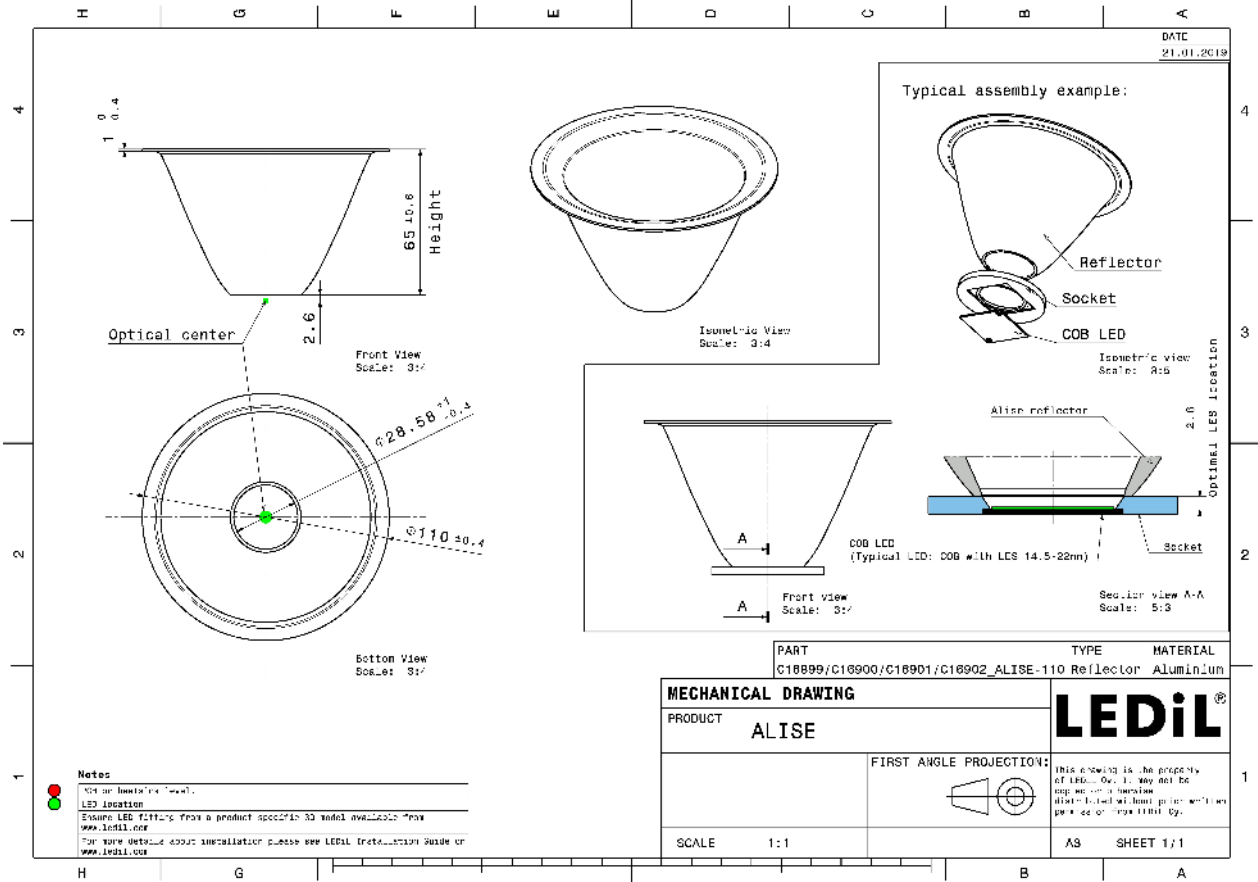

See also our general installation guide: [www.ledil.com/installation\\_guide](http://www.ledil.com/installation_guide)





## OPTICAL RESULTS (MEASURED):

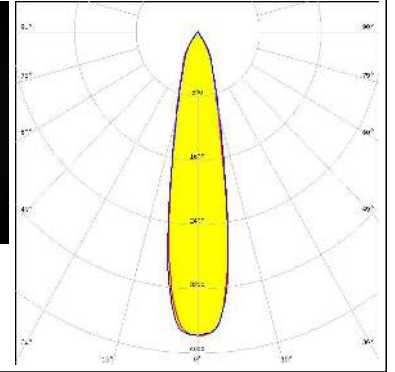

LED CMU22xx  
FWHM / FWTM 21.0° / 54.0°  
Efficiency 87 %  
Peak intensity 3.8 cd/lm  
LEDs/each optic 1  
Light colour White  
Required components:  
Bender Wirth: 431 Typ L3

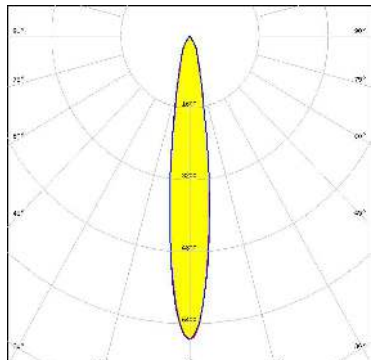
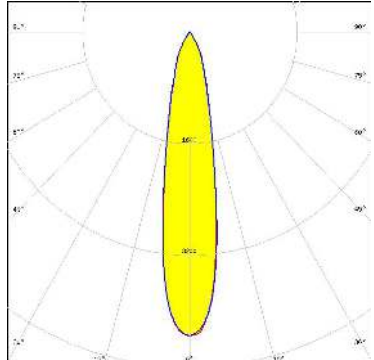

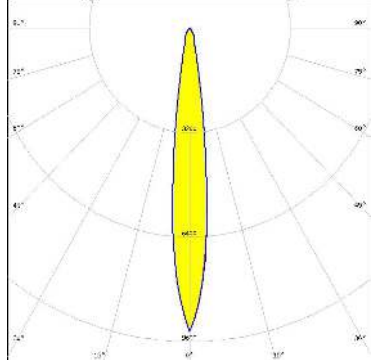

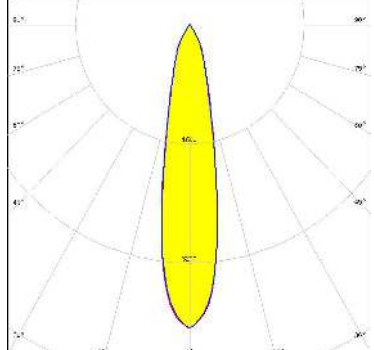

#### OPTICAL RESULTS (SIMULATED):

<p> LED Vero SE 18</p> <p>FWHM / FWTM 15.0° / 37.0°</p> <p>Efficiency 93 %</p> <p>Peak intensity 6.8 cd/lm</p> <p>LEDs/each optic 1</p> <p>Light colour White</p> <p>Required components:</p>	
<p><b>CITIZEN</b></p> <p>LED CLL04x/CLU04x</p> <p>FWHM / FWTM 20.0° / 50.0°</p> <p>Efficiency 92 %</p> <p>Peak intensity 4.4 cd/lm</p> <p>LEDs/each optic 1</p> <p>Light colour White</p> <p>Required components:</p>	
<p> LED CMA1840</p> <p>FWHM / FWTM 14.0° / 28.0°</p> <p>Efficiency 89 %</p> <p>Peak intensity 9.3 cd/lm</p> <p>LEDs/each optic 1</p> <p>Light colour White</p> <p>Required components:</p>	
<p> LED CMA3090</p> <p>FWHM / FWTM 20.0° / 52.0°</p> <p>Efficiency 89 %</p> <p>Peak intensity 4.1 cd/lm</p> <p>LEDs/each optic 1</p> <p>Light colour White</p> <p>Required components:</p>	

#### OPTICAL RESULTS (SIMULATED):

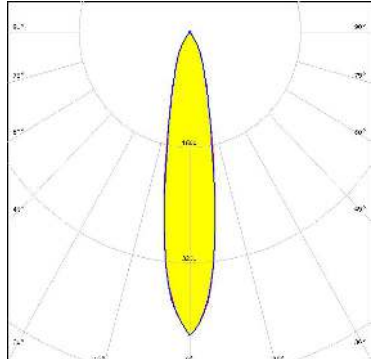
<p><b>CREE</b> → <b>LED</b></p> <p>LED: CMT28xx            FWHM / FWTM: 20.0° / 51.0°            Efficiency: 92 %            Peak intensity: 4.4 cd/lm            LEDs/each optic: 1            Light colour: White            Required components:</p>	
<p><b>CREE</b> → <b>LED</b></p> <p>LED: CXA/B 30xx            FWHM / FWTM: 17.0° / 40.0°            Efficiency: 92 %            Peak intensity: 6 cd/lm            LEDs/each optic: 1            Light colour: White            Required components:</p>	
<p><b>LUMILEDS</b></p> <p>LED: LUXEON CoB 1208            FWHM / FWTM: 14.0° / 28.0°            Efficiency: 88 %            Peak intensity: 8.8 cd/lm            LEDs/each optic: 1            Light colour: White            Required components:</p>	
<p><b>LUMILEDS</b></p> <p>LED: LUXEON CoB 1213/1216/1812            FWHM / FWTM: 21.0° / 53.0°            Efficiency: 89 %            Peak intensity: 3.9 cd/lm            LEDs/each optic: 1            Light colour: White            Required components:</p>	

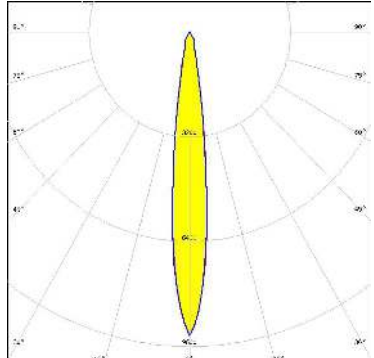
#### OPTICAL RESULTS (SIMULATED):

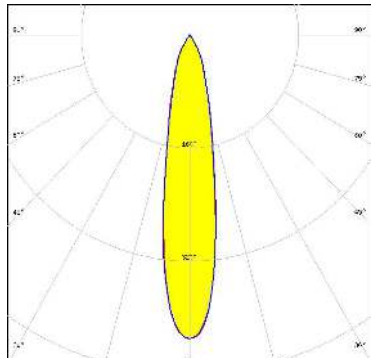
<p></p> <p>LED CxM-22 (28x28) FWHM / FWTM 20.0° / 50.0° Efficiency 89 % Peak intensity 4.2 cd/lm LEDs/each optic 1 Light colour White Required components:</p>	
<p></p> <p>LED COB J-Type FWHM / FWTM 14.0° / 28.0° Efficiency 88 % Peak intensity 9.3 cd/lm LEDs/each optic 1 Light colour White Required components:</p>	
<p></p> <p>LED LC040D / LC060D / LC080D FWHM / FWTM 20.0° / 51.0° Efficiency 91 % Peak intensity 4.3 cd/lm LEDs/each optic 1 Light colour White Required components:</p>	

### GENERAL INFORMATION:

NOTE: The typical beam angle will be changed by different color, chip size and chip position tolerance. The typical total beam angle is the full angle measured where the luminous intensity is half of the peak value.

Due to use of high power COB's with this product, special attention to proper thermal design is highly recommended. LEDiL has no liability for direct, indirect or consecutive damages arising from the LEDiL products being used outside of the recommended temperature range.

### MATERIALS:

As part of our continuous research and improvement processes, and to ensure the best possible quality and availability of our products, LEDiL reserves the right to change material grades without notice.

### PRODUCT DATA USER AGREEMENT AND DISCLAIMER:

The measured data in the provided downloadable LEDiL Product Datasheets and Mechanical 2D-Drawings is rounded and provided as reference for planning. LEDiL Oy's optical specifications have been verified by conducting performance testing of the products in accordance with the company's quality system. The reported data are averaged results of multiple measurements with typical variation. LEDiL Oy reserves the right to without prior notification make changes and improvements to its products.

LEDiL Oy assumes neither warranty, nor guarantee nor any other liability of any kind for the contents and correctness of the provided data. The provided data has been generated with highest diligence but the provided data may in reality not represent the complete possible variation range of all intrinsic parameters. Therefore, in certain cases a deviation from the provided data could occur.

LEDiL Oy reserves the right to undertake technical changes of its products without further notification which could lead to changes in the provided data. LEDiL Oy assumes no liability of any kind for the possible deviation from any provided data or any other damage resulting from the usage of the provided data.

The user agrees to this disclaimer and user agreement with the download or usage of the provided files.

#### LEDiL Oy

Joensuunkatu 13  
FI-24240 SALO  
Finland

#### LEDiL Inc.

228 West Page Street  
Suite D  
Sycamore IL 60178  
USA

#### Ledil Optics Technology (Shenzhen) Co., Ltd.

# 405 , Block B  
Casic Motor Building  
Shenzhen 518057  
P.R.CHINA

#### Local sales and technical support

[www.ledil.com/  
where\\_to\\_buy](http://www.ledil.com/where_to_buy)

#### Shipping locations

Salo, Finland  
Hong Kong, China

#### Distribution Partners

[www.ledil.com/  
where\\_to\\_buy](http://www.ledil.com/where_to_buy)