

8.26 TYP
.325

6.85 TYP
.270

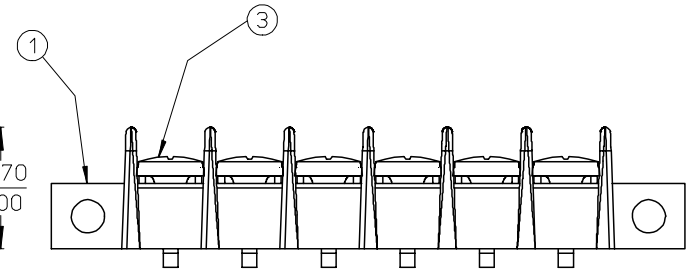
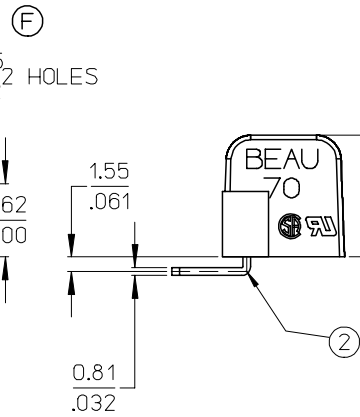
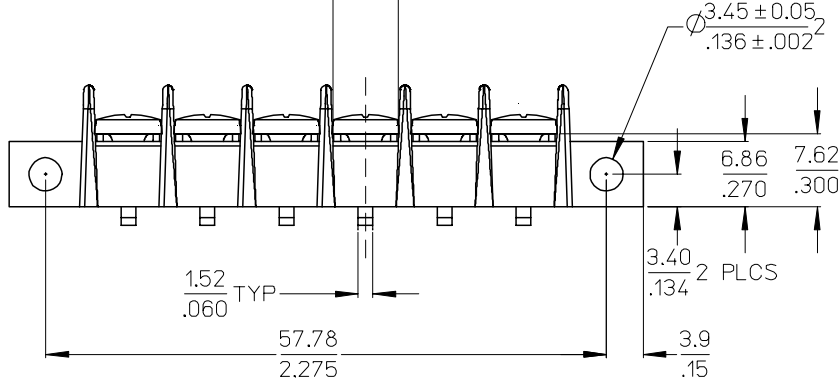

70806-49-SPCL, AS SHOWN, FOR ALL IMPRINTED
70806-49-11B SPECIALS, SEE PAGE 2 OF 2.

NOTES:

1. MATERIAL: SEE TABLE.
2. FINISHES: SEE TABLE.
3. PRODUCT SPECIFICATION: NOT REQUIRED.
4. PACKAGING: NOT REQUIRED.
5. MUST BE ROHS COMPLIANT.

ITEM	QTY.	DESCRIPTION	MATERIAL	FINISH
3	6	SCREW #6-32X.250 PAN PHLN/BRASS LUBE -	BRASS	NICKEL PLATE
2	6	TERM WIRE WRAP 6C SN/B	BRASS	TIN PLATE
1	1	SR BTS, PC RAM MOLDING, 6/C	PBT	BLACK

HOLE DIA. TOL. WAS +0051/-002
EC NO: ETC2008-0033
DRAWN: JENCINS 2007/09/16
CHKD: 2007/09/16
APPR: JMACNEIL 2007/09/17

QUALITY SYMBOLS
▽=0
▽=0

GENERAL TOLERANCES (UNLESS SPECIFIED)	
mm	INCH
4 PLACES ± ---	± ---
3 PLACES ± ---	± .005
2 PLACES ± 0.13	± .01
1 PLACE ± .3	± ---
ANGULAR ± 2 °	

DIMENSION STYLE	
MM/IN	
DRAWN BY	DATE
R. KEMP	2005/10/18
CHECKED BY	DATE
R. KEMP	2005/10/18
APPROVED BY	DATE
GHR	2005/10/18

SCALE	DESIGN UNITS	THIRD ANGLE PROJECTION
2:1	INCH	☑
TITLE		
8.26MM/.325 SR PCB BTS RAM, 6 ASSY		
MATERIAL NO.		
SEE PAGE 2		
DOCUMENT NO.		
SD-38709-009		
SHEET NO.		1 OF 2

DRAFT WHERE APPLICABLE
MUST REMAIN
WITHIN DIMENSIONS

THIS DRAWING CONTAINS INFORMATION THAT IS PROPRIETARY TO MOLEX INCORPORATED AND SHOULD NOT BE USED WITHOUT WRITTEN PERMISSION

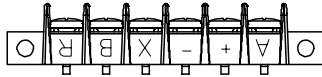

387090154, (70806-49-11B-SP223), IMPRINTED AS SHOWN

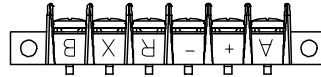

387090158, (70806-49-11B-SP265), IMPRINTED AS SHOWN

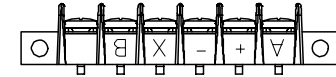

387090338, (70806-49-11B-SP451), IMPRINTED AS SHOWN

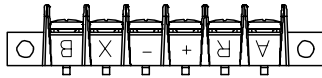

387090155, (70806-49-11B-SP224), IMPRINTED AS SHOWN

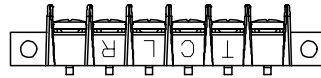

387090159, (70806-49-11B-SP266), IMPRINTED AS SHOWN

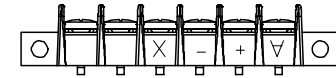

387090339, (70806-49-11B-SP452), IMPRINTED AS SHOWN

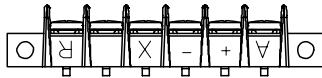

387090156, (70806-49-11B-SP225), IMPRINTED AS SHOWN

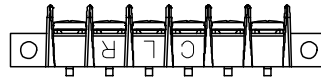

387090008, (70806-49-11B-SP291), IMPRINTED AS SHOWN

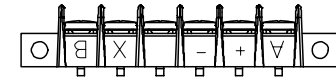

387090340, (70806-49-11B-SP453), IMPRINTED AS SHOWN

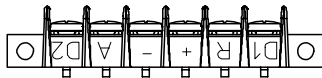

387090157, (70806-49-11B-SP226), IMPRINTED AS SHOWN

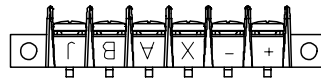

387090027, (70806-49-11B-SP300), IMPRINTED AS SHOWN

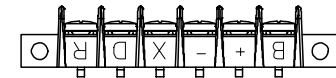

387090352, (70806-49-11B-SP504), IMPRINTED AS SHOWN

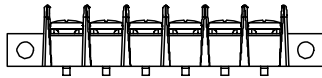

387090129, (70806-49-SPCL), NOT IMPRINTED

SEE PAGE 1 EC NO: ETC2008-0033 TDRWN: JENCINS 2007/09/04 CHKD: 2007/09/16 APPR: JMACNEIL 2007/09/17	QUALITY SYMBOLS	GENERAL TOLERANCES (UNLESS SPECIFIED)		DIMENSION STYLE		SCALE	DESIGN UNITS	THIRD ANGLE PROJECTION
	$\nabla = 0$ $\nabla = 0$	mm	INCH	MM/IN		1:1	INCH	
	DESCRIPTION	4 PLACES	± ---	± ---	DRAWN BY	DATE	TITLE	
	REV	3 PLACES	± ---	± .005	R. KEMP	2005/10/18	8.26MM/.325 SR PCB BTS RAM, 6 ASSY	
	2 PLACES	± 0.13	± .01	CHECKED BY	DATE			
	1 PLACE	± .3	± ---	R. KEMP	2005/10/18			
		ANGULAR ± 2 °		APPROVED BY	DATE			
				GHR	2005/10/18			
		DRAFT WHERE APPLICABLE MUST REMAIN WITHIN DIMENSIONS		MATERIAL NO.	DOCUMENT NO.			
				SEE ABOVE	SEE ABOVE	MOLEX INCORPORATED		
				SIZE			SHEET NO.	
				B	THIS DRAWING CONTAINS INFORMATION THAT IS PROPRIETARY TO MOLEX INCORPORATED AND SHOULD NOT BE USED WITHOUT WRITTEN PERMISSION		2 OF 2	