

August 1997

## CMOS Analog Switches

### Features

- Analog Signal Range ( $\pm 15V$  Supplies) .....  $\pm 15V$
- Low Leakage .....  $40pA$
- Low On Resistance .....  $.35\Omega$
- Break-Before-Make Delay .....  $60ns$
- Charge Injection .....  $30pC$
- TTL Compatible
- Symmetrical Switch Elements
- Low Operating Power .....  $1.0mW$

### Description

The HI-381 thru HI-390 series of switches are monolithic devices fabricated using CMOS technology and the Harris dielectric isolation process. These devices are TTL compatible and are available in four switching configurations. (See device pinout for particular switching function with a logic "1" input.)

These switches feature low leakage and supply currents, low and nearly constant ON resistance over the analog signal range, break-before-make switching and low power dissipation.

### Applications

- Sample and Hold (i.e., Low Leakage Switching)
- Op Amp Gain Switching (i.e., Low On Resistance)
- Portable, Battery Operated Circuits
- Low Level Switching Circuits
- Dual or Single Supply Systems

### Pinouts (Switch States are for a Logic "1" Input)

**DUAL SPST HI-300 AND HI-304**  
TOP VIEWS

(CERDIP, PDIP)

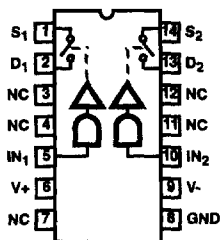

(METAL CAN)

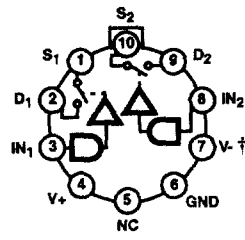

LOGIC	SWITCH
0	OFF
1	ON

† The substrate and case are internally tied to V-. (The case should not be used as the V- connection, however.)

**SPST HI-301 AND HI-305**  
TOP VIEWS

(CERDIP, PDIP)

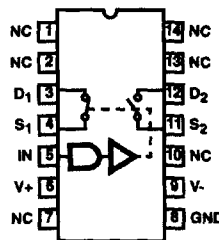

(METAL CAN)

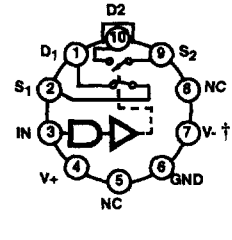

LOGIC	SW1	SW2
0	OFF	ON
1	ON	OFF

† The substrate and case are internally tied to V-. (The case should not be used as the V- connection, however.)

**DUAL DPST HI-384 (CERDIP, PDIP)**  
TOP VIEW

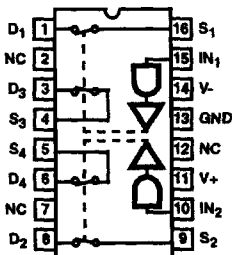

LOGIC	SW 1 - 4
0	OFF
1	ON

**DUAL SPDT HI-390 (CERDIP, PDIP, SOIC)**  
TOP VIEW

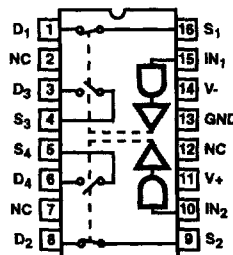

LOGIC	SW1	SW2	SW3	SW4
0	OFF	OFF	ON	ON
1	ON	ON	OFF	OFF

# HI-381 thru HI-390

## Ordering Information

PART NUMBER	TEMP. RANGE (°C)	PACKAGE	PKG. NO.
HI1-0381-2	-55 to 125	14 Ld CERDIP	F14.3
HI1-0381-5	0 to 75	14 Ld CERDIP	F14.3
HI1-0381/883	-55 to 125	14 Ld CERDIP	F14.3
HI2-0381-2	-55 to 125	10 Pin Metal Can	T10.B
HI2-0381-5	0 to 75	10 Pin Metal Can	T10.B
HI2-0381/883	-55 to 125	10 Pin Metal Can	T10.B
HI1-0384-2	-55 to 125	16 Ld CERDIP	F16.3
HI1-0384-5	0 to 75	16 Ld CERDIP	F16.3
HI1-0384/883	-55 to 125	16 Ld CERDIP	F16.3
HI1-0387-2	-55 to 125	14 Ld CERDIP	F14.3
HI1-0387-5	0 to 75	14 Ld CERDIP	F14.3
HI2-0387-2	-55 to 125	10 Pin Metal Can	T10.B
HI2-0387-5	0 to 75	10 Pin Metal Can	T10.B
HI1-0390-2	-55 to 125	16 Ld CERDIP	F16.3
HI1-0390-5	0 to 75	16 Ld CERDIP	F16.3
HI1-0390/883	-55 to 125	16 Ld CERDIP	F16.3
HI9P0390-5	0 to 75	16 Ld SOIC	M16.3
HI3-0381-5	0 to 75	14 Ld PDIP	E14.3
HI1-0387/883	-55 to 125	14 Ld CERDIP	F14.3
HI2-0387/883	-55 to 125	10 Pin Metal Can	T10.B
HI3-0387-5	0 to 75	14 Ld PDIP	E14.3
HI3-0390-5	0 to 75	16 Ld PDIP	E16.3
HI3-0384-5	0 to 75	16 Ld PDIP	E16.3

## Functional Block Diagram

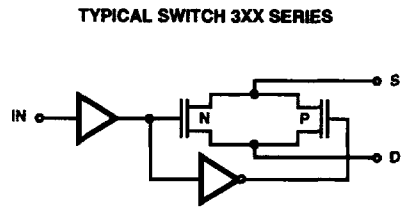

## Schematic Diagrams

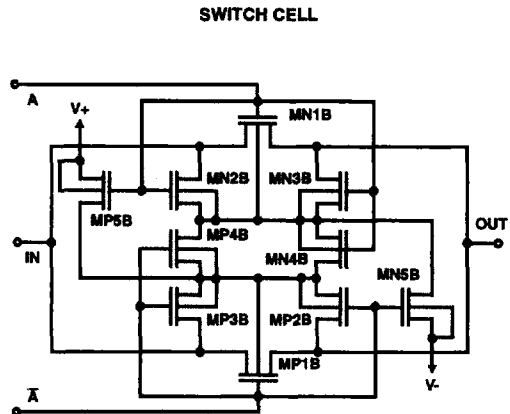

## DIGITAL INPUT BUFFER AND LEVEL SHIFTER

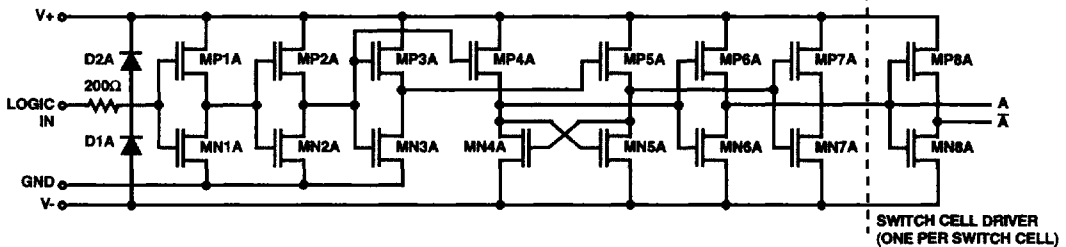

# HI-381 thru HI-390

## Absolute Maximum Ratings

Voltage Between Supplies .....	44V (±22V)
Digital Input Voltage .....	+V <sub>SUPPLY</sub> +4V -V <sub>SUPPLY</sub> -4V
Analog Input Voltage .....	+V <sub>SUPPLY</sub> +1.5V -V <sub>SUPPLY</sub> -1.5V

## Thermal Information

Thermal Resistance (Typical, Note 1)	$\theta_{JA}$ (°C/W)	$\theta_{JC}$ (°C/W)
14 Ld CERDIP Package .....	95	40
16 Ld CERDIP Package .....	90	36
PDIP Package .....	100	N/A
SOIC Package .....	100	N/A
Metal Can Package .....	160	75
Maximum Junction Temperature		
Hermetic Package .....		175°C
Plastic Package .....		150°C
Maximum Storage Temperature Range .....		-65°C to 150°C
Maximum Lead Temperature (Soldering 10s) .....		300°C
(SOIC - Lead Tips Only)		

## Operating Conditions

Temperature Ranges	
HI-3XX-2 .....	-55°C to 125°C
HI-3XX-5 .....	0°C to 75°C

**CAUTION:** Stresses above those listed in "Absolute Maximum Ratings" may cause permanent damage to the device. This is a stress only rating and operation of the device at these or any other conditions above those indicated in the operational sections of this specification is not implied.

### NOTE:

- $\theta_{JA}$  is measured with the component mounted on an evaluation PC board in free air.

## Electrical Specifications

Supplies = +15V, -15V; V<sub>IN</sub> = Logic Input. V<sub>IN</sub> for Logic "1" = 4V, for Logic "0" = 0.8V, Unless Otherwise Specified

PARAMETER	TEST CONDITIONS	TEMP (°C)	HI-3XX-2			HI-3XX-5, 9			UNITS
			MIN	TYP	MAX	MIN	TYP	MAX	
<b>SWITCHING CHARACTERISTICS</b>									
Break-Before-Make Delay, t <sub>OPEN</sub> (HI-387/HI-390 Only)		25	-	60	-	-	60	-	ns
Switch On Time, t <sub>ON</sub>		25	-	210	300	-	210	300	ns
Switch Off Time, t <sub>OFF</sub>		25	-	160	250	-	160	250	ns
"Off Isolation"	(Note 5)	25	-	60	-	-	60	-	dB
Charge Injection	(Note 6)	25	-	3	-	-	3	-	mV
Input Switch Capacitance, C <sub>S(OFF)</sub>		25	-	16	-	-	16	-	pF
Output Switch Capacitance, C <sub>D(OFF)</sub>		25	-	14	-	-	14	-	pF
Output Switch Capacitance, C <sub>D(ON)</sub>		25	-	35	-	-	35	-	pF
Digital Input Capacitance (High), C <sub>IH</sub>		25	-	5	-	-	5	-	pF
Digital Input Capacitance (Low), C <sub>IL</sub>		25	-	5	-	-	5	-	pF
<b>DIGITAL INPUT CHARACTERISTICS</b>									
Input Low Level, V <sub>INL</sub>		Full	-	-	0.8	-	-	0.8	V
Input High Level, V <sub>INH</sub>		Full	4	-	-	4	-	-	V
Input Leakage Current (Low), I <sub>INL</sub>	(Note 4)	Full	-	-	1	-	-	1	µA
Input Leakage Current (High), I <sub>INH</sub>	(Note 4)	Full	-	-	1	-	-	1	µA
<b>ANALOG SWITCH CHARACTERISTICS</b>									
Analog Signal Range		Full	-15	-	+15	-15	-	+15	V
On Resistance, r <sub>ON</sub>	(Note 1)	25	-	35	50	-	35	50	Ω
		Full	-	40	75	-	45	75	Ω
Off Input Leakage Current, I <sub>S(OFF)</sub>	(Note 2)	25	-	0.04	1	-	0.04	5	nA
		Full	-	1	100	-	0.2	100	nA
Off Output Leakage Current, I <sub>D(OFF)</sub>	(Note 2)	25	-	0.04	1	-	0.04	5	nA
		Full	-	1	100	-	0.2	100	nA
On Input Leakage Current, I <sub>S(ON)</sub>	(Note 3)	25	-	0.03	1	-	0.03	5	nA
		Full	-	0.5	100	-	0.2	100	nA

# HI-381 thru HI-390

**Electrical Specifications** Supplies = +15V, -15V;  $V_{IN}$  = Logic Input.  $V_{IN}$  for Logic "1" = 4V, for Logic "0" = 0.8V, Unless Otherwise Specified (Continued)

PARAMETER	TEST CONDITIONS	TEMP (°C)	HI-3XX-2			HI-3XX-5, 9			UNITS
			MIN	TYP	MAX	MIN	TYP	MAX	
<b>POWER SUPPLY CHARACTERISTICS</b>									
Current, I+	(Note 7)	25	-	0.09	0.5	-	0.09	0.5	mA
		Full	-	-	1	-	-	1	mA
Current, I-	(Note 7)	25	-	0.01	10	-	0.01	100	μA
		Full	-	-	100	-	-	-	μA
Current, I+	(Note 8)	25	-	0.01	10	-	0.01	100	μA
		Full	-	-	100	-	-	-	μA
Current, I-	(Note 8)	25	-	0.01	10	-	0.01	100	μA
		Full	-	-	100	-	-	-	μA

**NOTES:**

- $V_S = \pm 10V$ ,  $I_{OUT} = \pm 10mA$ . On resistance derived from the voltage measured across the switch under the above conditions.
- $V_S = \pm 14V$ ,  $V_D = \pm 14V$ .
- $V_S = V_D = \pm 14V$ .
- The digital inputs are diode protected MOS gates and typical leakages of 1nA or less can be expected.
- $V_S = 1V_{RMS}$ ,  $f = 500kHz$ ,  $C_L = 15pF$ ,  $R_L = 1K$ ,  $C_L = C_{FIXTURE} + C_{PROBE}$  "off isolation" = 20 Log  $V_S/V_D$ .
- $V_S = 0V$ ,  $C_L = 10,000pF$ , Logic Drive = 5V pulse. Switches are symmetrical; S and D may be interchanged.
- $V_{IN} = 4V$  (one input) (all other inputs = 0V).
- $V_{IN} = 0.8V$  (all inputs).

## Typical Performance Curves

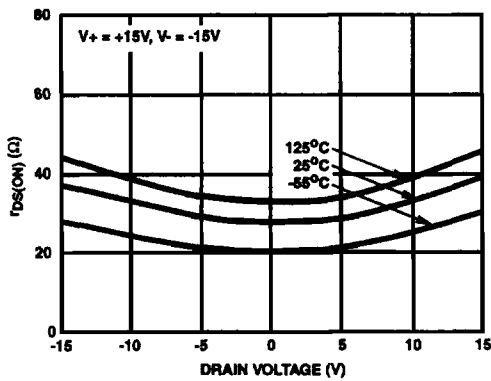

FIGURE 1.  $r_{DS(ON)}$  vs  $V_D$  AND TEMPERATURE

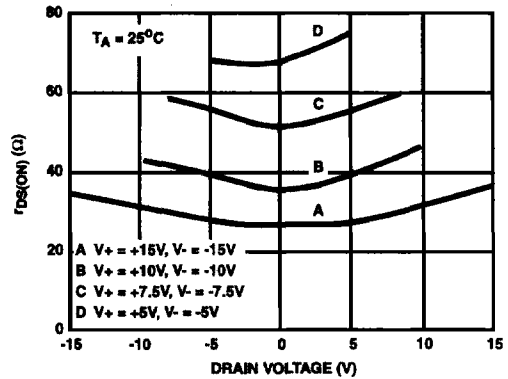

FIGURE 2.  $r_{DS(ON)}$  vs  $V_D$  AND POWER SUPPLY VOLTAGE

Typical Performance Curves (Continued)

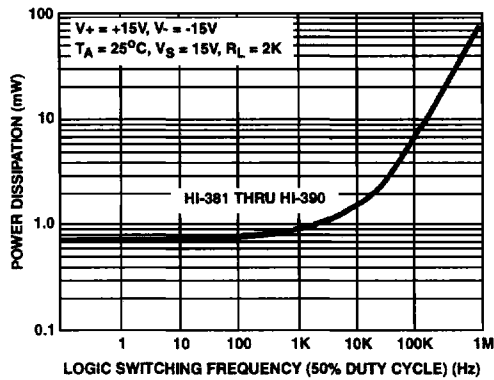

FIGURE 3. DEVICE POWER DISSIPATION vs SWITCHING FREQUENCY (SINGLE LOGIC INPUT)

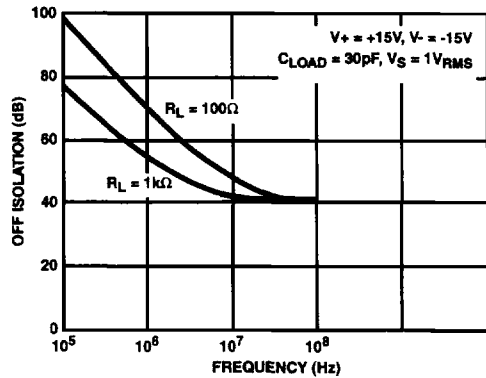

FIGURE 4. OFF ISOLATION vs FREQUENCY

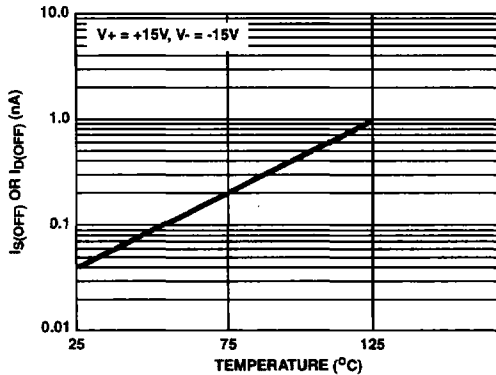

FIGURE 5.  $I_{S(OFF)}$  OR  $I_{D(OFF)}$  vs TEMPERATURE (NOTE)

NOTE: The net leakage into the source or drain is the N-Channel leakage minus the P-Channel leakage. This difference can be positive, negative or zero depending on the analog voltage and temperature, and will vary greatly from unit to unit.

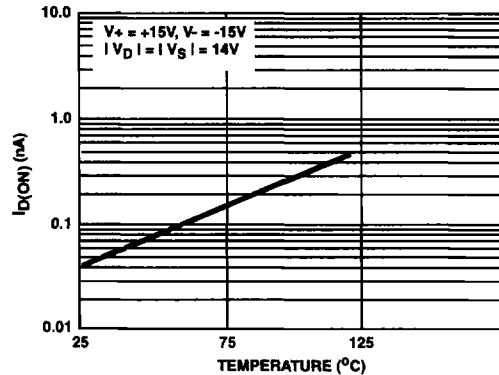

FIGURE 6.  $I_{D(ON)}$  vs TEMPERATURE (NOTE)

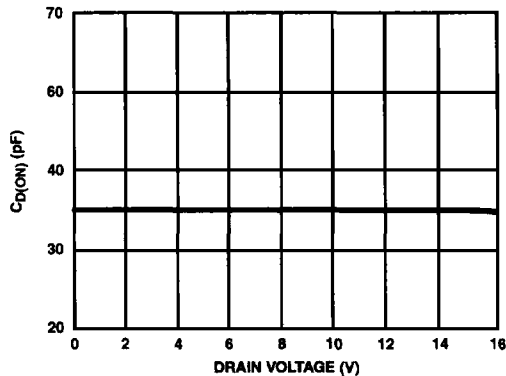

FIGURE 7. OUTPUT ON CAPACITANCE vs DRAIN VOLTAGE

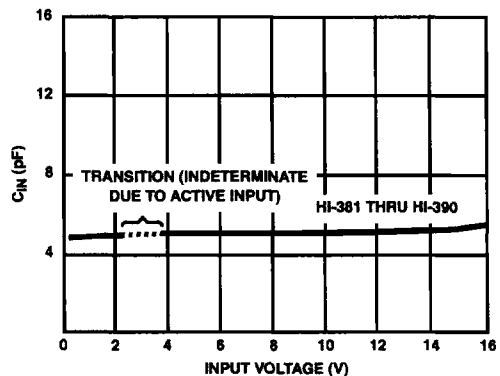

FIGURE 8. DIGITAL INPUT CAPACITANCE vs INPUT VOLTAGE

Typical Performance Curves (Continued)

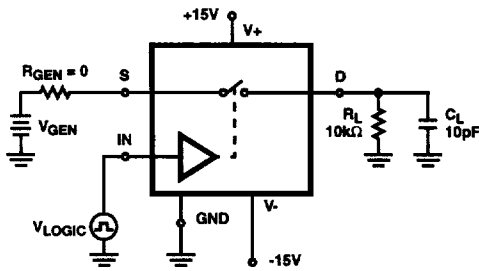

FIGURE 9A. TEST CIRCUIT

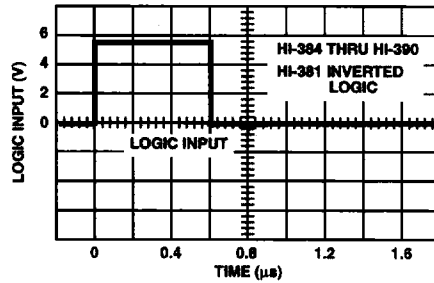

FIGURE 9B.  $V_{IN}$  LOGIC vs TIME

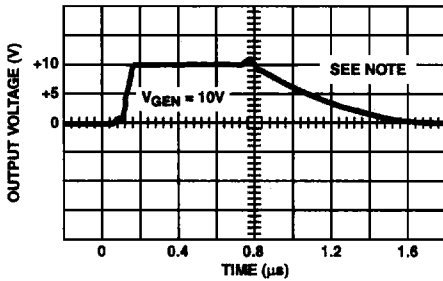

FIGURE 9C.  $V_{OUT}$  vs TIME

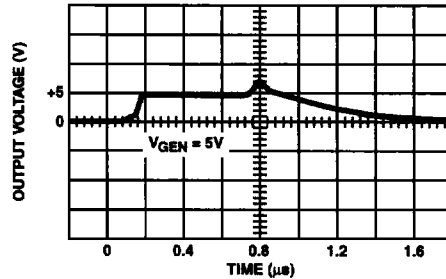

FIGURE 9D.  $V_{OUT}$  vs TIME

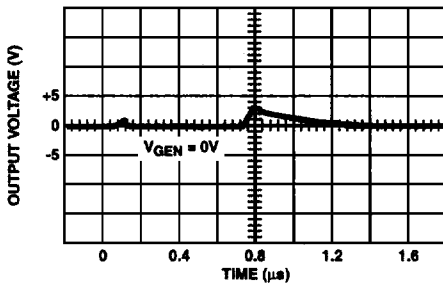

FIGURE 9E.  $V_{OUT}$  vs TIME

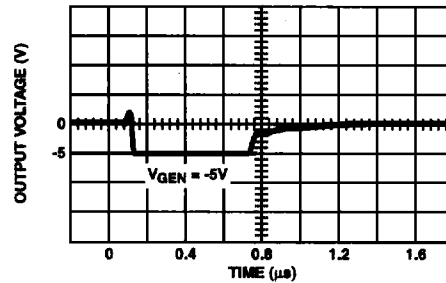

FIGURE 9F.  $V_{OUT}$  vs TIME

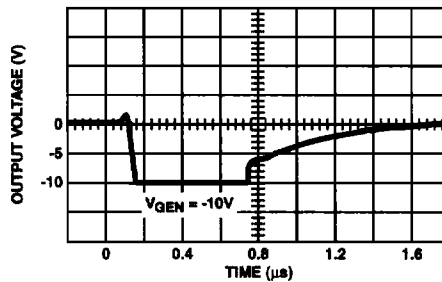

FIGURE 9G.  $V_{OUT}$  vs TIME

NOTE: If  $R_{GEN}$ ,  $R_L$  or  $C_L$  is increased, there will be proportional increases in rise and/or fall RC times.

FIGURE 9. TYPICAL DELAY, RISE, FALL, SETTLING TIMES AND SWITCHING TRANSIENTS

Typical Performance Curves (Continued)

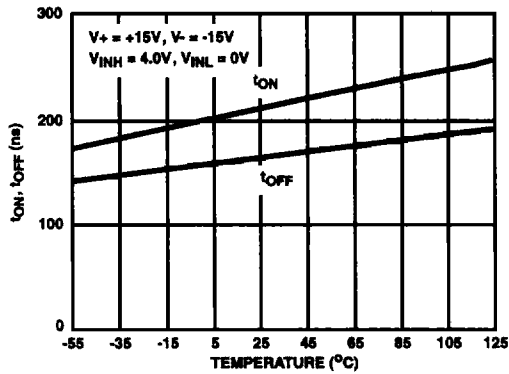

FIGURE 10. SWITCHING TIME vs TEMPERATURE, HI-381 THRU HI-390

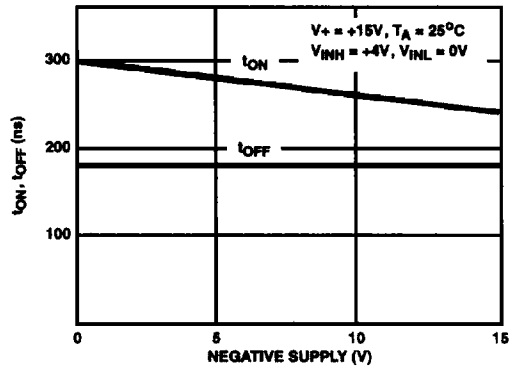

FIGURE 11. SWITCHING TIME vs NEGATIVE SUPPLY VOLTAGE, HI-381 THRU HI-390

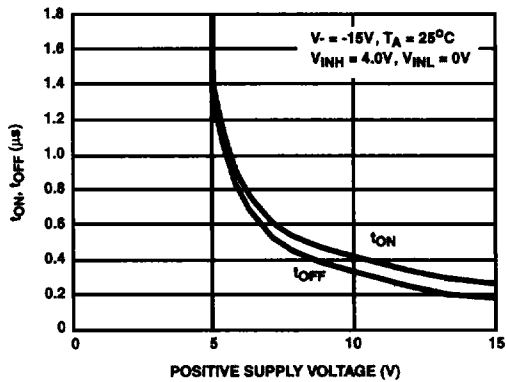

FIGURE 12. SWITCHING TIME vs POSITIVE SUPPLY VOLTAGE, HI-381 THRU HI-390

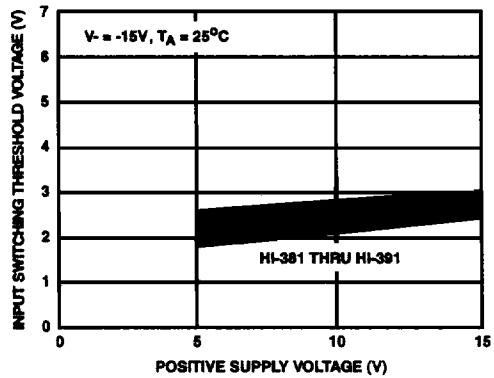

FIGURE 13. INPUT SWITCHING THRESHOLD vs POSITIVE SUPPLY VOLTAGE, HI-381 THRU HI-390