

PAN1781

Bluetooth® Low Energy Module

Product Specification

Rev. 1.0



Overview

The PAN1781 is a Bluetooth 5 Low Energy (LE) module based on the Nordic nRF52820 single chip controller.

Features

- Surface mount type dimensions: 15.6 mm × 8.7 mm × 2 mm
- Drop-in replacement for PAN1026A and PAN1762
- Nordic nRF52820 featuring ARM Cortex®-M4 with 64 MHz
- Bluetooth 5 LE including LE 2M and LE Coded PHY
- Embedded 256 kB flash memory and 32 kB internal RAM
- 128-bit AES/ECB/CCM/AAR co-processor
- Up to 16 General Purpose I/O's (GPIO), which are shared with up to 2× SPI, 2× I²C, UART, COMP, QDEC, nRESET
- USB 2.0 full-speed device interface
- Built-in temperature sensor

Bluetooth

- LE 2 Mbps high speed PHY, LE long range coded PHY
- LE advertising extensions (advertising on 40 channels total)
- Channel selection algorithm #2
- LE secure connections
- Angle of arrival (AoA) and angle of departure (AoD) direction finding

Characteristics

- Typical sensitivity: -95 dBm at 1 Mb/s and -103 dBm at 125 kb/s
- Typical max. output power: 8 dBm, configurable from -20 dBm in 4 dB steps and -40 dBm in whisper mode
- Typical current consumption: 4.9 mA in Tx (at 0 dBm) and 4.7 mA in Rx mode
- Typical current consumption: 0.3 µA in System OFF mode, 1.2 µA with RTC wake up
- On-module DC/DC and LDO regulators with automated low current modes
- Voltage range: 1.7 V to 5.5 V
- Temperature range: -40 °C to 85 °C

Block Diagram

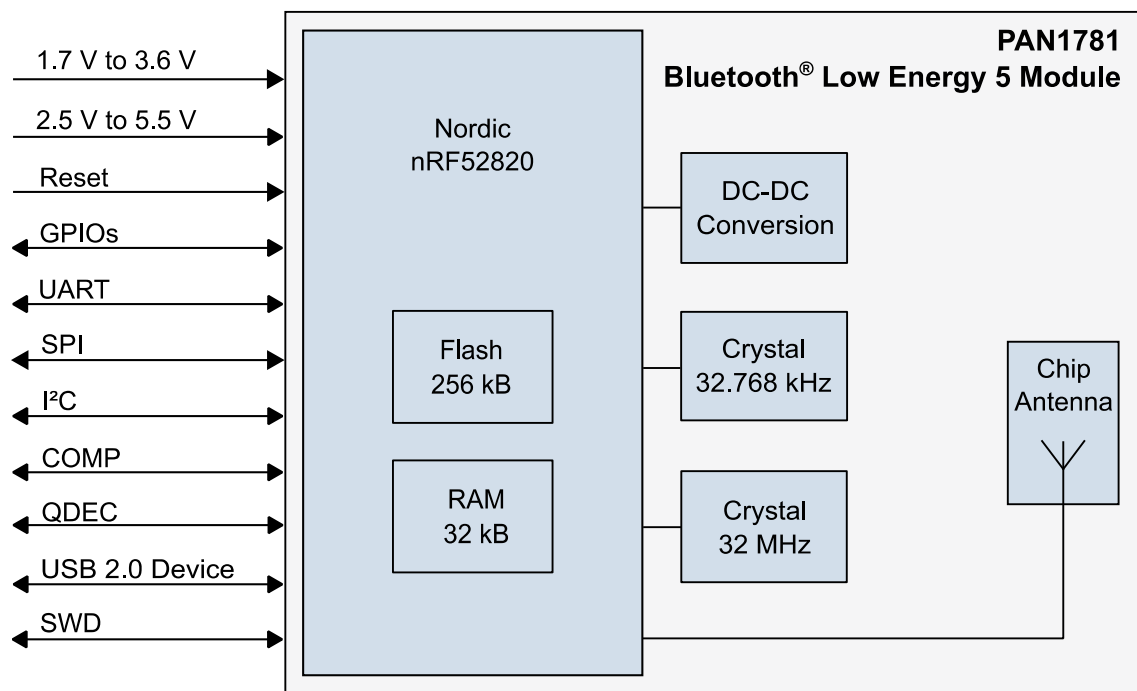

By purchase of any of the products described in this document the customer accepts the document's validity and declares their agreement and understanding of its contents and recommendations. Panasonic Industrial Devices Europe GmbH (Panasonic) reserves the right to make changes as required at any time without notification. Please consult the most recently issued Product Specification before initiating or completing a design.

© Panasonic Industrial Devices Europe GmbH 2021.

This specification sheet is copyrighted. Reproduction of this document is permissible only if reproduction is without alteration and is accompanied by all associated warranties, conditions, limitations, and notices. Do not disclose it to a third party.

All rights reserved.

This Product Specification does not lodge the claim to be complete and free of mistakes.

Document Acceptance

By signing the Product Specification, you acknowledge that you are a legal representative for your company and that you understand and accept the validity of the contents herein.

If the signed version of the Product Specification has not been returned to Panasonic within 30 days after receipt of the product, the specification or approval sheet shall be deemed to be accepted by you.

Engineering Samples (ES)

If Engineering Samples are delivered to the customer, these samples have the status "Engineering Samples". This means that the design of this product is not yet concluded. Engineering Samples may be partially or fully functional, and they may differ from the published Product Specification.

Engineering Samples are not qualified and they are not to be used for reliability testing or series production.

Disclaimer

The customer acknowledges that samples may deviate from the Product Specification and may bear defects due to their status of development and the lack of qualification mentioned above.

Panasonic rejects any liability or product warranty for Engineering Samples. In particular, Panasonic disclaims liability for damages caused by:

- The use of the Engineering Sample other than for evaluation purposes, particularly the installation or integration in another product to be sold by the customer,
- Deviation or lapse in function of the Engineering Sample,
- Improper use of the Engineering Sample.

Panasonic Industrial Devices Europe GmbH disclaims any liability for consequential and incidental damages. In case of any queries regarding the Engineering Samples, please contact your local sales partner or the related product manager.

Table of Contents

1	About This Document	5
1.1	Purpose and Audience	5
1.2	Revision History.....	5
1.3	Use of Symbols	5
1.4	Related Documents	5
2	Overview	6
2.1	Block Diagram	7
2.2	Pin Configuration	8
2.3	Peripherals	10
2.4	Bluetooth Features	10
3	Detailed Description	11
3.1	Dimensions.....	11
3.2	Footprint	12
3.3	Packaging.....	13
3.4	Case Marking	16
4	Specification	17
4.1	Default Test Conditions	17
4.2	Absolute Maximum Ratings.....	17
4.3	Recommended Operating Conditions.....	18
4.4	Current Consumption.....	18
4.5	Bluetooth	19
4.6	Reliability Tests	20
4.7	Recommended Soldering Profile	21
5	Cautions	22
5.1	Design Notes	22
5.2	Installation Notes	22
5.3	Usage Condition Notes.....	23
5.4	Storage Notes.....	23
5.5	Safety Cautions	23
5.6	Other Cautions	24
5.7	Restricted Use	25
6	Regulatory and Certification Information	26
6.1	General Certification Information	26
6.2	Federal Communications Commission (FCC) for US	26
6.3	Innovation, Science, and Economic Development (ISED) for Canada	29
6.4	European Conformity According to RED (2014/53/EU)	32
6.5	Bluetooth	33
6.6	RoHS and REACH Declaration	33
7	Appendix	34
7.1	Ordering Information.....	34
7.2	Contact Details	35

1 About This Document



1.1 Purpose and Audience

This Product Specification provides details on the functional, operational, and electrical characteristics of the Panasonic PAN1781 module. It is intended for hardware design, application, and Original Equipment Manufacturers (OEM) engineers. The product is referred to as “the PAN1781” or “the module” within this document.

1.2 Revision History

Revision	Date	Modifications/Remarks
1.0	2021-04-20	First version

1.3 Use of Symbols

Symbol	Description
	<p>Note</p> <p>Indicates important information for the proper use of the product. Non-observance can lead to errors.</p>
	<p>Attention</p> <p>Indicates important notes that, if not observed, can put the product’s functionality at risk.</p>
⇒ [chapter number] [chapter title]	<p>Cross reference</p> <p>Indicates cross references within the document.</p> <p>Example:</p> <p>Description of the symbols used in this document ⇒ 1.3 Use of Symbols.</p>

1.4 Related Documents

For related documents please refer to the Panasonic website ⇒ 7.2.2 Product Information.

2 Overview

The PAN1781 is a Bluetooth 5 Low Energy (LE) module based on the Nordic nRF52820 single chip controller.

The Bluetooth 5 features additionally a higher symbol rate of 2 Mbps using the high speed LE 2M PHY or a significantly longer range using the LE coded PHY at 500 kb/s or 125 kb/s. The new channel selection algorithm (CSA#2) improves the performance in high interference environments. Furthermore, the new LE advertising extensions allow for much larger amounts of data to be broadcasted in connectionless scenarios.

An output power of up to 8 dBm and the high sensitivity of the nRF52820 in combination with the LE coded PHY make the module very attractive in applications, where a long range is required.

In addition the ultra-low current consumption of the PAN1781 makes the module an ideal choice for battery powered devices.

With the Cortex M4 processor, 32 kB RAM, and the built-in 256 kB flash memory, the PAN1781 can easily be used in standalone mode, thereby eliminating the need for an external processor, saving complexity, space, and cost.

The PAN1781 also supports angle of arrival (AoA) and angle of departure (AoD) direction finding using Bluetooth.

A 128-bit AES/ECB/CCM/AAR co-processor may be used for on-the-fly packet encryption.

For related documents please refer to [⇒ 7.2.2 Product Information](#).

For further information on the variants and versions please refer to [⇒ 7.1 Ordering Information](#).

2.1 Block Diagram

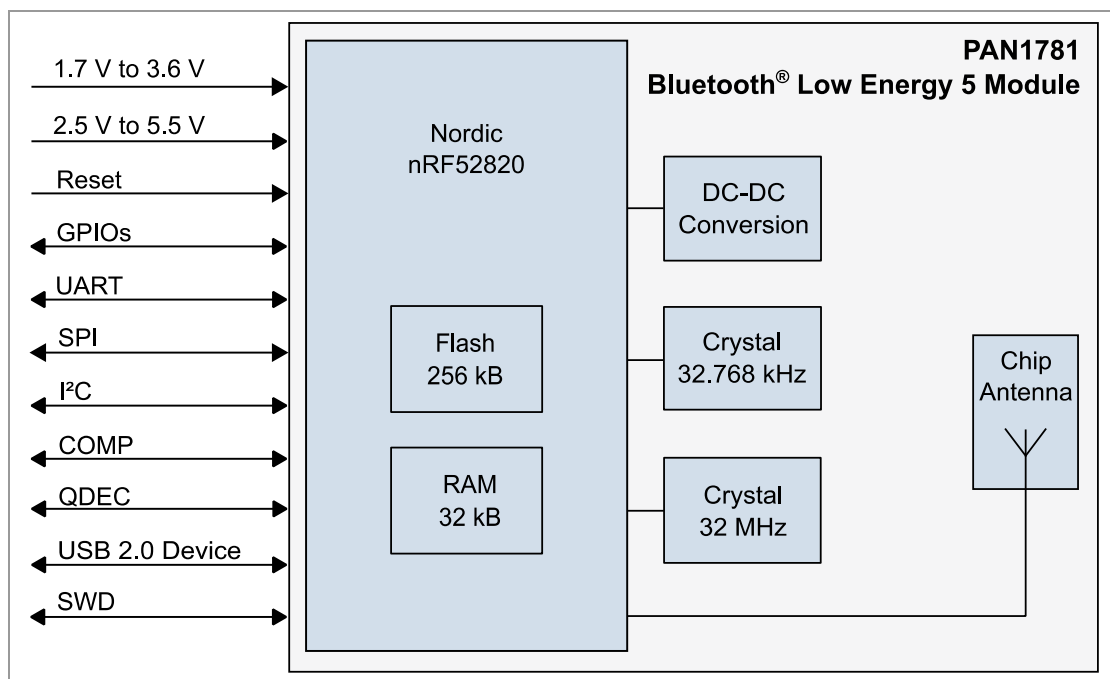

2.2 Pin Configuration

Pin Assignment

Top View

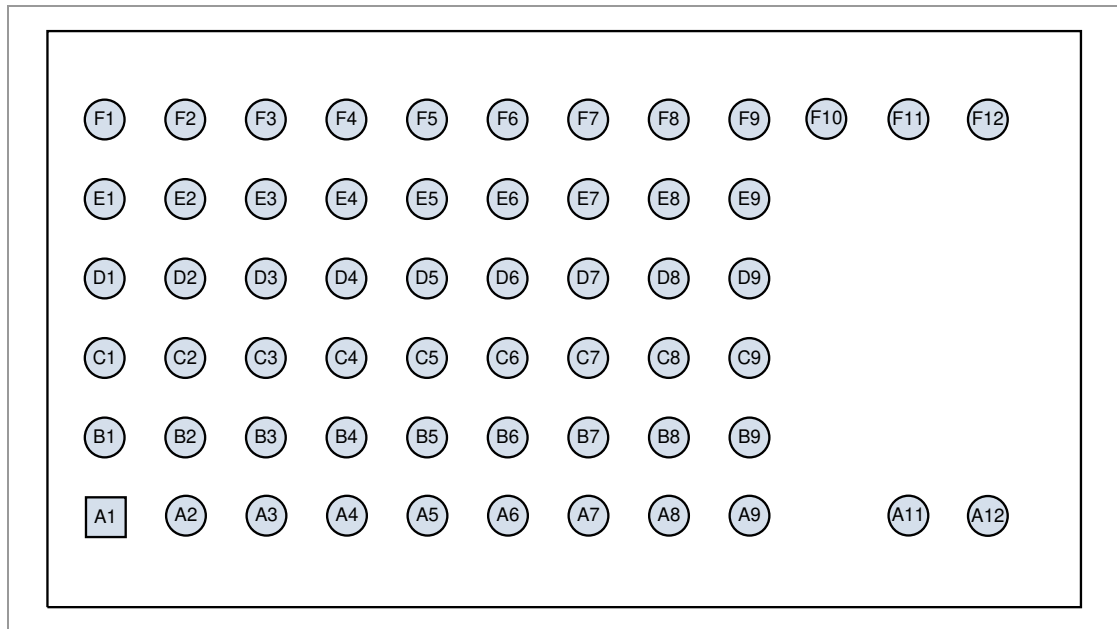

Pin Functions

No.	Pin Name	Pin Type	Description
A1	GND	Ground	Connect to ground
A2	P0.03/AIN1	Digital BI/ Analog Input	GPIO/Analogue signal to COMP
A3	nRESET	Digital BI	Low active RESET
A4	NC	NC	Do not connect
A5	V _{CC}	Power	Connect 1.7 V to 3.6 V in Normal Voltage Mode
			Leave open in High Voltage Mode
A6	V _{DDH}	Power	Connect to V _{CC} (1.7 V to 3.6 V) in Normal Voltage Mode
			Connect 2.5 V to 5.5 V in High Voltage Mode
A7	GND	Ground	Connect to ground
A8	P0.16	Digital BI	GPIO
A9	GND	Ground	Connect to ground
A11	GND	Ground	Connect to ground, necessary for antenna to stay tuned
A12	GND	Ground	Connect to ground, necessary for antenna to stay tuned
B1	P0.29	Digital BI	GPIO
B2	P0.04/AIN2	Digital BI / Analog Input	GPIO/Analogue signal to COMP

No.	Pin Name	Pin Type	Description
B3	NC	NC	Do not connect
B4	NC	NC	Do not connect
B5	UART_RTS	Digital BI	GPIO or UART_RTS
B6	UART_CTS	Digital BI	GPIO or UART_CTS
B7	NC	NC	Do not connect
B8	NC	NC	Do not connect
B9	NC	NC	Do not connect
C1	NC	NC	Do not connect
C2	NC	NC	Do not connect
C3	P0.05/AIN3	Digital BI	Digital BI/Analogue signal to COMP
C4	SWDIO	Digital BI	Serial Wire Data I/O
C5	SWDCLK	Digital IN	Serial Wire Data Clock
C6	P0.15	Digital BI	GPIO
C7	NC	NC	Do not connect
C8	GND	Ground	Connect to ground
C9	GND	Ground	Connect to ground
D1	NC	NC	Do not connect
D2	NC	NC	Do not connect
D3	NC	NC	Do not connect
D4	NC	NC	Do not connect
D5	NC	NC	Do not connect
D6	NC	NC	Do not connect
D7	GND	Ground	Connect to ground
D8	GND	Ground	Connect to ground
D9	GND	Ground	Connect to ground
E1	P0.14	Digital BI	GPIO
E2	P0.20	Digital BI	GPIO
E3	V _{BUS}	Power	USB-Bus Supply Voltage Connect if USB is used
E4	NC	NC	Do not connect
E5	NC	NC	Do not connect
E6	UART_RXD	Digital BI	GPIO or UART_RXD
E7	NC	NC	Do not connect

No.	Pin Name	Pin Type	Description
E8	GND	Ground	Connect to ground
E9	GND	Ground	Connect to ground
F1	GND	Ground	Connect to ground
F2	NC	NC	Do not connect
F3	DP	Digital BI	USB differential line with polarity +
F4	DM	Digital BI	USB differential line with polarity -
F5	P0.02/AIN0	Digital BI/Analog Input	GPIO/Analogue signal to COMP
F6	P0.17	Digital BI	GPIO
F7	UART_TXD	Digital BI	GPIO or UART_TXD
F8	P0.28	Digital BI	GPIO
F9	GND	Ground	Connect to ground
F10	NC	NC	Do not connect
F11	GND	Ground	Connect to ground, necessary for antenna to stay tuned
F12	GND	Ground	Connect to ground, necessary for antenna to stay tuned

2.3 Peripherals

- Full speed USB 2.0 device controller
- UART (2 or 4 wire with CTS/RTS, 1 200 up to 1 M baud)
- 2x I2C (100 kHz or 400 kHz)
- 2x SPI (125 kbps up to 8 Mbps) Master and Slave Mode
- PWM 4x 32-bit timer
- AES CCM mode encryption on-the-fly
- 4 channel Comparator
- Quadrature decoder QDEC
- Temperature sensor
- 2x Real-time counter RTC
- Watchdog timer
- 16 PIOs including RESET, 4-wire UART
- Integrated 32 kHz crystal
- Serial wire debug and program interface

2.4 Bluetooth Features

- Bluetooth 5 LE
- Supports Bluetooth 5 LE high speed and long range modes
- AoA and AoD direction finding

3 Detailed Description

3.1 Dimensions



All dimensions are in millimeters.

Top View

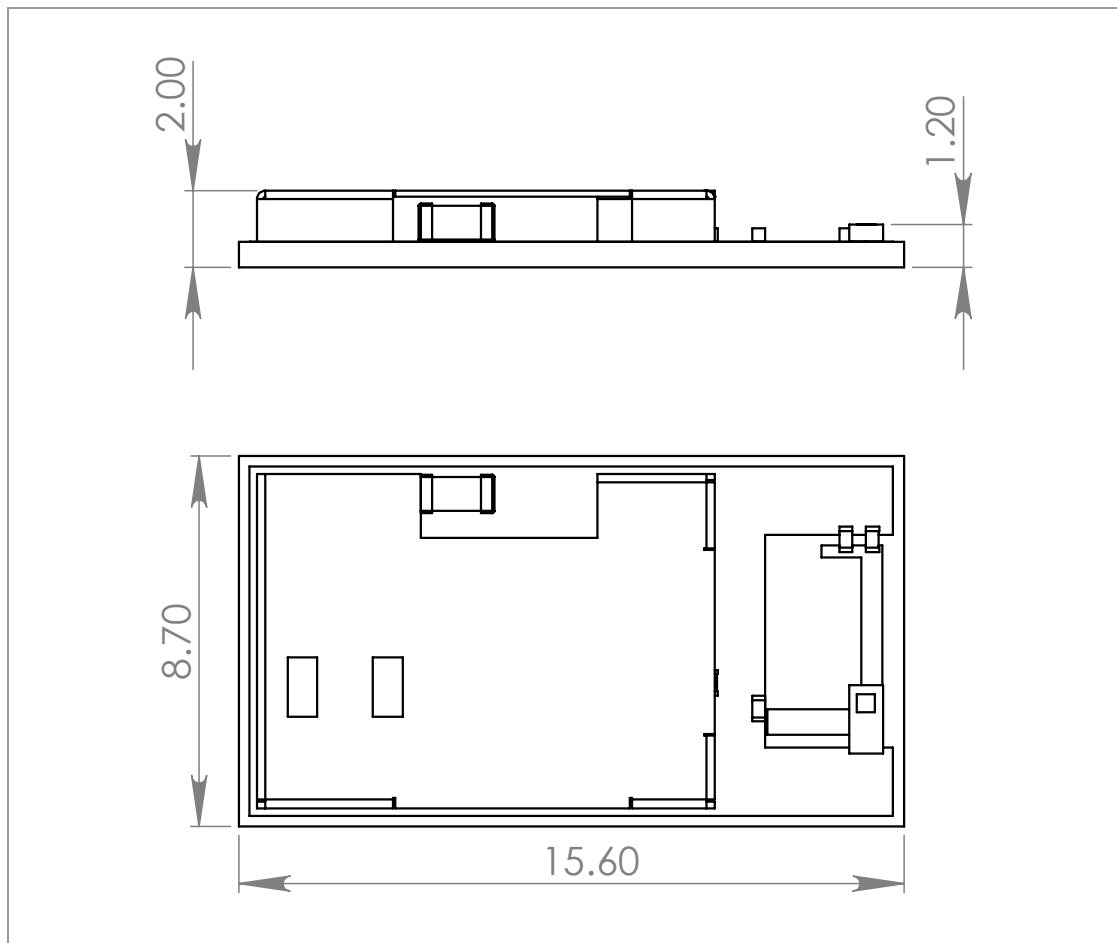

No.	Item	Dimension	Tolerance	Remark
1	Width	8.70	±0.3	
2	Length	15.60	±0.3	
3	Height	2.00	±0.2	With case

3.2 Footprint



All dimensions are in millimeters.

Top View

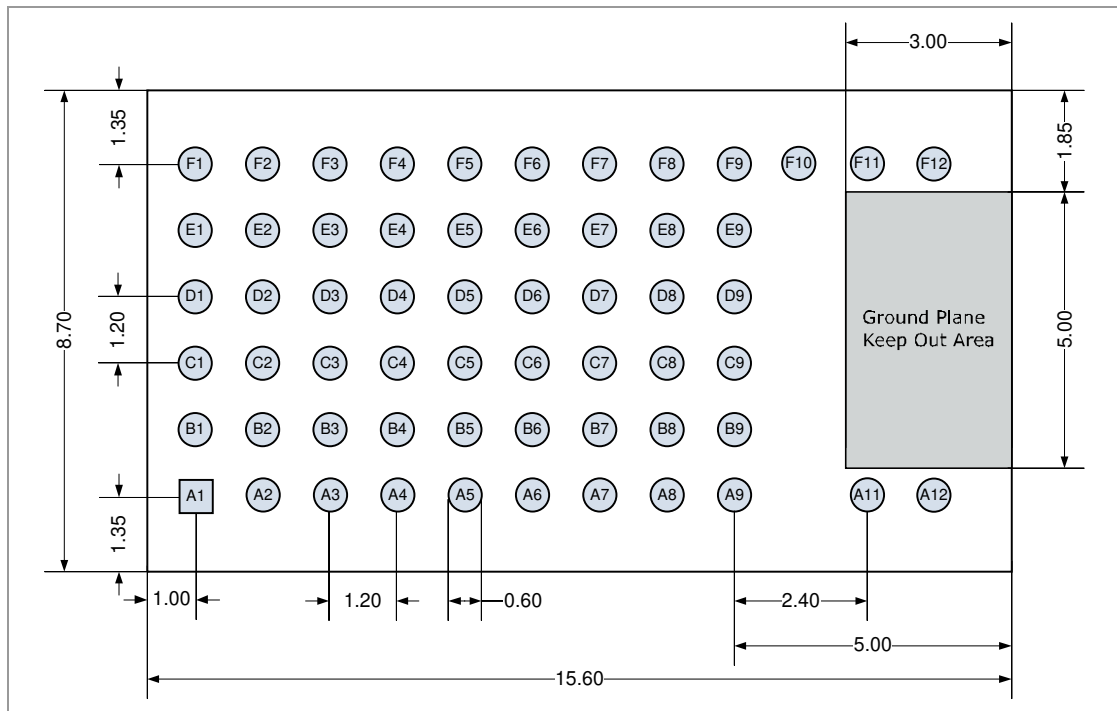

3.3 Packaging

The module is a mass production status product and will be delivered in the package described below.

3.3.1 Tape Dimensions

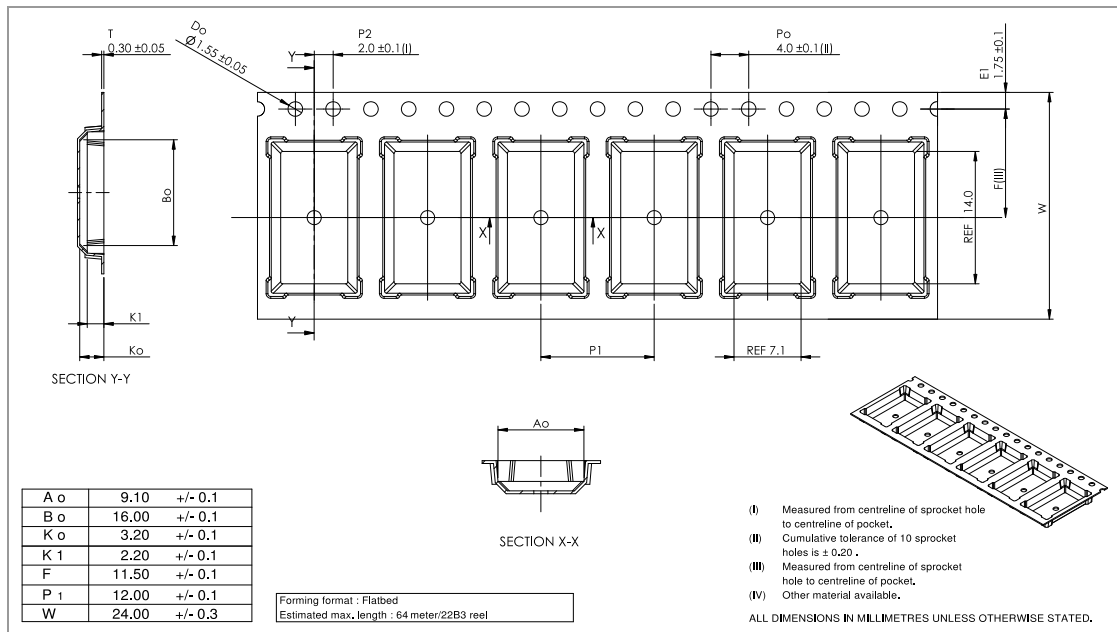

3.3.2 Packing in Tape

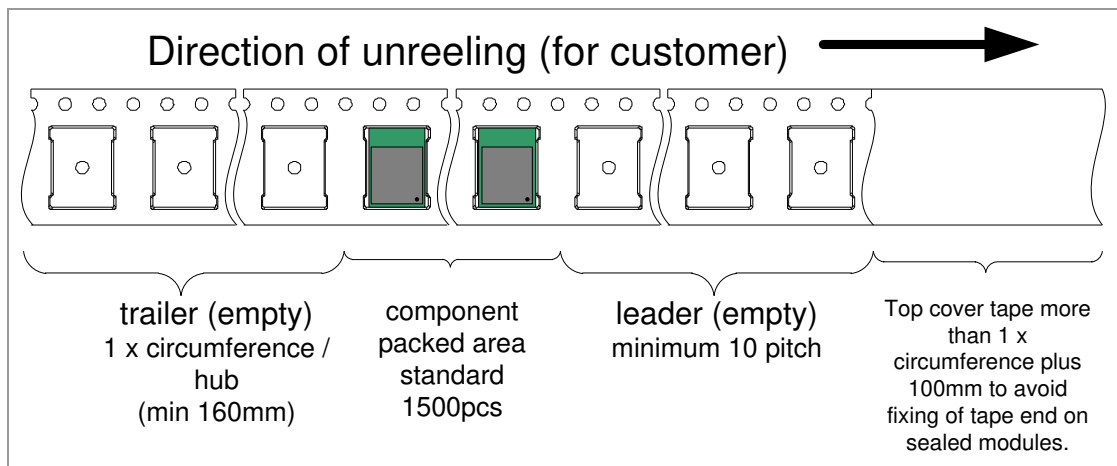

Empty spaces in the component packed area shall be less than two per reel and those spaces shall not be consecutive.

The top cover tape shall not be found on reel holes and it shall not stick out from the reel.

3.3.3 Component Direction

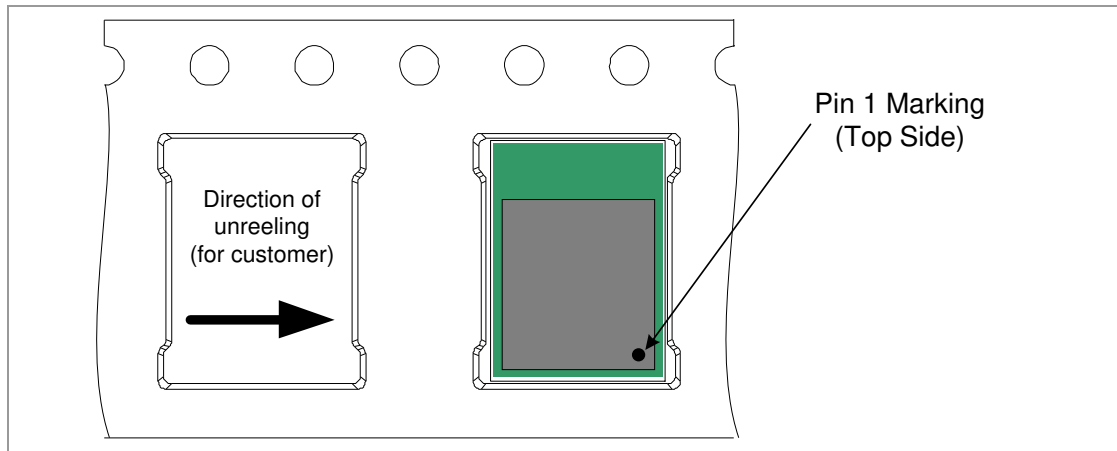

3.3.4 Reel Dimension

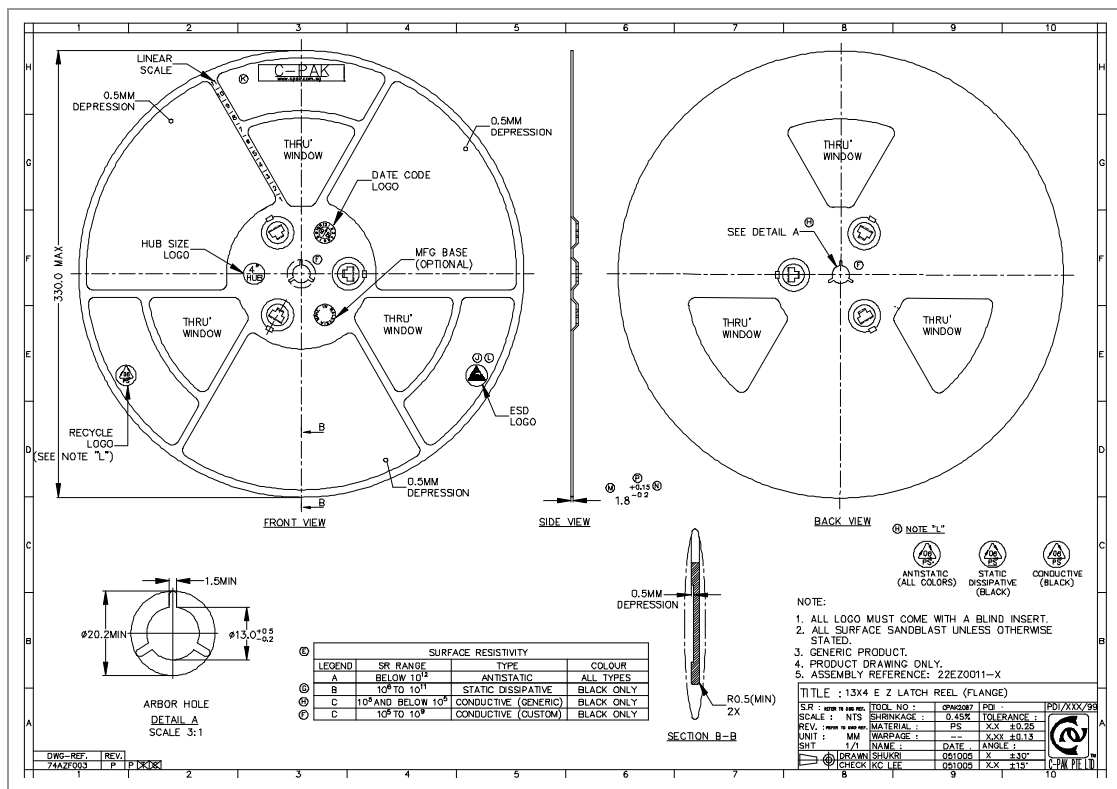

3.3.5 Package Label

Example:

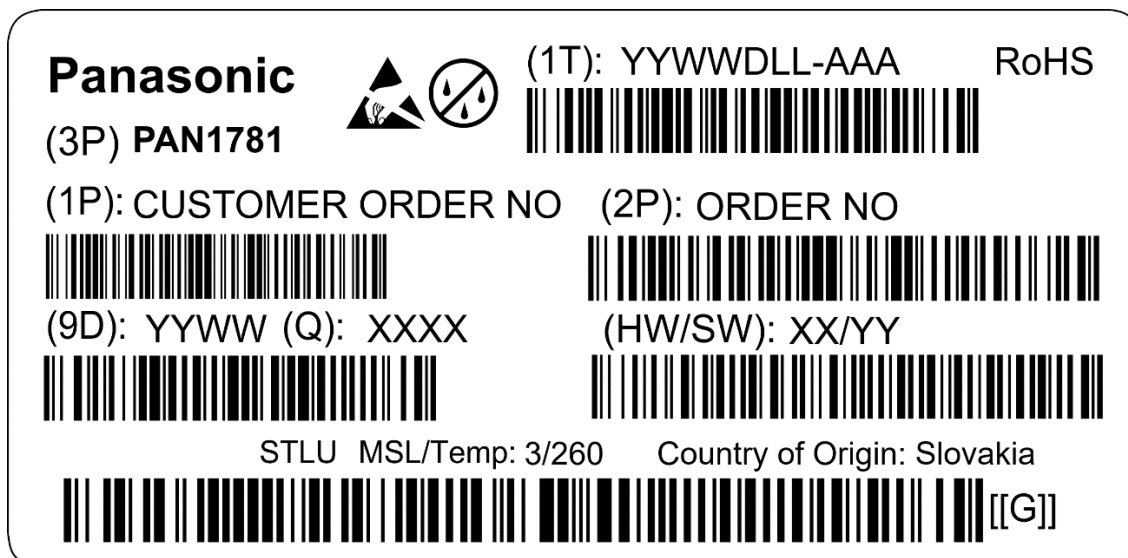

(1T)	Lot code
(1P)	Customer order number, if applicable
(2P)	Order number
(9D)	Date code
(Q)	Quantity
(HW/SW)	Hardware/software version

3.3.6 Total Package

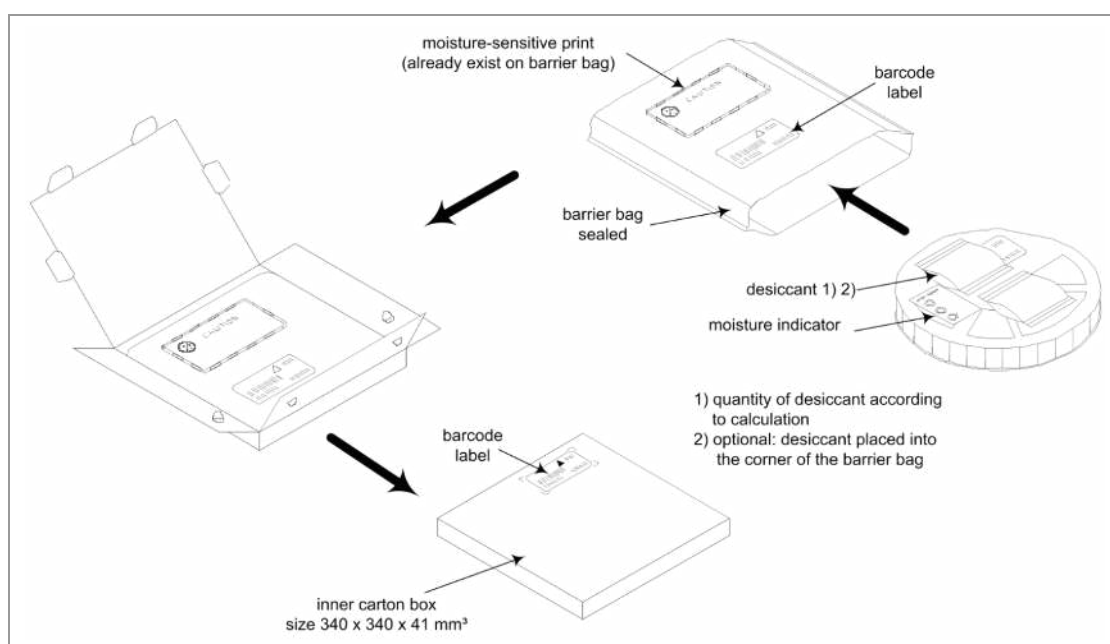

3.4 Case Marking

Example:

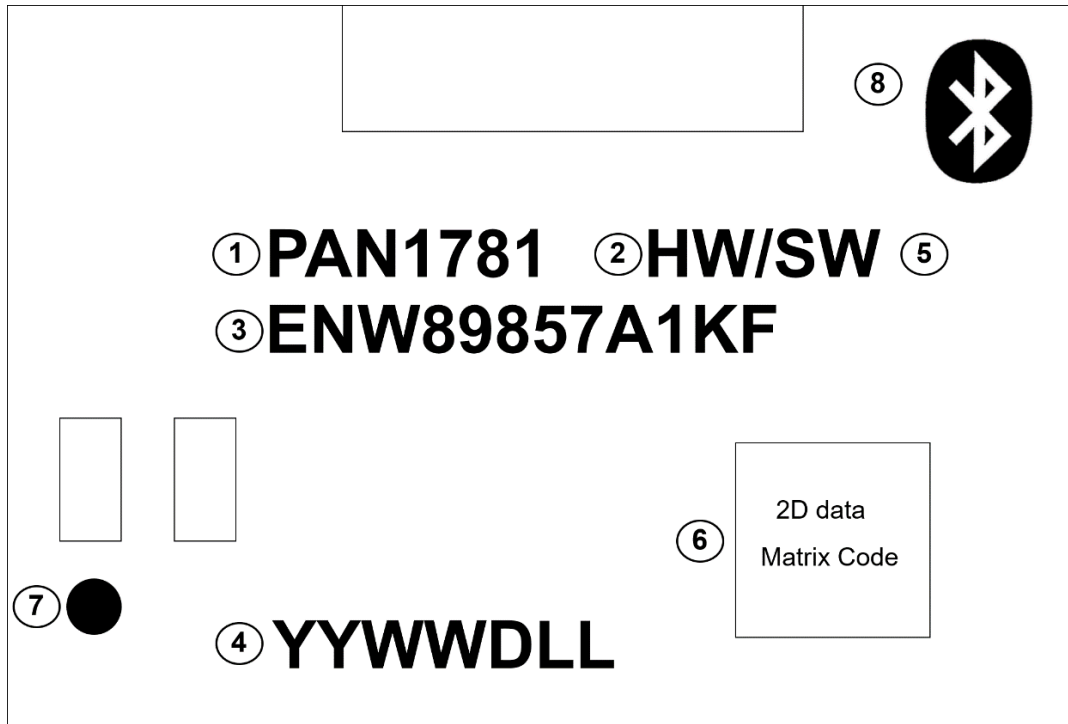

- 1 Brand name
- 2 Hardware/software version
- 3 Order number
- 4 Lot code
- 5 Status: ES or empty for MP
- 6 2D barcode, for internal usage only
- 7 Marking for Pin 1
- 8 Bluetooth logo

4 Specification



All specifications are over temperature and process, unless indicated otherwise.

4.1 Default Test Conditions



Temperature: 25 °C ± 10 °C
Humidity: 40 % to 85 % RH
Supply Voltage: 3.3 V

4.2 Absolute Maximum Ratings



The maximum ratings may not be exceeded under any circumstances, not even momentarily or individually, as permanent damage to the module may result.

Symbol	Parameter	Condition	Min.	Typ.	Max.	Unit
V _{DD}	Normal Supply Voltage		-0.3		3.9	V
V _{DDH}	High Supply Voltage		-0.3		5.8	
V _{BUS}	USB Bus Voltage		-0.3		5.8	
I/O Pin	Voltage on any Pin	V _{DD} ≤ 3.6 V	-0.3		V _{DD} + 0.3	
		V _{DD} > 3.6 V	-0.3		3.9	
ESD	ESD Robustness	HBM 2			±2 000	
		CDM			500	
MSL	Moisture Sensitivity Level				3	
P _{RF}	RF Input Level				10	dBm
T _{STOR}	Storage Temperature		-40		125	°C

4.3 Recommended Operating Conditions



The maximum ratings may not be exceeded under any circumstances, not even momentarily or individually, as permanent damage to the module may result.

Symbol	Parameter	Condition	Min.	Typ.	Max.	Unit
V _{DD} (LV Mode)	Supply Voltage		1.7		3.6	V
t _{R_VDD}	Supply Rise Time	0 V to 1.7 V			60	ms
V _{DD-POR}	Supply Voltage	Power on Reset active	1.75			
V _{DDH} (HV Mode)	Supply Voltage	V _{DDH} (optional)	2.5		5.5	V
t _{R_VDDH}	Supply Rise Time	0 V to 3.7 V			100	ms
V _{BUS}	VBUS USB Supply Voltage	V _{BUS} (optional)	4.35		5.5	V
V _{I/O}	Max I/O Pin Voltage	V _{DD} ≤ 3.6 V	-0.3		V _{DD} + 0.3	V
		V _{DD} ≥ 3.6 V			V _{DD} + 3.9	
TA	Operating Temperature		-40	25	85	°C

4.4 Current Consumption



The current consumption depends on the user scenario and on the setup and timing in the power modes.

Assume V_{DD} = 3 V, T_{amb} = 25 °C, if nothing else stated, DC/DC enabled.

Parameter	Condition	Min.	Typ.	Max.	Unit
Sleep Mode	No RAM retention, Wake on Reset, SYS OFF		0.3		μA
	Full RAM retention, Wake on Reset, SYS OFF		0.5		μA
	No RAM retention, Wake on any event, SYS ON		0.4		μA
	Full RAM retention, Wake on any event, SYS ON		0.8		μA
	No RAM retention, Wake on RTC, SYS ON		1.2		μA
CPU executing CoreMark	Running from RAM		2.1		mA
	Running from Flash		2.1		mA
Rx Current	Rx only 1 Mbps Bluetooth LE Mode		4.7		mA

Parameter	Condition	Min.	Typ.	Max.	Unit
Tx Current	8 dBm Tx only		14		mA
	4 dBm Tx only		9.4		mA
	0 dBm Tx only		4.9		mA
	-4 dBm Tx only		3.8		mA
	-8 dBm Tx only		3.4		mA
	-12 dBm Tx only		3.1		mA
	-16 dBm Tx only		2.9		mA
	-20 dBm Tx only		2.7		mA
	-40 dBm Tx only		2.3		mA

4.5 Bluetooth

Parameter	Specification
Frequency	2 402 MHz to 2 480 MHz
Data Rate	2 Mbps, 1 Mbps, 500 kbps, 125 kbps
Number of Channels	40: 37 data/3 advertising (0, 12, 39)
Receive Sensitivity	-103 dBm (125 kbps Bluetooth LE Mode), -95 dBm (1 Mbps Bluetooth LE Mode), -92 (2 Mbps Bluetooth LE Mode)
Output Power	-40 dBm to +8 dBm
Link Budget	Up to 111 dB

4.6 Reliability Tests

The measurement should be done after the test module has been exposed to room temperature and humidity for one hour.

No.	Item	Limit	Condition
1	Variable Vibration Test	Electrical parameters should be within specification	Freq.: 20 Hz~2 000 Hz, Acc.: 17 G to 50 G, Sweep: 8 min, 2 hours, For: XYZ axis
2	Shock Drop Test		Drop parts on concrete from a height of 1 m for 3 times
3	Heat-Shock/ Temperature Cycling Test		At -40 °C and 85 °C for 1 h/cycle Total = 300 cycles
4	Temperature Humidity Bias Test		At 60 °C, 85 % r. H., 300 h
5	Low Temperature Storage Life Test		At -40 °C, 300 h
6	High Temperature Storage Life Test		At 85 °C, 300 h

4.7 Recommended Soldering Profile



- Reflow permissible cycles: 2
- Opposite side reflow is prohibited due to module weight
- More than 75 percent of the soldering area shall be coated by solder
- The soldering profiles should be adhered to in order to prevent electrical or mechanical damage
- Soldering profile assumes lead-free soldering

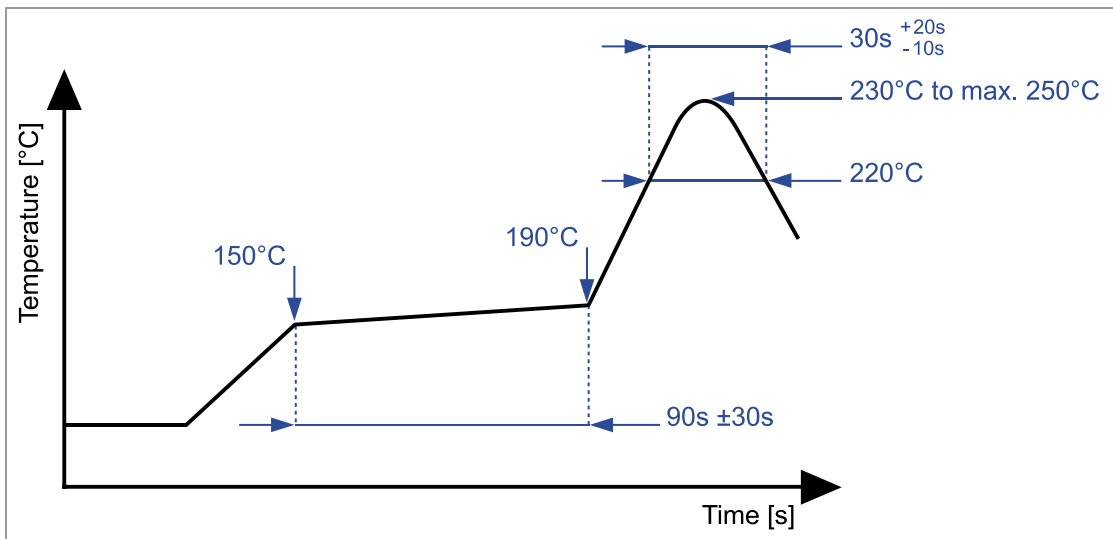

5 Cautions



Failure to follow the guidelines set forth in this document may result in degrading of the module functions and damage to the module.

5.1 Design Notes

1. Follow the conditions written in this specification, especially the control signals of this module.
2. The supply voltage should abide by the maximum ratings (⇒ [4.2 Absolute Maximum Ratings](#)).
3. The supply voltage must be free of AC ripple voltage (for example from a battery or a low noise regulator output). For noisy supply voltages, provide a decoupling circuit (for example a ferrite in series connection and a bypass capacitor to ground of at least 47 μ F directly at the module).
4. This module should not be mechanically stressed when installed.
5. Keep this module away from heat. Heat is the major cause of decreasing the life time of these modules.
6. Avoid assembly and use of the target equipment in conditions where the module temperature may exceed the maximum tolerance.
7. Keep this module away from other high frequency circuits.
8. Refer to the recommended pattern when designing a board.

5.2 Installation Notes

1. Reflow soldering is possible twice based on the conditions set forth in ⇒ [4.7 Recommended Soldering Profile](#). Set up the temperature at the soldering portion of this module according to this reflow profile.
2. Carefully position the module so that the heat will not burn into printed circuit boards or affect other components that are susceptible to heat.
3. Carefully locate the module, to avoid an increased temperature caused by heat generated by neighboring components.
4. If a vinyl-covered wire comes into contact with the module, the wire cover will melt and generate toxic gas, damaging the insulation. Never allow contact between a vinyl cover and these modules to occur.
5. This module should not be mechanically stressed or vibrated when reflowed.
6. To repair the board by hand soldering, follow the conditions set forth in this chapter.
7. Do not wash this product.
8. Pressing on parts of the metal cover or fastening objects to the metal will cause damage to the module.

5.3 Usage Condition Notes

1. Take measures to protect the module against static electricity.
If pulses or transient loads (a large load, which is suddenly applied) are applied to the modules, check and evaluate their operation before assembly of the final products.
2. Do not use dropped modules.
3. Do not touch, damage, or soil the pins.
4. Follow the recommended condition ratings about the power supply applied to this module.
5. Electrode peeling strength: Do not apply a force of more than 4.9 N in any direction on the soldered module.
6. Pressing on parts of the metal cover or fastening objects to the metal cover will cause damage.
7. These modules are intended for general purpose and standard use in general electronic equipment, such as home appliances, office equipment, information, and communication equipment.

5.4 Storage Notes

1. The module should not be stressed mechanically during storage.
2. Do not store these modules in the following conditions or the performance characteristics of the module, such as RF performance will be adversely affected:
 - Storage in salty air or in an environment with a high concentration of corrosive gas, such as Cl₂, H₂S, NH₃, SO₂, or NO_x,
 - Storage in direct sunlight,
 - Storage in an environment where the temperature may be outside the range of 5 °C to 35 °C, or where the humidity may be outside the 45 % to 85 % range,
 - Storage of the modules for more than one year after the date of delivery storage period: Please check the adhesive strength of the embossed tape and soldering after 6 months of storage.
3. Keep this module away from water, poisonous gas, and corrosive gas.
4. This module should not be stressed or shocked when transported.
5. Follow the specification when stacking packed crates (max. 10).

5.5 Safety Cautions

These specifications are intended to preserve the quality assurance of products and individual components.

Before use, check and evaluate the operation when mounted on your products. Abide by these specifications without deviation when using the products. These products may short-circuit. If electrical shocks, smoke, fire, and/or accidents involving human life are anticipated when a short circuit occurs, provide the following failsafe functions as a minimum:

1. Ensure the safety of the whole system by installing a protection circuit and a protection device.
2. Ensure the safety of the whole system by installing a redundant circuit or another system to prevent a single fault causing an unsafe status.

5.6 Other Cautions

1. Do not use the module for other purposes than those listed in section ⇒ [5.3 Usage Condition Notes](#).
2. Be sure to provide an appropriate fail-safe function on your product to prevent any additional damage that may be caused by the abnormal function or the failure of the module.
3. This module has been manufactured without any ozone chemical controlled under the Montreal Protocol.
4. These modules are not intended for use under the special conditions shown below. Before using these modules under such special conditions, carefully check their performance and reliability under the said special conditions to determine whether or not they can be used in such a manner:
 - In liquid, such as water, salt water, oil, alkali, or organic solvent, or in places where liquid may splash,
 - In direct sunlight, outdoors, or in a dusty environment,
 - In an environment where condensation occurs,
 - In an environment with a high concentration of harmful gas (e. g. salty air, HCl, Cl₂, SO₂, H₂S, NH₃, and NO_x).
5. If an abnormal voltage is applied due to a problem occurring in other components or circuits, replace these modules with new modules, because they may not be able to provide normal performance even if their electronic characteristics and appearances appear satisfactory.



For further information please refer to the Panasonic website ⇒ [7.2.2 Product Information](#).

5.7 Restricted Use

5.7.1 Life Support Policy

This Panasonic Industrial Devices Europe GmbH product is not designed for use in life support appliances, devices, or systems where malfunction can reasonably be expected to result in a significant personal injury to the user, or as a critical component in any life support device or system whose failure to perform can be reasonably expected to cause the failure of the life support device or system, or to affect its safety or effectiveness.

Panasonic customers using or selling these products for use in such applications do so at their own risk and agree to fully indemnify Panasonic Industrial Devices Europe GmbH for any damages resulting.

5.7.2 Restricted End Use

This Panasonic Industrial Devices Europe GmbH product is not designed for any restricted activity that supports the development, production, handling usage, maintenance, storage, inventory or proliferation of any weapons or military use.

Transfer, export, re-export, usage or reselling of this product to any destination, end user or any end use prohibited by the European Union, United States or any other applicable law is strictly prohibited.

6 Regulatory and Certification Information

6.1 General Certification Information



Regulatory certifications are valid for the following radio relevant software:

- Nordic SoftDevices S112, S113, or S140
- Bluetooth Specification 5



For further certification requests for other radio software please contact Panasonic ⇒ [7.2 Contact Details](#).

6.2 Federal Communications Commission (FCC) for US

6.2.1 FCC Notice



The PAN1781 including the antennas, which are listed in ⇒ [6.2.5 Approved Antenna List](#), complies with Part 15 of the FCC Rules.

The device meets the requirements for modular transmitter approval as detailed in FCC public Notice DA00-1407. The transmitter operation is subject to the following two conditions:

1. This device may not cause harmful interference, and
2. This device must accept any interference received, including interference that may cause undesired operation.

6.2.2 Caution



The FCC requires the user to be notified that any changes or modifications made to this device that are not expressly approved by Panasonic Industrial Devices Europe GmbH may void the user's authority to operate the equipment.



This equipment has been tested and found to comply with the limits for a Class B digital device, pursuant to Part 15 of the FCC Rules.

These limits are designed to provide reasonable protection against harmful interference in a residential installation. This equipment generates uses and can radiate radio frequency energy and, if not installed and used in accordance with the instructions, may cause harmful interference to radio communications.

However, there is no guarantee that interference will not occur in a particular installation. If this equipment does cause harmful interference to radio or television reception, which can be determined by turning the equipment off and on, the user is encouraged to try to correct the interference by one or more of the following measures:

- Reorient or relocate the receiving antenna,
- Increase the separation between the equipment and receiver,
- Connect the equipment into an outlet on a circuit different from that to which the receiver is connected,
- Consult the dealer or an experienced radio/TV technician for help.

6.2.3 Label Requirements



The OEM must ensure that FCC labelling requirements are met. This includes a clearly visible label on the outside of the OEM enclosure specifying the appropriate Panasonic FCC identifier for this product as well as the FCC Notice above.

The FCC identifier is **FCC ID: T7V1781**.

This FCC identifier is valid for the PAN1781. The end product must in any case be labelled on the exterior with:

"Contains FCC ID: T7V1781".

Due to the PAN1781 model size, the FCC identifier is displayed on the product package and in the installation instruction only. It cannot be displayed readable on the module's label due to the limited size.

6.2.4 Antenna Warning

This antenna warning refers to the test device with the model number PAN1781

⇒ [7.1 Ordering Information](#)

The device is tested with a standard SMA connector and with the antenna listed below. When integrated into the OEM's product, these fixed antennas require installation preventing end users from replacing them with non-approved antennas. Any antenna not in the following table must be tested to comply with FCC Section 15.203 for unique antenna connectors and with Section 15.247 for emissions. The FCC identifier for the device with the antenna listed in ⇒ [6.2.5 Approved Antenna List](#) is the same (**FCC ID: T7V1781**).

6.2.5 Approved Antenna List

Item	Part Number	Manufacturer	Frequency Band	Type	Max. Gain (dBi)
1	ANT016008LCS2442MA1	TDK	2.4 GHz	Chip antenna	+2.0

6.2.6 RF Exposure



To comply with FCC RF Exposure requirements, the OEM must ensure that only antennas from the Approved Antenna List are installed ⇒ [6.2.5 Approved Antenna List](#).

The preceding statement must be included as a "CAUTION" statement in manuals for products operating with the approved antennas in the previous table to alert users on FCC RF Exposure compliance.

Any notification to the end user of installation or removal instructions about the integrated radio module is not allowed.

The radiated output power of the PAN1781 with a mounted ceramic antenna (**FCC ID: T7V1781**) is below the FCC radio frequency exposure limits. Nevertheless, the PAN1781 shall be used in such a manner that the potential for human contact during normal operation is minimized.

End users may not be provided with the module installation instructions. OEM integrators and end users must be provided with transmitter operating conditions for satisfying RF exposure compliance.

6.3 Innovation, Science, and Economic Development (ISED) for Canada

English

The PAN1781 is licensed to meet the regulatory requirements of ISED.

License ID: **IC: 216Q-1781**

HVIN: **ENW89857A1KF, ENW89857A2KF**

Manufacturers of mobile, fixed or portable devices incorporating this module are advised to clarify any regulatory questions and ensure compliance for SAR and/or RF exposure limits. Users can obtain Canadian information on RF exposure and compliance from www.ic.gc.ca.

This device has been designed to operate with the antennas listed in ⇒ [6.2.5 Approved Antenna List](#), having a maximum gain of +2.0 dBi. Antennas not included in this list or having a gain greater than +2.0 dBi are strictly prohibited for use with this device. The required antenna impedance is 50 ohms. The antenna used for this transmitter must not be co-located or operating in conjunction with any other antenna or transmitter.

Due to the model size, the IC identifier is displayed in the installation instruction only and it cannot be displayed on the module's label due to the limited size.



The end customer has to assure that the device has a distance of more than 10 mm from the human body under all circumstances.

If the end customer application intends to use the PAN1781 in a distance smaller 10 mm from the human body, SAR evaluation has to be repeated by the OEM.

The end customer equipment must meet the actual Safety/Health requirements according to ISED.

French

PAN1781 est garanti conforme aux dispositions réglementaires d'Industry Canada (ISED).

License: **IC: 216Q-1781**

HVIN: **ENW89857A1KF, ENW89857A2KF**

Il est recommandé aux fabricants d'appareils fixes, mobiles ou portables de consulter la réglementation en vigueur et de vérifier la conformité de leurs produits relativement aux limites d'exposition aux rayonnements radiofréquence ainsi qu'au débit d'absorption spécifique maximum autorisé.

Des informations pour les utilisateurs sur la réglementation Canadienne concernant l'exposition aux rayonnements RF sont disponibles sur le site www.ic.gc.ca.

Ce produit a été développé pour fonctionner spécifiquement avec les antennes listées dans le tableau ⇒ [6.2.5 Approved Antenna List](#), présentant un gain maximum de +2.0 dBi. Des antennes autres que celles listées ici, ou présentant un gain supérieur à +2.0 dBi ne doivent en aucune circonstance être utilisées en combinaison avec ce produit. L'impédance des antennes

compatibles est 50 Ohm. L'antenne utilisée avec ce produit ne doit ni être située à proximité d'une autre antenne ou d'un autre émetteur, ni être utilisée conjointement avec une autre antenne ou un autre émetteur.

En raison de la taille du produit, l'identifiant IC est fourni dans le manuel d'installation.



Le client final doit s'assurer que l'appareil se trouve en toutes circonstances à une distance de plus de 10 mm du corps humain.

Si le client final envisage une application nécessitant d'utiliser le PAN1781 à une distance inférieure à 10 mm du corps humain, alors le FEO doit répéter l'évaluation DAS.

L'équipement du client final doit répondre aux exigences actuelles de sécurité et de santé selon l'ISED.

6.3.1 IC Notice

English



The device PAN1781 (⇒ [7.1 Ordering Information](#)), including the antennas (⇒ [6.2.5 Approved Antenna List](#)), complies with Canada RSS-GEN Rules. The device meets the requirements for modular transmitter approval as detailed in RSS-Gen.

Operation is subject to the following two conditions:

1. This device may not cause harmful interference, and
2. This device must accept any interference received, including interference that may cause undesired operation.

French



Le présent appareil PAN1781 (⇒ [7.1 Ordering Information](#)), les antennes y compris (⇒ [6.2.5 Approved Antenna List](#)), est conforme aux CNR-Gen d'Industrie Canada applicables aux appareils radio exempts de licence.

L'exploitation est autorisée aux deux conditions suivantes:

1. L'appareil ne doit pas produire de brouillage, et
2. L'utilisateur de l'appareil doit accepter tout brouillage radioélectrique subi, même si le brouillage est susceptible d'en compromettre le fonctionnement.

6.3.2 Labeling Requirements

English



Labeling Requirements

The OEM must ensure that IC labelling requirements are met. This includes a clearly visible label on the outside of the OEM enclosure specifying the appropriate Panasonic IC identifier for this product as well as the IC Notice above.

The IC identifier is **IC: 216Q-1781**.

This IC identifier is valid for all PAN1781 modules ⇒ [7.1 Ordering Information](#). In any case, the end product must be labelled on the exterior with:

"Contains IC: 216Q-1781".

French



Obligations d'étiquetage

Les fabricants d'équipements d'origine (FEO) – en anglais Original Equipment Manufacturer (OEM) – doivent s'assurer que les obligations d'étiquetage IC du produit final sont remplies. Ces obligations incluent une étiquette clairement visible à l'extérieur de l'emballage externe, comportant l'identifiant IC du module Panasonic inclus, ainsi que la notification ci-dessus.

L'identifiant IC est **IC: 216Q-1781**.

Cet identifiant est valide pour tous les modules PAN1781 ⇒ [7.1 Ordering Information](#). Dans tous les cas les produits finaux doivent indiquer sur leur emballage externe la mention suivante:

"Contient IC: 216Q-1781".

6.4 European Conformity According to RED (2014/53/EU)

All modules described in this Product Specification comply with the standards according to the following LVD (2014/35/EU), EMC-D (2014/30/EU) together with RED (2014/53/EU) articles:

3.1a Safety/Health: EN 62368-1: 2014/AC: 2015/A11: 2017/AC:2017
EN 62479: 2010

3.1b EMC: EN 301 489-1 V2.2.3: (2019-11)
EN 301 489-17 V3.2.4: (2020-09)

3.2 Radio: EN 300 328 V2.2.2: (2019-07)

- Due to the model size, the CE marking is displayed on the product package and in the installation instruction only. It cannot be displayed conform to regulation (EU) No. 765/2008 in 5 mm height on the module's label due to the limited space.
- The RED EU Type Examination Certificate No. **T818833N-01-TEC** issued by the Notified Body 0682 can be used for the OEM end product conformity assessment. If a Notified Body has been contracted for the end product conformity assessment, it should be noted that this EU Type Examination Certificate should be used for conformance assessment.

As a result of the conformity assessment procedure described in 2014/53/EU Directive, the end customer equipment should be labelled as follows:



The requirements for CE marking are described in regulation (EC) No. 765/2008 Annex II.



The end customer has to assure that the device has a distance of more than 5 mm from the human body under all circumstances.

If the end customer application intends to use the PAN1781 in a distance smaller 5 mm from the human body, SAR evaluation has to be repeated by the OEM.

The end customer equipment must meet the actual Safety/Health requirements according to RED.

PAN1781 and its model versions in the specified reference design can be used in all countries of the European Economic Area (Member States of the EU, European Free Trade Association States [Iceland, Liechtenstein, Norway]), Monaco, San Marino, Andorra, and Turkey.

6.5 Bluetooth

The final Bluetooth end product listing needs to be created by using the following IDs:

Bluetooth 5	Declaration ID	QDID
End Product (PAN1781 Bluetooth LE LR Module)	D054152	164160

Bluetooth Marks

According to the Bluetooth SIG, the PAN1781 fulfills the criteria to label your product as a Bluetooth device:



For further information please refer to the Bluetooth website www.bluetooth.com.

6.6 RoHS and REACH Declaration

The latest declaration of environmental compatibility (Restriction of Hazardous Substances, RoHS and Registration, Evaluation, Authorisation and Restriction of Chemicals, REACH) for supplied products can be found on the Panasonic website in the “Downloads” section of the respective product ⇒ [7.2.2 Product Information](#).

7 Appendix

7.1 Ordering Information

Variants and Versions

Order Number	Brand Name	Description	MOQ ¹
ENW89857A1KF ²	PAN1781	Bluetooth Low Energy Single Mode with Antenna Empty Flash	1 500

¹ Abbreviation for Minimum Order Quantity (MOQ). The default MOQ for mass production is 1 500 pieces, fewer only on customer demand. Samples for evaluation can be delivered at any quantity via the distribution channels.

² Samples are available on customer demand.

7.2 Contact Details

7.2.1 Contact Us

Please contact your local Panasonic Sales office for details on additional product options and services:

For Panasonic Sales assistance in the **EU**, visit

<https://eu.industrial.panasonic.com/about-us/contact-us>

Email: wireless@eu.panasonic.com

For Panasonic Sales assistance in **North America**, visit the Panasonic website “Sales & Support” to find assistance near you at

<https://na.industrial.panasonic.com/distributors>

Please visit the **Panasonic Wireless Technical Forum** to submit a question at

<https://forum.na.industrial.panasonic.com>

7.2.2 Product Information

Please refer to the Panasonic Wireless Connectivity website for further information on our products and related documents:

For complete Panasonic product details in the **EU**, visit

<http://pideu.panasonic.de/products/wireless-modules.html>

For complete Panasonic product details in **North America**, visit

<http://www.panasonic.com/rfmodules>