

GlobTek, Inc. www.globtek.com 186 Veterans Drive, Northvale, NJ 07647 Tel. (201) 784-1000 Fax (201) 784-0111	Drawing Title: GTM96605-G2A1-R3A(PPS), USB Power Delivery (PD) Source, ICT/ITE/Medical, Efficiency Level: USA DOE Level VI / Eco-design Directive 2009/125/EC, (EU) 2019/1782, Case Color/Style: GlobTek Black, Wall Plug-in+Desktop Combination, USB Adaptive Power Supply AC Adaptor, Input Rating: 100-240V~, 50-60Hz, IEC 60320/C6, Output Rating: 60W, 5V, 9V, 15V, 20V, PPS(3.6-11V), PPS(3.6V-16V), PPS(3.6-20V)V@4.6A, 4.4A, 3.6A, 3.0A, 4.0A, 3.5A, 3.0AA, Output Configuration: 1500 mm, 2C 20 + 3C 28/5C + Shield Cond, N/A, USB Type-C Connector, Shielded, Unibody, Rugged, Ferrite: None, GlobTek Black, GT Cord # C51824, Pin Out: +V: A4, A9, B4, B9, GND: A1, A12, B1, B12, CC1: A5, D+:A6, D-:A7, Blades/Input Cord: R-Series Desktop Insert, Approvals: LPS 60950; RCM; EAC; CE; China RoHS; Level VI; PSE; RoHS; VCCI; WEEE; Class I; Ukraine; CB 60601-1 2MOPP (6W max); CB 60950; CB 62368 (pending); CCC; ETL 62368; ETL; cETLus 60601-1 3rd; cETLus 60601; RCM; S-Mark 60950; UKCA; Conforms to 62368-1; Morocco;	
	Model No. GTM96605-G2A1-R3A(PPS)	
	Part No./Ordering No. RR9LZ3000USBCPPS(R6B)	Rev A7

In Addition to GlobTek Inc.'s renewed ISO9001:2015 - Quality Management System Certification, GlobTek Inc. is now certified to:

ISO13485:2016 - Medical Devices Quality Management System Certification

ISO14001:2015 - Environmental Management System Certification

ISO Certificates are available online at <https://www.globtek.com/iso-certificates/>

The acceptance of this specification and use of the product described in this document indicates the acceptance and binding of the customer to Globtek TERMS AND CONDITIONS (attached to the end of this document), which supersede all other agreements, terms, and conditions (<https://en.globtek.com/terms-and-conditions/>).

The purchaser of this product (Customer) agrees that it is their sole responsibility to determine suitability/fitness of the product described in this specification for their application and to take precautions for protection against any hazards attendant to the handling and use of the product.

Footnote:

GlobTek Inc. will not be liable for the safety and performance of these power supplies/battery packs if unauthorized access and repair occurs. End user should consult applicable UL, CSA or EN standards for proper installation instruction.

Limitation of Use:

GlobTek products are intended for use with commercial, medical, and/or industrial equipment only. GlobTek product are not authorized for use as mission critical components in life support hazardous environment, nuclear or aircraft applications without prior written approval from the CEO of GlobTek Inc.

Contents of this document are subject to change without prior notice.

Customer Approval of Specification:

Please approve, sign and send back to GlobTek so we can complete order processing.

A delay in receipt of this form will delay delivery schedule.

Company Name: _____	Customer P/N: _____
Quote Number: _____	Date: _____
Authorized Representative Name: _____	Authorized Representative Signature: _____

GloTek, Inc. www.globtek.com 186 Veterans Drive, Northvale, NJ 07647 Tel. (201) 784-1000 Fax (201) 784-0111	Drawing Title: GTM96605-G2A1-R3A(PPS), USB Power Delivery (PD) Source, ICT/ITE/Medical, Efficiency Level: USA DOE Level VI / Eco-design Directive 2009/125/EC, (EU) 2019/1782, Case Color/Style: GlobTek Black, Wall Plug-in+Desktop Combination, USB Adaptive Power Supply AC Adaptor, Input Rating: 100-240V~, 50-60Hz, IEC 60320/C6, Output Rating: 60W, 5V, 9V, 15V, 20V, PPS(3.6-11V), PPS(3.6V-16V), PPS(3.6-20V)V@4.6A, 4.4A, 3.6A, 3.0A, 4.0A, 3.5A, 3.0AA, Output Configuration: 1500 mm, 2C 20 + 3C 28/5C + Shield Cond, N/A, USB Type-C Connector, Shielded, Unibody, Rugged, Ferrite: None, GlobTek Black, GT Cord # C51824, Pin Out: +V: A4, A9, B4, B9, GND: A1, A12, B1, B12, CC1: A5, D+:A6, D-:A7, Blades/Input Cord: R-Series Desktop Insert, Approvals: LPS 60950; RCM; EAC; CE; China RoHS; Level VI; PSE; RoHS; VCCI; WEEE; Class I; Ukraine; CB 60601-1 2MOPP (6W max); CB 60950; CB 62368 (pending); CCC; ETL 62368; ETL; cETLus 60601-1 3rd; cETLus 60601; RCM; S-Mark 60950; UKCA; Conforms to 62368-1; Morocco;	
	Model No. GTM96605-G2A1-R3A(PPS)	
	Part No./Ordering No. RR9LZ3000USBCPPS(R6B)	Rev A7

REVISION HISTORY

REV	DESCRIPTION	SUB	DATE	APPROVED
A7	Update firmware version from GTF-BAAC-2 to GTF-D336-2	QA	06/21/2022	QA
A6	Change Firmware from GTF-B361-2 to GTF-BAAC-2	QA	08/27/2021	QA
A5	Update 'CCC' approval from Altitude up to 2000 m to Altitude up to 5000 m	QA	09/30/2020	QA
A4	Update firmware, add PPS(3.6-16V) and PPS(3.6-20V), remove 5.8V and 12V	QA	09/21/2020	QA
A3	Update Firmware	QA	09/21/2020	QA
A2	UPDATE FIRMWARE	DR	05/25/2020	QA
A1	Update firmware	DR	05/20/2020	QA
A	Initial release	krakoM	01/30/2020	QA

POWER SUPPLY INFORMATION

TYPE	Wall Plug-in+Desktop Combination
TECHNOLOGY	USB Adaptive Power Supply AC Adaptor
FIRMWARE VER	GTF-D336-2
CASE COLOR	GlobTek Black
NAMEPLATE RATED INPUT	100-240V~, 50-60Hz, 1.5A
INPUT CONFIG	IEC 60320/C6
WATTS	60.00
VOLTS OUT	5V, 9V, 15V, 20V, PPS(3.6-11V), PPS(3.6V-16V), PPS(3.6-20V)
CURRENT OUT (Amps)	4.6A, 4.4A, 3.6A, 3.0A, 4.0A, 3.5A, 3.0A
BLADE/CORD INCLUDED	R-DI R-Series Desktop Insert
BLADE/CORD INSTALLED	R-DI :R-Series Desktop Insert
INGRESS PROTECTION	
GROUNDING CONFIGURATION	(F2) Isolated Functional Earth for GTM96 series, Improved EMC
EFFICIENCY LEVEL	USA DOE Level VI / Eco-design Directive 2009/125/EC, (EU) 2019/1782
OUTPUT CONFIGURATION	1500 mm, 2C 20 + 3C 28/5C + Shield Cond, N/A, USB Type-C Connector, Shielded, Unibody, Rugged, Ferrite: None, GlobTek Black, GT Cord # C51824
OVERMOLDED	Yes
OUTPUT CONNECTOR GENDER	Male
CONNECTOR PIN OUT	+V: A4, A9, B4, B9, GND: A1, A12, B1, B12, CC1: A5, D+:A6, D-:A7
LABEL SPECS	ISO 15223 medical device compliant label,L-1470
SPECIAL BARCODE LABEL MATERIAL	No
PACK SPEC	Standard DT, Cellular packaging, User manual
USER MANUAL	809-DESKTOPUSERMANUAL on A4 paper

PROPRIETARY INFORMATION

GlobTek, Inc. www.globtek.com 186 Veterans Drive, Northvale, NJ 07647 Tel. (201) 784-1000 Fax (201) 784-0111	Drawing Title: GTM96605-G2A1-R3A(PPS), USB Power Delivery (PD) Source, ICT/ITE/Medical, Efficiency Level: USA DOE Level VI / Eco-design Directive 2009/125/EC, (EU) 2019/1782, Case Color/Style: GlobTek Black, Wall Plug-in+Desktop Combination, USB Adaptive Power Supply AC Adaptor, Input Rating: 100-240V~, 50-60Hz, IEC 60320/C6, Output Rating: 60W, 5V, 9V, 15V, 20V, PPS(3.6-11V), PPS(3.6V-16V), PPS(3.6-20V)V@4.6A, 4.4A, 3.6A, 3.0A, 4.0A, 3.5A, 3.0AA, Output Configuration: 1500 mm, 2C 20 + 3C 28/5C + Shield Cond, N/A, USB Type-C Connector, Shielded, Unibody, Rugged, Ferrite: None, GlobTek Black, GT Cord # C51824, Pin Out: +V: A4, A9, B4, B9, GND: A1, A12, B1, B12, CC1: A5, D+:A6, D-:A7, Blades/Input Cord: R-Series Desktop Insert, Approvals: LPS 60950; RCM; EAC; CE; China RoHS; Level VI; PSE; RoHS; VCCI; WEEE; Class I; Ukraine; CB 60601-1 2MOPP (6W max); CB 60950; CB 62368 (pending); CCC; ETL 62368; ETL; cETLus 60601-1 3rd; cETLus 60601; RCM; S-Mark 60950; UKCA; Conforms to 62368-1; Morocco;	
	Model No. GTM96605-G2A1-R3A(PPS)	
	Part No./Ordering No. RR9LZ3000USBCPPS(R6B)	Rev A7

Notes/Modifications/Customizations (notes in this section supersede the values shown in the standard spec)

DIMENSIONS ARE IN MM UNLESS SPECIFIED OTHERWISE

GlobTek, Inc. www.globtek.com 186 Veterans Drive, Northvale, NJ 07647 Tel. (201) 784-1000 Fax (201) 784-0111	Drawing Title: GTM96605-G2A1-R3A(PPS), USB Power Delivery (PD) Source, ICT/ITE/Medical, Efficiency Level: USA DOE Level VI / Eco-design Directive 2009/125/EC, (EU) 2019/1782, Case Color/Style: GlobTek Black, Wall Plug-in+Desktop Combination, USB Adaptive Power Supply AC Adaptor, Input Rating: 100-240V~, 50-60Hz, IEC 60320/C6, Output Rating: 60W, 5V, 9V, 15V, 20V, PPS(3.6-11V), PPS(3.6V-16V), PPS(3.6-20V)V@4.6A, 4.4A, 3.6A, 3.0A, 4.0A, 3.5A, 3.0AA, Output Configuration: 1500 mm, 2C 20 + 3C 28/5C + Shield Cond, N/A, USB Type-C Connector, Shielded, Unibody, Rugged, Ferrite: None, GlobTek Black, GT Cord # C51824, Pin Out: +V: A4, A9, B4, B9, GND: A1, A12, B1, B12, CC1: A5, D+:A6, D-:A7, Blades/Input Cord: R-Series Desktop Insert, Approvals: LPS 60950; RCM; EAC; CE; China RoHS; Level VI; PSE; RoHS; VCCI; WEEE; Class I; Ukraine; CB 60601-1 2MOPP (6W max); CB 60950; CB 62368 (pending); CCC; ETL 62368; ETL; cETLus 60601-1 3rd; cETLus 60601; RCM; S-Mark 60950; UKCA; Conforms to 62368-1; Morocco;	
	Model No. GTM96605-G2A1-R3A(PPS)	
	Part No./Ordering No. RR9LZ3000USBCPPS(R6B)	Rev A7

ELECTRICAL SPECIFICATIONS

USB Power Delivery Capabilities

Protocols supported:	USB Power Delivery (PD) 2.0/3.0 + PPS
Default Output State:	5V/2.0A
Advertised Power Data Objects (PDOs):	Standard option: 5V, 5.8V, 9V, 12V, 15V, 15.1V [†] , 20V PPS option: 5V, 9V, 15V, 20V, PPS (3.6-11V), PPS (3.6-16V), PPS (3.6-20V) Refer to the 'Rating Table' for output current capability for each USB PD PDO.
Output Current:	Models with -RA suffix have a female USB Type-C connector for use with a detachable USB Type-C cable. If no E-marked cable is detected, the maximum current is limited to 3A. Models without a suffix have a captive 5A rated cable and can always deliver the full current per the 'Rating Table'.
Note 1:	Custom fixed PDOs available upon request. PDO1 must be 5V. PDO2 through PDO7 may be set to any custom voltage from 3.6V to 20V, with a step size of 100mV.
Note 2:	In critical applications, the use of a non-authorized USB PD power adapter may pose a substantial risk. The power adapter's identity may be checked and validated prior to PD contract negotiation by using USB PD Vendor Defined Messages (VDMs). Please see our article Product Security and Risk Mitigation for USB Power Delivery (PD) Based Systems for additional information.

Qualcomm Quick Charge™ Capabilities

Protocols supported:	Quick Charge™ 2.0/3.0		
Default Output State:	5V/2.0A		
HVDCP Class B Profiles:	D+	D-	Output
	0.6V	GND	5.0V/4.6A
	3.3V	0.6V	9.0V/4.4A
	0.6V	0.6V	12V/4.0A
	3.3V	3.3V	20V/3.0A
	0.6V	3.3V	Continuous mode. Adjust from 3.6V to 20V in 200mV steps.
Output Current:	Models with -RA suffix are limited to 3A, as Quick Charge does not support USB PD E-marked cables. Models without a suffix can deliver full rated Quick Charge current.		

Input

Specified: 90-264VAC, Nameplate: 100-240VAC
100% rated load current for 90-264VAC

GlobTek, Inc. www.globtek.com 186 Veterans Drive, Northvale, NJ 07647 Tel. (201) 784-1000 Fax (201) 784-0111	Drawing Title: GTM96605-G2A1-R3A(PPS), USB Power Delivery (PD) Source, ICT/ITE/Medical, Efficiency Level: USA DOE Level VI / Eco-design Directive 2009/125/EC, (EU) 2019/1782, Case Color/Style: GlobTek Black, Wall Plug-in+Desktop Combination, USB Adaptive Power Supply AC Adaptor, Input Rating: 100-240V~, 50-60Hz, IEC 60320/C6, Output Rating: 60W, 5V, 9V, 15V, 20V, PPS(3.6-11V), PPS(3.6V-16V), PPS(3.6-20V)V@4.6A, 4.4A, 3.6A, 3.0A, 4.0A, 3.5A, 3.0AA, Output Configuration: 1500 mm, 2C 20 + 3C 28/5C + Shield Cond, N/A, USB Type-C Connector, Shielded, Unibody, Rugged, Ferrite: None, GlobTek Black, GT Cord # C51824, Pin Out: +V: A4, A9, B4, B9, GND: A1, A12, B1, B12, CC1: A5, D+:A6, D-:A7, Blades/Input Cord: R-Series Desktop Insert, Approvals: LPS 60950; RCM; EAC; CE; China RoHS; Level VI; PSE; RoHS; VCCI; WEEE; Class I; Ukraine; CB 60601-1 2MOPP (6W max); CB 60950; CB 62368 (pending); CCC; ETL 62368; ETL; cETLus 60601-1 3rd; cETLus 60601; RCM; S-Mark 60950; UKCA; Conforms to 62368-1; Morocco;	
	Model No. GTM96605-G2A1-R3A(PPS)	
	Part No./Ordering No. RR9LZ3000USBCPPS(R6B)	Rev A7

Input Voltage:	85% rated load current for 85-264VAC 100% rated load current for 110-370VDC
Input Frequency:	Specified: 47-63Hz, Nameplate: 50-60Hz
No Load Input Power:	< 75mW @ 230VAC (EU CoC Tier 2 compliant)
Inrush Current:	< 30A @ 115VAC, < 60A @ 230VAC (cold start)
Efficiency:	DoE Efficiency Level VI and CoC Tier 2 compliant (tested according to DoE 10 CFR Part 430, Subpart B, Appendix Z)

Output

Turn-on Delay:	< 1 second (full load, 115VAC)
Output Regulation	± 4% max. (measured at the end of output cord)
Line Regulation:	± 0.5% typ. (measured at the end of output cord)
Ripple:	100mV max. (using a 47µF low-ESR electrolytic cap + 0.1µF ceramic cap, measured @ 20MHz BW, at the output connector)
Transient Response:	5% max. deviation, 1ms max. recovery time (with 40 to 70% load step),
Hold-up Time:	8ms typ. (full load, nominal line voltage)
Power Indicator:	Green LED

Protections

Input Protection:	MOV transient suppressor, input line fusing
Over-Voltage Protection:	Level 1: 110-130%, Auto-recovery, adaptive to selected PDO/QC profile Level 2: 25V (max), Latched off, cycle AC to reset
Over-Current Protection:	110-140%, Auto-recovery, adaptive to selected PDO/QC profile
Short-Circuit Protection:	Auto-recovery
Over-Temperature Protection:	Auto-recovery

Environmental

MTBF:	1,500,000 hours @ 25°C ambient, full load (Telcordia SR-332, Issue 3)
Operating Temperature:	-10°C to 40°C (full load) -10°C to 50°C (80% load)
Storage Temperature:	-30°C to 80°C
Humidity:	0% to 95% relative humidity, non-condensing
Altitude	5000m
Cooling:	Convection
RoHS:	Complies with EU 2011/65/EU and China SJ/T 11363-2006

Safety

Dielectric Withstand Voltage:	4000VAC or 5656VDC from input to output
-------------------------------	-----------------------------------------

GlobTek, Inc. www.globtek.com 186 Veterans Drive, Northvale, NJ 07647 Tel. (201) 784-1000 Fax (201) 784-0111	Drawing Title: GTM96605-G2A1-R3A(PPS), USB Power Delivery (PD) Source, ICT/ITE/Medical, Efficiency Level: USA DOE Level VI / Eco-design Directive 2009/125/EC, (EU) 2019/1782, Case Color/Style: GlobTek Black, Wall Plug-in+Desktop Combination, USB Adaptive Power Supply AC Adaptor, Input Rating: 100-240V~, 50-60Hz, IEC 60320/C6, Output Rating: 60W, 5V, 9V, 15V, 20V, PPS(3.6-11V), PPS(3.6V-16V), PPS(3.6-20V)V@4.6A, 4.4A, 3.6A, 3.0A, 4.0A, 3.5A, 3.0AA, Output Configuration: 1500 mm, 2C 20 + 3C 28/5C + Shield Cond, N/A, USB Type-C Connector, Shielded, Unibody, Rugged, Ferrite: None, GlobTek Black, GT Cord # C51824, Pin Out: +V: A4, A9, B4, B9, GND: A1, A12, B1, B12, CC1: A5, D+:A6, D-:A7, Blades/Input Cord: R-Series Desktop Insert, Approvals: LPS 60950; RCM; EAC; CE; China RoHS; Level VI; PSE; RoHS; VCCI; WEEE; Class I; Ukraine; CB 60601-1 2MOPP (6W max); CB 60950; CB 62368 (pending); CCC; ETL 62368; ETL; cETLus 60601-1 3rd; cETLus 60601; RCM; S-Mark 60950; UKCA; Conforms to 62368-1; Morocco;	
	Model No. GTM96605-G2A1-R3A(PPS)	
	Part No./Ordering No. RR9LZ3000USBCPPS(R6B)	Rev A7

Touch Current:	3-conductor models: 20µA max. 2-conductor models: 65µA max.
Earth Leakage Current	300µA max. NC/SFC (N/A for 2-conductor input models)
Means of Protection:	2 x MOPP
Output Isolation Options:	-T2/R2 suffix: Class II 2-conductor (C8/C18 inlet or interchangeable blades) -T3/R3 suffix: Class II, with functional earth (FE) (C6/C14 inlet or interchangeable blades) Class I, earth wire connected directly to output negative (C6/C14 inlet or interchangeable blades)
Note 3:	Review output isolation options with our article: PSU Isolation and Identify

EMC

Applicable Standards:	Medical: EN 60601-1-2 (4e) Emissions: EN55032, EN61000-6-3, EN61000-6-4 Immunity: EN55024, EN61000-6-1 (4e), EN61000-6-2 (4e)
Conducted Emissions:	Class B, FCC Part 15, Class B (with resistive load)
Radiated Emissions:	Class B, FCC Part 15, Class B (with resistive load)
Harmonic Current Voltage Distortion:	EN61000-3-2, Class A
Voltage Fluctuations/Flicker:	EN61000-3-3
Electrostatic Discharge (ESD) Immunity:	EN61000-4-2, 10KV contact discharge, 18KV air discharge, Criterion A
Radiated RF Immunity:	EN61000-4-3, 10V/m @ 80-1000MHz, 3V/m @ 1-2.7GHz, 80% 1KHz AM, Criterion A
EFT/Burst Immunity:	EN61000-4-4, 2KV/100KHz., Criterion A; 4KV/100KHz, Criterion B
Line Surge Immunity:	EN61000-4-5, 2KV differential, 2KV common-mode, Criterion A; 4KV common-mode, Criterion B
Conducted RF Immunity:	EN61000-4-6, 3VRMS, 80% 1KHz AM, Criterion A
Power Frequency Magnetic Field Immunity:	EN61000-4-8, 30A/m, Criterion A
Voltage Dip Immunity:	EN61000-4-11, Criterion B

Enclosure

Housing:	High impact plastic, 94V0 polycarbonate, non-vented Desktop T2/T3: C6, C8, C14, or C18 IEC inlet Hybrid (desktop or wall plug-in): Class I or Class II input
Markings:	No suffix: Captive 1.5m shielded USB Type-C cable -RA suffix: Female USB Type-C connector integrated into housing Adhesive backed label or laser engraving

Prevention of Unauthorized Use

In critical applications, the use of a non-authorized USB PD power adapter may pose a substantial risk to system safety or performance.

The power adapter's identity may be checked and validated prior to PD contract negotiation by use

GlobTek, Inc. www.globtek.com 186 Veterans Drive, Northvale, NJ 07647 Tel. (201) 784-1000 Fax (201) 784-0111	Drawing Title: GTM96605-G2A1-R3A(PPS), USB Power Delivery (PD) Source, ICT/ITE/Medical, Efficiency Level: USA DOE Level VI / Eco-design Directive 2009/125/EC, (EU) 2019/1782, Case Color/Style: GlobTek Black, Wall Plug-in+Desktop Combination, USB Adaptive Power Supply AC Adaptor, Input Rating: 100-240V~, 50-60Hz, IEC 60320/C6, Output Rating: 60W, 5V, 9V, 15V, 20V, PPS(3.6-11V), PPS(3.6V-16V), PPS(3.6-20V)V@4.6A, 4.4A, 3.6A, 3.0A, 4.0A, 3.5A, 3.0AA, Output Configuration: 1500 mm, 2C 20 + 3C 28/5C + Shield Cond, N/A, USB Type-C Connector, Shielded, Unibody, Rugged, Ferrite: None, GlobTek Black, GT Cord # C51824, Pin Out: +V: A4, A9, B4, B9, GND: A1, A12, B1, B12, CC1: A5, D+:A6, D-:A7, Blades/Input Cord: R-Series Desktop Insert, Approvals: LPS 60950; RCM; EAC; CE; China RoHS; Level VI; PSE; RoHS; VCCI; WEEE; Class I; Ukraine; CB 60601-1 2MOPP (6W max); CB 60950; CB 62368 (pending); CCC; ETL 62368; ETL; cETLus 60601-1 3rd; cETLus 60601; RCM; S-Mark 60950; UKCA; Conforms to 62368-1; Morocco;	
	Model No. GTM96605-G2A1-R3A(PPS)	
	Part No./Ordering No. RR9LZ3000USBCPPS(R6B)	Rev A7

USB Power Delivery:	of USB PD Vendor Defined Messages (VDMs). The power adapter will respond to a USB PD "Discover Identity" VDM with 0x4754 in the "ProductID" field. Additionally, non-standard 5.8V and 15.1V PDOs are included. Host systems may be designed to reject a power adapter which does not contain one of these PDOs.
Note 4:	These measures do not guarantee a secure implementation, and are only suggested as a method of risk mitigation.
Note 5:	Please see our article Product Security and Risk Mitigation for USB Power Delivery (PD) Based Systems for additional information.

Special Options

Non-standard - Contact GlobTek

1. Custom housing and output cord colors
2. Custom fixed output cord length, for applicable models (1m, 2m, 3m lengths,etc.)
3. Custom markings and marking methods
4. Custom USB PD PDOs: Output voltages selectable between 5V and 20V, in 100mV increments
5. USB Micro-B connector for Quick Charge™-only applications
6. Quick Charge™ 4.0/4.0+ support

† 15.1V PDO is standard on units with date codes after Sept-10-2019.

†† VDM functionality is standard on units with date codes after Sept-10-2019.

TO ADDRESS SYSTEM-LEVEL EMI CONCERNS, FERRITE CHOKES/BEADS MAY BE ADDED/REVISED UPON REQUEST. A SAMPLE KIT OF GLOBTEK'S STANDARD FERRITES IS AVAILABLE UNDER GLOBTEK P/N: EMI-MITIGATION-KIT1

FOR ADDITIONAL INFORMATION, PLEASE READ OUR WHITE PAPER AT: <https://r.globtek.info/3QeaqtD>

GlobTek, Inc.
 www.globtek.com
 186 Veterans Drive,
 Northvale, NJ 07647
 Tel. (201) 784-1000
 Fax (201) 784-0111

Drawing Title: GTM96605-G2A1-R3A(PPS), USB Power Delivery (PD) Source, ICT/ITE/Medical, Efficiency Level: USA DOE Level VI / Eco-design Directive 2009/125/EC, (EU) 2019/1782, Case Color/Style: GlobTek Black, Wall Plug-in+Desktop Combination, USB Adaptive Power Supply AC Adaptor, Input Rating: 100-240V~, 50-60Hz, IEC 60320/C6, Output Rating: 60W, 5V, 9V, 15V, 20V, PPS(3.6-11V), PPS(3.6V-16V), PPS(3.6-20V)V@4.6A, 4.4A, 3.6A, 3.0A, 4.0A, 3.5A, 3.0AA, Output Configuration: 1500 mm, 2C 20 + 3C 28/5C + Shield Cond, N/A, USB Type-C Connector, Shielded, Unibody, Rugged, Ferrite: None, GlobTek Black, GT Cord # C51824, Pin Out: +V: A4, A9, B4, B9, GND: A1, A12, B1, B12, CC1: A5, D+:A6, D-:A7, Blades/Input Cord: R-Series Desktop Insert, Approvals: LPS 60950; RCM; EAC; CE; China RoHS; Level VI; PSE; RoHS; VCCI; WEEE; Class I; Ukraine; CB 60601-1 2MOPP (6W max); CB 60950; CB 62368 (pending); CCC; ETL 62368; ETL; cETLus 60601-1 3rd; cETLus 60601; RCM; S-Mark 60950; UKCA; Conforms to 62368-1; Morocco;

Model No. GTM96605-G2A1-R3A(PPS)

Part No./Ordering No. RR9LZ3000USBCPPS(R6B)

Rev A7

3D File Download <https://www.globtek.com/dl/GTM96605-R3.igs>

Mechanical drawing

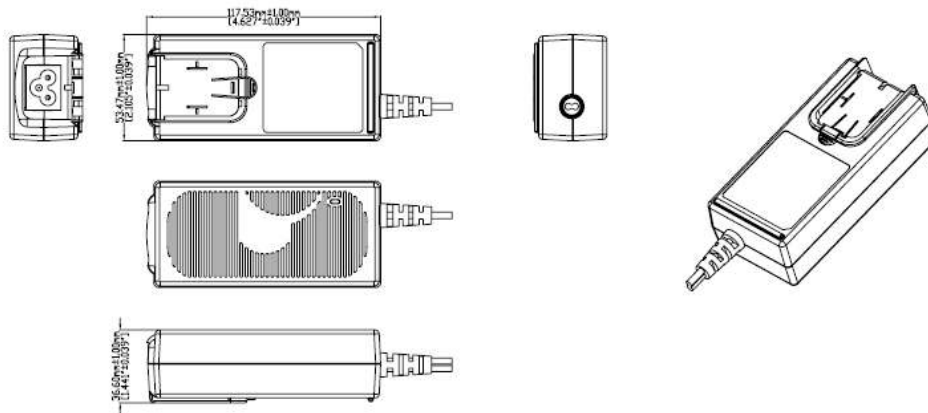

Drawing above is model with output cord

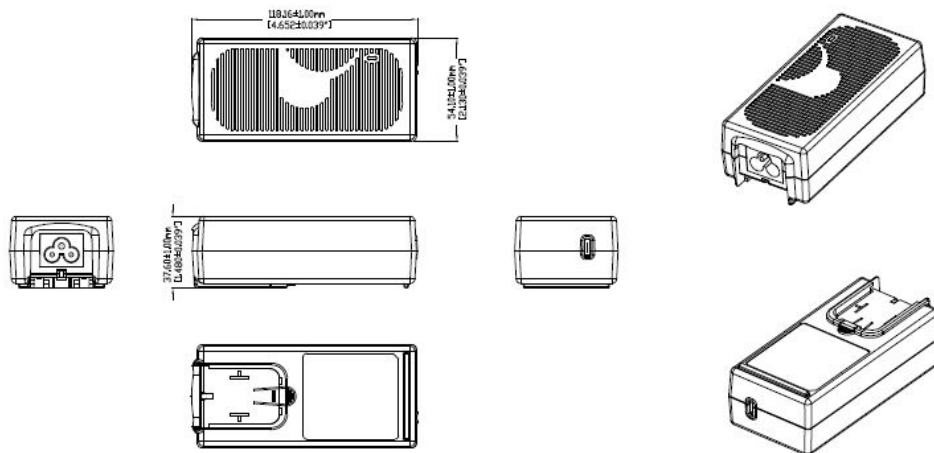

Drawing above is model with integrated USB-C connector (suffix -RA)

<p>GlobTek, Inc. www.globtek.com 186 Veterans Drive, Northvale, NJ 07647 Tel. (201) 784-1000 Fax (201) 784-0111</p>	<p>Drawing Title: GTM96605-G2A1-R3A(PPS), USB Power Delivery (PD) Source, ICT/ITE/Medical, Efficiency Level: USA DOE Level VI / Eco-design Directive 2009/125/EC, (EU) 2019/1782, Case Color/Style: GlobTek Black, Wall Plug-in+Desktop Combination, USB Adaptive Power Supply AC Adaptor, Input Rating: 100-240V~, 50-60Hz, IEC 60320/C6, Output Rating: 60W, 5V, 9V, 15V, 20V, PPS(3.6-11V), PPS(3.6V-16V), PPS(3.6-20V)V@4.6A, 4.4A, 3.6A, 3.0A, 4.0A, 3.5A, 3.0AA, Output Configuration: 1500 mm, 2C 20 + 3C 28/5C + Shield Cond, N/A, USB Type-C Connector, Shielded, Unibody, Rugged, Ferrite: None, GlobTek Black, GT Cord # C51824, Pin Out: +V: A4, A9, B4, B9, GND: A1, A12, B1, B12, CC1: A5, D+:A6, D-:A7, Blades/Input Cord: R-Series Desktop Insert, Approvals: LPS 60950; RCM; EAC; CE; China RoHS; Level VI; PSE; RoHS; VCCI; WEEE; Class I; Ukraine; CB 60601-1 2MOPP (6W max); CB 60950; CB 62368 (pending); CCC; ETL 62368; ETL; cETLus 60601-1 3rd; cETLus 60601; RCM; S-Mark 60950; UKCA; Conforms to 62368-1; Morocco;</p>
	<p>Model No. GTM96605-G2A1-R3A(PPS)</p>
	<p>Part No./Ordering No. RR9LZ3000USBCPPS(R6B) Rev A7</p>

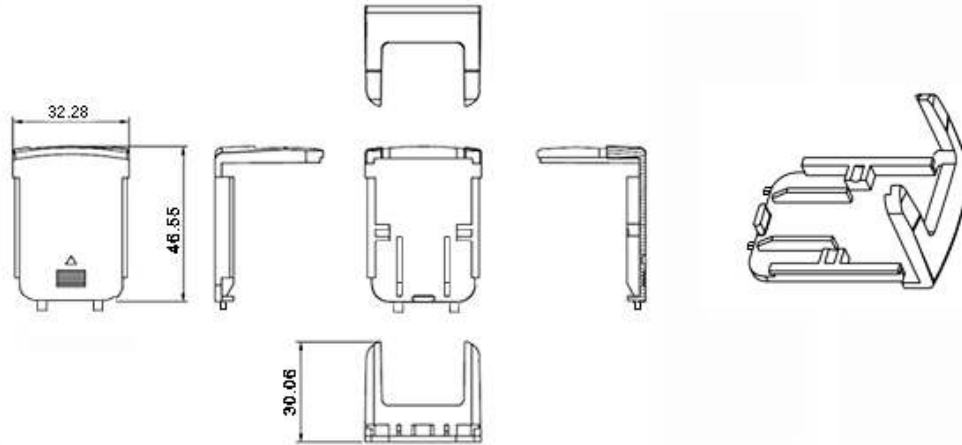

Unit shipped without an installed input plug.
"Desktop insert" installed.

<p>GlobTek, Inc. www.globtek.com 186 Veterans Drive, Northvale, NJ 07647 Tel. (201) 784-1000 Fax (201) 784-0111</p>	<p>Drawing Title: GTM96605-G2A1-R3A(PPS), USB Power Delivery (PD) Source, ICT/ITE/Medical, Efficiency Level: USA DOE Level VI / Eco-design Directive 2009/125/EC, (EU) 2019/1782, Case Color/Style: GlobTek Black, Wall Plug-in+Desktop Combination, USB Adaptive Power Supply AC Adaptor, Input Rating: 100-240V~, 50-60Hz, IEC 60320/C6, Output Rating: 60W, 5V, 9V, 15V, 20V, PPS(3.6-11V), PPS(3.6V-16V), PPS(3.6-20V)V@4.6A, 4.4A, 3.6A, 3.0A, 4.0A, 3.5A, 3.0AA, Output Configuration: 1500 mm, 2C 20 + 3C 28/5C + Shield Cond, N/A, USB Type-C Connector, Shielded, Unibody, Rugged, Ferrite: None, GlobTek Black, GT Cord # C51824, Pin Out: +V: A4, A9, B4, B9, GND: A1, A12, B1, B12, CC1: A5, D+:A6, D-:A7, Blades/Input Cord: R-Series Desktop Insert, Approvals: LPS 60950; RCM; EAC; CE; China RoHS; Level VI; PSE; RoHS; VCCI; WEEE; Class I; Ukraine; CB 60601-1 2MOPP (6W max); CB 60950; CB 62368 (pending); CCC; ETL 62368; ETL; cETLus 60601-1 3rd; cETLus 60601; RCM; S-Mark 60950; UKCA; Conforms to 62368-1; Morocco;</p>
	<p>Model No. GTM96605-G2A1-R3A(PPS)</p>
	<p>Part No./Ordering No. RR9LZ3000USBCPPS(R6B) Rev A7</p>

DERATING CURVE

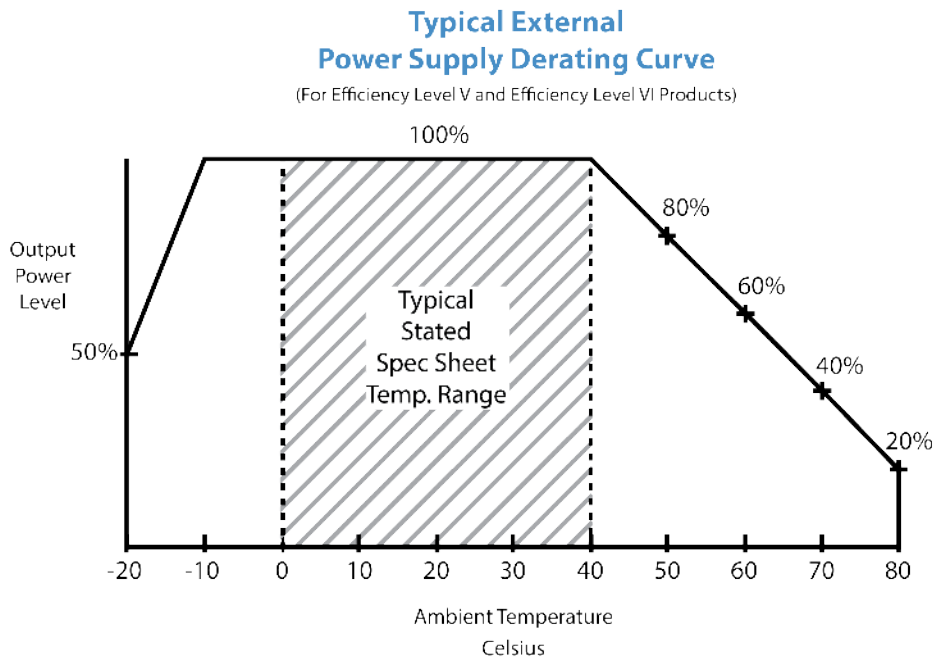

GlobTek, Inc. www.globtek.com 186 Veterans Drive, Northvale, NJ 07647 Tel. (201) 784-1000 Fax (201) 784-0111	Drawing Title: GTM96605-G2A1-R3A(PPS), USB Power Delivery (PD) Source, ICT/ITE/Medical, Efficiency Level: USA DOE Level VI / Eco-design Directive 2009/125/EC, (EU) 2019/1782, Case Color/Style: GlobTek Black, Wall Plug-in+Desktop Combination, USB Adaptive Power Supply AC Adaptor, Input Rating: 100-240V~, 50-60Hz, IEC 60320/C6, Output Rating: 60W, 5V, 9V, 15V, 20V, PPS(3.6-11V), PPS(3.6V-16V), PPS(3.6-20V)V@4.6A, 4.4A, 3.6A, 3.0A, 4.0A, 3.5A, 3.0AA, Output Configuration: 1500 mm, 2C 20 + 3C 28/5C + Shield Cond, N/A, USB Type-C Connector, Shielded, Unibody, Rugged, Ferrite: None, GlobTek Black, GT Cord # C51824, Pin Out: +V: A4, A9, B4, B9, GND: A1, A12, B1, B12, CC1: A5, D+:A6, D-:A7, Blades/Input Cord: R-Series Desktop Insert, Approvals: LPS 60950; RCM; EAC; CE; China RoHS; Level VI; PSE; RoHS; VCCI; WEEE; Class I; Ukraine; CB 60601-1 2MOPP (6W max); CB 60950; CB 62368 (pending); CCC; ETL 62368; ETL; cETLus 60601-1 3rd; cETLus 60601; RCM; S-Mark 60950; UKCA; Conforms to 62368-1; Morocco;	
	Model No. GTM96605-G2A1-R3A(PPS)	
	Part No./Ordering No. RR9LZ3000USBCPPS(R6B)	Rev A7

INPUT CONFIGURATION

(F2) Isolated Functional Earth for GTM96 series, Improved EMC

GTM96XXX Optional Config

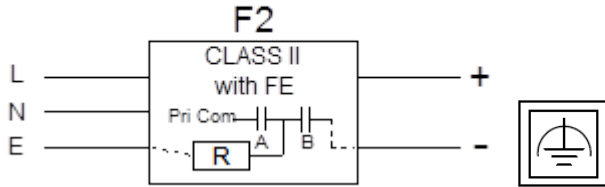

[Alternate grounding configurations](#) available upon request.

Blades/Cord Included:R-DI:R-Series Desktop Insert

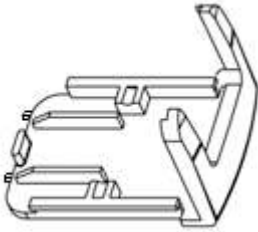

Desktop Insert Installed

Blades/Cord Installed:R-DI:R-Series Desktop Insert

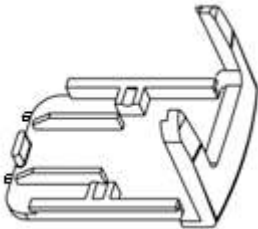

Desktop Insert Installed

IEC 60320/C6 AC Inlet Connector, Class I, Earth Ground (aka "Mickey Mouse")

PROPRIETARY INFORMATION

GlobTek, Inc. www.globtek.com 186 Veterans Drive, Northvale, NJ 07647 Tel. (201) 784-1000 Fax (201) 784-0111	Drawing Title: GTM96605-G2A1-R3A(PPS), USB Power Delivery (PD) Source, ICT/ITE/Medical, Efficiency Level: USA DOE Level VI / Eco-design Directive 2009/125/EC, (EU) 2019/1782, Case Color/Style: GlobTek Black, Wall Plug-in+Desktop Combination, USB Adaptive Power Supply AC Adaptor, Input Rating: 100-240V~, 50-60Hz, IEC 60320/C6, Output Rating: 60W, 5V, 9V, 15V, 20V, PPS(3.6-11V), PPS(3.6V-16V), PPS(3.6-20V)V@4.6A, 4.4A, 3.6A, 3.0A, 4.0A, 3.5A, 3.0AA, Output Configuration: 1500 mm, 2C 20 + 3C 28/5C + Shield Cond, N/A, USB Type-C Connector, Shielded, Unibody, Rugged, Ferrite: None, GlobTek Black, GT Cord # C51824, Pin Out: +V: A4, A9, B4, B9, GND: A1, A12, B1, B12, CC1: A5, D+:A6, D-:A7, Blades/Input Cord: R-Series Desktop Insert, Approvals: LPS 60950; RCM; EAC; CE; China RoHS; Level VI; PSE; RoHS; VCCI; WEEE; Class I; Ukraine; CB 60601-1 2MOPP (6W max); CB 60950; CB 62368 (pending); CCC; ETL 62368; ETL; cETLus 60601-1 3rd; cETLus 60601; RCM; S-Mark 60950; UKCA; Conforms to 62368-1; Morocco;	
	Model No. GTM96605-G2A1-R3A(PPS)	
	Part No./Ordering No. RR9LZ3000USBCPPS(R6B)	Rev A7

[Blade Insertion Instructions](#)
[R-Blade Style Instruction Video](#)

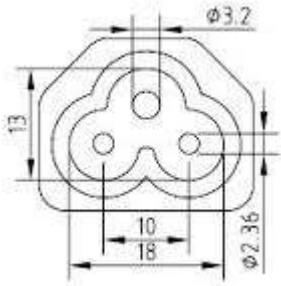

Mates with IEC 60320/C5 Plug

This series of Interchangeable Blade products may be used with Proprietary Interchangeable Blades as described below or with standard international power cords.

Optional INPUT BLADES: R-Socket: below are available blades configurations which are "not included" (unless stated above); may be purchased separately, packaged with power supply, or as a separate "R-KIT" if specified

1. Class I model NEMA 5-15P (Type B), Class I AC power plug with 2 blades & ground pin, R-NA-3(R)
2. Australian AS 3112 (Type I) configuration: SAA 3 pins Class I, R-SAA-3(R)
3. UK BS 1363 (Type G) configuration: UK 3 pins (Ground) Class I, R-UK-3(R)
4. European CEE 7/7 (Type E and F) configuration: European plug 2 PINS + ground, Class I, R-EU-3(R)
5. Desktop Insert
- Kits
05. R-KIT-3(R) 1,2,3,4 above
06. R-KIT-3-INTL(R): 2,3,4 above

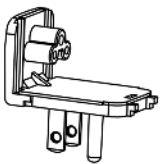

UL 3P

P/N: R-NA-3(R)
 NORTH AMERICA
 JAPAN

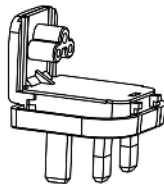

UK 3P

P/N: R-UK-3(R)
 UNITED KINGDOM
 HONG KONG
 SINGAPORE

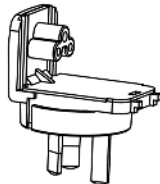

AUS 3P

P/N: R-SAA-3(R)
 AUSTRALIA

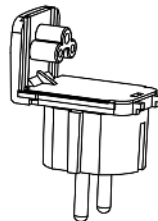

EU 3P

P/N: R-EU-3(R)
 EUROPE
 SOUTH AMERICA

Below are standard cordsets which are "not included" (unless stated above); these can be purchased separately or package with the power supply. Contact your Sales Engineer if the style required is not shown below. Many more available in different lengths, colors or cable material.

[Standard International IEC 320/C5 Cordsets](#)

GloTek, Inc. www.globtek.com 186 Veterans Drive, Northvale, NJ 07647 Tel. (201) 784-1000 Fax (201) 784-0111	Drawing Title: GTM96605-G2A1-R3A(PPS), USB Power Delivery (PD) Source, ICT/ITE/Medical, Efficiency Level: USA DOE Level VI / Eco-design Directive 2009/125/EC, (EU) 2019/1782, Case Color/Style: GlobTek Black, Wall Plug-in+Desktop Combination, USB Adaptive Power Supply AC Adaptor, Input Rating: 100-240V~, 50-60Hz, IEC 60320/C6, Output Rating: 60W, 5V, 9V, 15V, 20V, PPS(3.6-11V), PPS(3.6V-16V), PPS(3.6-20V)V@4.6A, 4.4A, 3.6A, 3.0A, 4.0A, 3.5A, 3.0AA, Output Configuration: 1500 mm, 2C 20 + 3C 28/5C + Shield Cond, N/A, USB Type-C Connector, Shielded, Unibody, Rugged, Ferrite: None, GlobTek Black, GT Cord # C51824, Pin Out: +V: A4, A9, B4, B9, GND: A1, A12, B1, B12, CC1: A5, D+:A6, D-:A7, Blades/Input Cord: R-Series Desktop Insert, Approvals: LPS 60950; RCM; EAC; CE; China RoHS; Level VI; PSE; RoHS; VCCI; WEEE; Class I; Ukraine; CB 60601-1 2MOPP (6W max); CB 60950; CB 62368 (pending); CCC; ETL 62368; ETL; cETLus 60601-1 3rd; cETLus 60601; RCM; S-Mark 60950; UKCA; Conforms to 62368-1; Morocco;	
	Model No. GTM96605-G2A1-R3A(PPS)	
	Part No./Ordering No. RR9LZ3000USBCPPS(R6B)	Rev A7

Part Number / Link	Country	Plug	Connector	Length (mm)	Length (ft)
3021066F712(R)	N. American (Type B)	NEMA 5-15P	IEC 320/C5	1880	6
1191068F0712(R)	N. American (Type B)	NEMA 5-15P Hospital	IEC 320/C5	2459	8
2194262M0712(R)	Argentina (Type I)	IRAM 2073	IEC320/C5	2050	6.7
2064262M0712(R)	Australian (Type I)	AS3112 / 3 PRONG	IEC 320/C5	2000	6.6
204B4262M0712(R)	Brazil (Type N)	BRAZIL	IEC 320/C5	2000	6.6
6023592M5712(R)	China (Type I)	CCC GR2099	IEC 320/C5	2500	8
23144262M0712(R)	Europe (Type E)	CEE 7/7	IEC 320/C5	2050	6.6
2313K3432M0712(R)	Korea (Type F)	KS C 8305	IEC 320/C5	2000	6.6
205IN4262M0712(R)	India (Type D)	India IS 1293 (also known as IA16A3 or BS546)	IEC320/C5	2000	6.6
377C4262M0712(R)	Israel (Type H)	ISL	IEC320/C5	2050	6.7
23024262M0712(R)	Italy (Type L)	CEI 23-16/VII	IEC 320/C5	2000	6.6
3003316F0712(R)	Japan (Type B)	JIS 8303 / 3 PINS	IEC 320/C5	1830	6
3021066F0712ULPSE(R)	Japan / USA (Type B)	JIS 8303 / 3 PINS + NEMA 5-15P	IEC 320/C5	1830	6
2054262M0712(R)	S. Africa (Type D)	South Africa SABS164-1 (6A type plug)	IEC320/C5	2050	6.7
2084262M0712(R)	S.Africa (Type M)	South Africa SABS164-1 (16A type plug)	IEC 320/C5	2000	6.6
23214262M0712(R)	Switzerland (Type J)	SEV 1011 (EL 203)	IEC 320/C5	2000	6.6
3003316F0712(R)	Taiwan (Type B)	BSMI	IEC 320/C5	2000	6.6
6104262M0712(R)	UK, Hong Kong, Singapore, Gulf States (Type G)	BS1363	IEC 320/C5	2000	6.6

GlobTek, Inc. www.globtek.com 186 Veterans Drive, Northvale, NJ 07647 Tel. (201) 784-1000 Fax (201) 784-0111	Drawing Title: GTM96605-G2A1-R3A(PPS), USB Power Delivery (PD) Source, ICT/ITE/Medical, Efficiency Level: USA DOE Level VI / Eco-design Directive 2009/125/EC, (EU) 2019/1782, Case Color/Style: GlobTek Black, Wall Plug-in+Desktop Combination, USB Adaptive Power Supply AC Adaptor, Input Rating: 100-240V~, 50-60Hz, IEC 60320/C6, Output Rating: 60W, 5V, 9V, 15V, 20V, PPS(3.6-11V), PPS(3.6V-16V), PPS(3.6-20V)V@4.6A, 4.4A, 3.6A, 3.0A, 4.0A, 3.5A, 3.0AA, Output Configuration: 1500 mm, 2C 20 + 3C 28/5C + Shield Cond, N/A, USB Type-C Connector, Shielded, Unibody, Rugged, Ferrite: None, GlobTek Black, GT Cord # C51824, Pin Out: +V: A4, A9, B4, B9, GND: A1, A12, B1, B12, CC1: A5, D+:A6, D-:A7, Blades/Input Cord: R-Series Desktop Insert, Approvals: LPS 60950; RCM; EAC; CE; China RoHS; Level VI; PSE; RoHS; VCCI; WEEE; Class I; Ukraine; CB 60601-1 2MOPP (6W max); CB 60950; CB 62368 (pending); CCC; ETL 62368; ETL; cETLus 60601-1 3rd; cETLus 60601; RCM; S-Mark 60950; UKCA; Conforms to 62368-1; Morocco;	
	Model No. GTM96605-G2A1-R3A(PPS)	
	Part No./Ordering No. RR9LZ3000USBCPPS(R6B)	Rev A7

OUTPUT CORD AND CONNECTOR: USB00016/C51824

ACTUAL CONNECTORS, OVERMOLDS, FERRITES MAY VARY SLIGHTLY FROM THE PICTURE BELOW

CABLE TYPE	N/A
CABLE LENGTH (mm)	1500
CABLE TOLERANCE (mm)	±50
WIRE GAUGE (AWG)	2C 20 + 3C 28
CONDUCTORS	5C + Shield
HANK DIMENSION (mm)	80+/-20
CABLE / CONNECTOR OVERMOLD COLOR	GlobTek Black
FERRITE TYPE AND DIMENSION	None
FERRITE NUMBER OF TURNS (Definition)	N/A
FERRITE DIMENSION FROM STRAIN RELIEF	N/A
FERRITE DIMENSION FROM PLUG	N/A
PLUG TYPE	USB Type-C Connector, Shielded, Unibody, Rugged
OUTPUT CONNECTOR GENDER	Male
OVERMOLDED	Yes
OVER MOLD ORIENTATION	Straight
CONNECTOR PIN OUT	+V: A4, A9, B4, B9, GND: A1, A12, B1, B12, CC1: A5, D+:A6, D-:A7

ADDITIONAL REQUIREMENTS

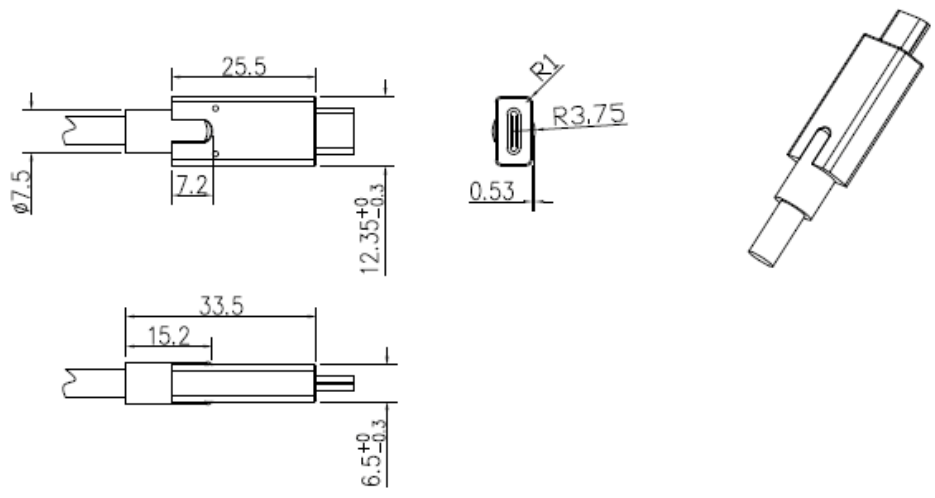

GlobTek, Inc. www.globtek.com 186 Veterans Drive, Northvale, NJ 07647 Tel. (201) 784-1000 Fax (201) 784-0111	Drawing Title: GTM96605-G2A1-R3A(PPS), USB Power Delivery (PD) Source, ICT/ITE/Medical, Efficiency Level: USA DOE Level VI / Eco-design Directive 2009/125/EC, (EU) 2019/1782, Case Color/Style: GlobTek Black, Wall Plug-in+Desktop Combination, USB Adaptive Power Supply AC Adaptor, Input Rating: 100-240V~, 50-60Hz, IEC 60320/C6, Output Rating: 60W, 5V, 9V, 15V, 20V, PPS(3.6-11V), PPS(3.6V-16V), PPS(3.6-20V)V@4.6A, 4.4A, 3.6A, 3.0A, 4.0A, 3.5A, 3.0AA, Output Configuration: 1500 mm, 2C 20 + 3C 28/5C + Shield Cond, N/A, USB Type-C Connector, Shielded, Unibody, Rugged, Ferrite: None, GlobTek Black, GT Cord # C51824, Pin Out: +V: A4, A9, B4, B9, GND: A1, A12, B1, B12, CC1: A5, D+:A6, D-:A7, Blades/Input Cord: R-Series Desktop Insert, Approvals: LPS 60950; RCM; EAC; CE; China RoHS; Level VI; PSE; RoHS; VCCI; WEEE; Class I; Ukraine; CB 60601-1 2MOPP (6W max); CB 60950; CB 62368 (pending); CCC; ETL 62368; ETL; cETLus 60601-1 3rd; cETLus 60601; RCM; S-Mark 60950; UKCA; Conforms to 62368-1; Morocco;	
	Model No. GTM96605-G2A1-R3A(PPS)	
	Part No./Ordering No. RR9LZ3000USBCPPS(R6B)	Rev A7



GlobTek's USB00016 USB Type C connector is:

- Shielded for improved EMI performance
- Unibody plug and PCB cover with integrated cable clamp provide superior ruggedability and prevents breakage as may be seen on simple USB C cables with separate plug and PCB components
- Cable clamp with overmold provides for very high pull force withstand
- More robust in terms of bending protection after plug is insert
- Less component stress during the manufacturing process like first step overmolding
- Superior cosmetic appearance

ADDITIONAL OUTPUT PLUG OPTIONS ARE AVAILABLE AT <https://www.globtek.com/connectors/>

STANDARD PLUGS AND CONNECTORS CAN BE SEEN ONLINE AT <https://www.globtek.com/connectors/>

CALCULATE VOLTAGE REGULATION/DROP WITH OUR ONLINE CALCULATOR: <https://en.globtek.com/output-cable-regulation-calculator/>

GlobTek, Inc. www.globtek.com 186 Veterans Drive, Northvale, NJ 07647 Tel. (201) 784-1000 Fax (201) 784-0111	Drawing Title: GTM96605-G2A1-R3A(PPS), USB Power Delivery (PD) Source, ICT/ITE/Medical, Efficiency Level: USA DOE Level VI / Eco-design Directive 2009/125/EC, (EU) 2019/1782, Case Color/Style: GlobTek Black, Wall Plug-in+Desktop Combination, USB Adaptive Power Supply AC Adaptor, Input Rating: 100-240V~, 50-60Hz, IEC 60320/C6, Output Rating: 60W, 5V, 9V, 15V, 20V, PPS(3.6-11V), PPS(3.6V-16V), PPS(3.6-20V)V@4.6A, 4.4A, 3.6A, 3.0A, 4.0A, 3.5A, 3.0AA, Output Configuration: 1500 mm, 2C 20 + 3C 28/5C + Shield Cond, N/A, USB Type-C Connector, Shielded, Unibody, Rugged, Ferrite: None, GlobTek Black, GT Cord # C51824, Pin Out: +V: A4, A9, B4, B9, GND: A1, A12, B1, B12, CC1: A5, D+:A6, D-:A7, Blades/Input Cord: R-Series Desktop Insert, Approvals: LPS 60950; RCM; EAC; CE; China RoHS; Level VI; PSE; RoHS; VCCI; WEEE; Class I; Ukraine; CB 60601-1 2MOPP (6W max); CB 60950; CB 62368 (pending); CCC; ETL 62368; ETL; cETLus 60601-1 3rd; cETLus 60601; RCM; S-Mark 60950; UKCA; Conforms to 62368-1; Morocco;	
	Model No. GTM96605-G2A1-R3A(PPS)	
	Part No./Ordering No. RR9LZ3000USBCPPS(R6B)	Rev A7

OUTPUT CONNECTOR HOOK UP

TO ADDRESS SYSTEM-LEVEL EMI CONCERNS, FERRITE CHOKES/BEADS MAY BE ADDED/REVISED UPON REQUEST. A SAMPLE KIT OF GLOBTEK'S STANDARD FERRITES IS AVAILABLE UNDER GLOBTEK P/N: EMI-MITIGATION-KIT1

FOR ADDITIONAL INFORMATION, PLEASE READ OUR WHITE PAPER AT:

<https://en.globtek.com/technical-articles/ferrite-kit-radiated-emi-suppression-kit-for-globtek-power-supplies-cable-assemblies>

GlobTek, Inc. www.globtek.com 186 Veterans Drive, Northvale, NJ 07647 Tel. (201) 784-1000 Fax (201) 784-0111	Drawing Title: GTM96605-G2A1-R3A(PPS), USB Power Delivery (PD) Source, ICT/ITE/Medical, Efficiency Level: USA DOE Level VI / Eco-design Directive 2009/125/EC, (EU) 2019/1782, Case Color/Style: GlobTek Black, Wall Plug-in+Desktop Combination, USB Adaptive Power Supply AC Adaptor, Input Rating: 100-240V~, 50-60Hz, IEC 60320/C6, Output Rating: 60W, 5V, 9V, 15V, 20V, PPS(3.6-11V), PPS(3.6V-16V), PPS(3.6-20V)V@4.6A, 4.4A, 3.6A, 3.0A, 4.0A, 3.5A, 3.0AA, Output Configuration: 1500 mm, 2C 20 + 3C 28/5C + Shield Cond, N/A, USB Type-C Connector, Shielded, Unibody, Rugged, Ferrite: None, GlobTek Black, GT Cord # C51824, Pin Out: +V: A4, A9, B4, B9, GND: A1, A12, B1, B12, CC1: A5, D+:A6, D-:A7, Blades/Input Cord: R-Series Desktop Insert, Approvals: LPS 60950; RCM; EAC; CE; China RoHS; Level VI; PSE; RoHS; VCCI; WEEE; Class I; Ukraine; CB 60601-1 2MOPP (6W max); CB 60950; CB 62368 (pending); CCC; ETL 62368; ETL; cETLus 60601-1 3rd; cETLus 60601; RCM; S-Mark 60950; UKCA; Conforms to 62368-1; Morocco;	
	Model No. GTM96605-G2A1-R3A(PPS)	
	Part No./Ordering No. RR9LZ3000USBCPPS(R6B)	Rev A7

LABEL:L-1470





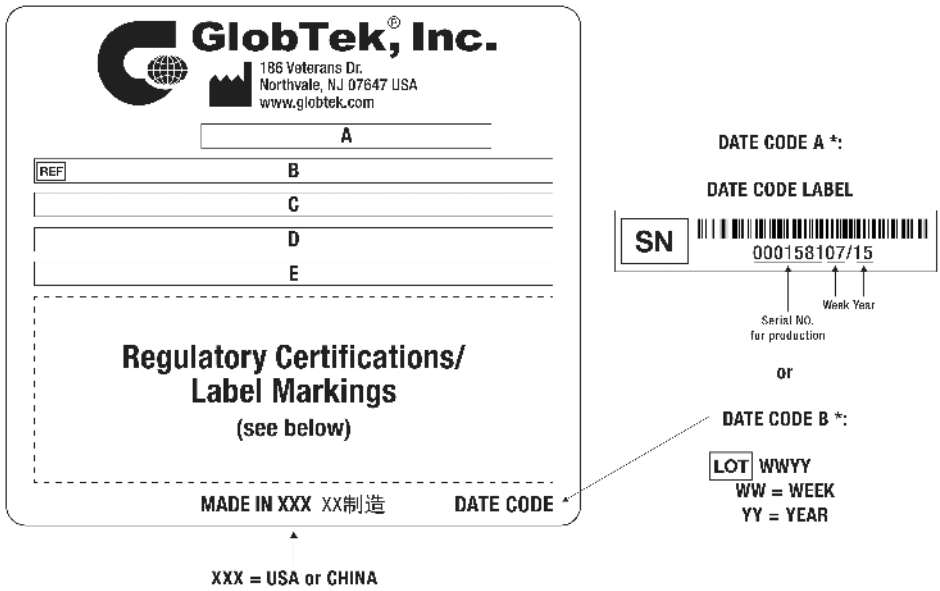

LABEL P/N	ISO 15223 medical device compliant label
MATERIAL	Flat Thermal Transfer, Imprintable, Polyester Label and/or Pad Printed and/or Molded, and/or Laser Engraved in the case
BACKGROUND COLOR	Black if housing is Black, White or Silver if housing is White or Gray.
TEXT COLOR	White or Silver if label is Black Background for Black housing. Black if label is White or Silver background and Housing is White or Gray.
SPECIAL BARCODE LABEL MATERIAL	No

Below is the minimum information which will appear on the label. NOTE: in the logo area additional/actual positioning of symbols and text is subjected to change as per agency updates/requirements or additional model approvals become available. Agency logos may be in Regulatory Certifications/Label Markings area on the label or molded into the case housing outside the label area. Information will be shown via Label and/or Pad Printed and/or Molded in the case.



A=USB Power Delivery (PD) Source, ICT/ITE/Medical
B=P/N: (料号) RR9LZ3000USBCPPS(R6B)
C=Model (型号) GTM96605-G2A1-R3A(PPS)
D=Input (输入)100-240V~, 50-60Hz, 1.5A

GlobTek, Inc. www.globtek.com 186 Veterans Drive, Northvale, NJ 07647 Tel. (201) 784-1000 Fax (201) 784-0111	Drawing Title: GTM96605-G2A1-R3A(PPS), USB Power Delivery (PD) Source, ICT/ITE/Medical, Efficiency Level: USA DOE Level VI / Eco-design Directive 2009/125/EC, (EU) 2019/1782, Case Color/Style: GlobTek Black, Wall Plug-in+Desktop Combination, USB Adaptive Power Supply AC Adaptor, Input Rating: 100-240V~, 50-60Hz, IEC 60320/C6, Output Rating: 60W, 5V, 9V, 15V, 20V, PPS(3.6-11V), PPS(3.6V-16V), PPS(3.6-20V)V@4.6A, 4.4A, 3.6A, 3.0A, 4.0A, 3.5A, 3.0AA, Output Configuration: 1500 mm, 2C 20 + 3C 28/5C + Shield Cond, N/A, USB Type-C Connector, Shielded, Unibody, Rugged, Ferrite: None, GlobTek Black, GT Cord # C51824, Pin Out: +V: A4, A9, B4, B9, GND: A1, A12, B1, B12, CC1: A5, D+:A6, D-:A7, Blades/Input Cord: R-Series Desktop Insert, Approvals: LPS 60950; RCM; EAC; CE; China RoHS; Level VI; PSE; RoHS; VCCI; WEEE; Class I; Ukraine; CB 60601-1 2MOPP (6W max); CB 60950; CB 62368 (pending); CCC; ETL 62368; ETL; cETLus 60601-1 3rd; cETLus 60601; RCM; S-Mark 60950; UKCA; Conforms to 62368-1; Morocco;	
	Model No. GTM96605-G2A1-R3A(PPS)	
	Part No./Ordering No. RR9LZ3000USBCPPS(R6B)	Rev A7

E=Output (輸出) 5V  4.6A 9V  4.4A 15V  3.6A 20V  3.0A PPS(3.6-11V)  4.0A PPS(3.6V-16V)  3.5A PPS(3.6-20V)  3.0A F=GTF-D336-2

GlobTek, Inc. www.globtek.com 186 Veterans Drive, Northvale, NJ 07647 Tel. (201) 784-1000 Fax (201) 784-0111	Drawing Title: GTM96605-G2A1-R3A(PPS), USB Power Delivery (PD) Source, ICT/ITE/Medical, Efficiency Level: USA DOE Level VI / Eco-design Directive 2009/125/EC, (EU) 2019/1782, Case Color/Style: GlobTek Black, Wall Plug-in+Desktop Combination, USB Adaptive Power Supply AC Adaptor, Input Rating: 100-240V~, 50-60Hz, IEC 60320/C6, Output Rating: 60W, 5V, 9V, 15V, 20V, PPS(3.6-11V), PPS(3.6V-16V), PPS(3.6-20V)V@4.6A, 4.4A, 3.6A, 3.0A, 4.0A, 3.5A, 3.0AA, Output Configuration: 1500 mm, 2C 20 + 3C 28/5C + Shield Cond, N/A, USB Type-C Connector, Shielded, Unibody, Rugged, Ferrite: None, GlobTek Black, GT Cord # C51824, Pin Out: +V: A4, A9, B4, B9, GND: A1, A12, B1, B12, CC1: A5, D+:A6, D-:A7, Blades/Input Cord: R-Series Desktop Insert, Approvals: LPS 60950; RCM; EAC; CE; China RoHS; Level VI; PSE; RoHS; VCCI; WEEE; Class I; Ukraine; CB 60601-1 2MOPP (6W max); CB 60950; CB 62368 (pending); CCC; ETL 62368; ETL; cETLus 60601-1 3rd; cETLus 60601; RCM; S-Mark 60950; UKCA; Conforms to 62368-1; Morocco;	
	Model No. GTM96605-G2A1-R3A(PPS)	
	Part No./Ordering No. RR9LZ3000USBCPPS(R6B)	Rev A7

AGENCY ONLINE DOCUMENTS	http://www.globtek.info/certs/GTM96605-GEN2/
CE EC-Declaration for Medical	http://globtek.force.com/models/ec_declaration_product?id=01t3a000004efYn&m=1
CE EC-Declaration for Industrial/Commercial/ITE	http://globtek.force.com/models/ec_declaration_product?id=01t3a000004efYn&i=2
CE EC-Declaration for Household	Contact GlobTek for more information
UKCA-Declaration for Medical	http://globtek.force.com/models/ukca_declaration_product?id=01t3a000004efYn&m=1
UKCA-Declaration for Industrial/Commercial/ITE	http://globtek.force.com/models/ukca_declaration_product?id=01t3a000004efYn&i=2
UKCA-Declaration for Household	Contact GlobTek for more information
Morocco SDoC Declaration	https://globtek.secure.force.com/models/Morocco_SDoC_Declaration?id=a000c00000PIC18EAH
RoHS/RoHS3 Declaration	https://www.globtek.com/pdf/rohs_cert/01t3a000004efYnAAI
REACH Declaration	https://www.globtek.com/pdf/iso_certificates/REACH.pdf
Conflict Minerals Declaration	https://www.globtek.com/pdf/conflict-minerals.pdf
Prop 65 Statement	https://en.globtek.com/prop-65-statement.pdf
IPXY rating is based on 3rd party testing and customers should check suitability and test system level IPXY rating before ordering.	

Regulatory Certifications/Label Markings

Below follows a link to the latest regulatory certifications and marks for this specific product. National standards as well as certification schemes are constantly changing and so is the set of certification marks and symbols applicable to this product. Various standards, marks and symbols, and certificates are subject to change at any time without notice.

Additional standards or unique country certifications are available upon request. Please contact Globtek to request a quotation.

LATEST PRODUCT/MODEL CERTIFICATIONS: <https://www.globtek.com/datasheet/w70350>

AGENCY ONLINE DOCUMENTS <http://www.globtek.info/certs/GTM96605-GEN2/>



(F2) Isolated Functional Earth for GTM96 series, Improved EMC

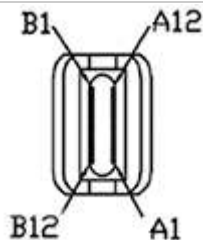

+V: A4, A9, B4, B9,
 GND: A1, A12, B1, B12,
 CC1: A5,
 D+:A6,
 D-:A7

GlobTek, Inc. www.globtek.com 186 Veterans Drive, Northvale, NJ 07647 Tel. (201) 784-1000 Fax (201) 784-0111	Drawing Title: GTM96605-G2A1-R3A(PPS), USB Power Delivery (PD) Source, ICT/ITE/Medical, Efficiency Level: USA DOE Level VI / Eco-design Directive 2009/125/EC, (EU) 2019/1782, Case Color/Style: GlobTek Black, Wall Plug-in+Desktop Combination, USB Adaptive Power Supply AC Adaptor, Input Rating: 100-240V~, 50-60Hz, IEC 60320/C6, Output Rating: 60W, 5V, 9V, 15V, 20V, PPS(3.6-11V), PPS(3.6V-16V), PPS(3.6-20V)V@4.6A, 4.4A, 3.6A, 3.0A, 4.0A, 3.5A, 3.0AA, Output Configuration: 1500 mm, 2C 20 + 3C 28/5C + Shield Cond, N/A, USB Type-C Connector, Shielded, Unibody, Rugged, Ferrite: None, GlobTek Black, GT Cord # C51824, Pin Out: +V: A4, A9, B4, B9, GND: A1, A12, B1, B12, CC1: A5, D+:A6, D-:A7, Blades/Input Cord: R-Series Desktop Insert, Approvals: LPS 60950; RCM; EAC; CE; China RoHS; Level VI; PSE; RoHS; VCCI; WEEE; Class I; Ukraine; CB 60601-1 2MOPP (6W max); CB 60950; CB 62368 (pending); CCC; ETL 62368; ETL; cETLus 60601-1 3rd; cETLus 60601; RCM; S-Mark 60950; UKCA; Conforms to 62368-1; Morocco;	
	Model No. GTM96605-G2A1-R3A(PPS)	
	Part No./Ordering No. RR9LZ3000USBCPPS(R6B)	Rev A7

PACKAGING

Packing Spec P/N	Standard DT, Cellular packaging, User manual
Box Qty	20
Gift Box Size (mm)	Egg Crate
Gift Box Color	None
Master Carton Size (mm)	427 x 405 x 158
Master Carton Cubic Volume (m ³)	0.03
Master GW (Kg)	7.0 kg
BLADES INCLUDED	R-DI: R-Series Desktop Insert
BLADE/CORD INSTALLED	R-DI: R-Series Desktop Insert
USER MANUAL*	809-DESKTOPUSERMANUAL on A4 paper
USER MANUAL WEB LINK	https://en.globtek.com/pdf/809-DESKTOPUSERMANUAL.jpg

* This specification sheet is considered the user manual for all applications. It is expected that the buyer of this product will use it to formulate their own user manual for their end product and a user manual specifically for the power adapter is not usually required. If a user manual is not specifically listed above then none will be provided with this unit.

If specific packaging is required, this section must specify all requirements and note "no exceptions". If this section does not specify packaging, it is subject to change without notice at GlobTek's discretion.

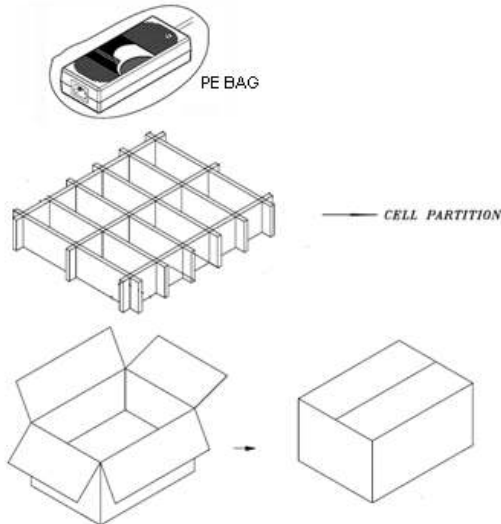

GlobTek, Inc. www.globtek.com 186 Veterans Drive, Northvale, NJ 07647 Tel. (201) 784-1000 Fax (201) 784-0111	Drawing Title: GTM96605-G2A1-R3A(PPS), USB Power Delivery (PD) Source, ICT/ITE/Medical, Efficiency Level: USA DOE Level VI / Eco-design Directive 2009/125/EC, (EU) 2019/1782, Case Color/Style: GlobTek Black, Wall Plug-in+Desktop Combination, USB Adaptive Power Supply AC Adaptor, Input Rating: 100-240V~, 50-60Hz, IEC 60320/C6, Output Rating: 60W, 5V, 9V, 15V, 20V, PPS(3.6-11V), PPS(3.6V-16V), PPS(3.6-20V)V@4.6A, 4.4A, 3.6A, 3.0A, 4.0A, 3.5A, 3.0AA, Output Configuration: 1500 mm, 2C 20 + 3C 28/5C + Shield Cond, N/A, USB Type-C Connector, Shielded, Unibody, Rugged, Ferrite: None, GlobTek Black, GT Cord # C51824, Pin Out: +V: A4, A9, B4, B9, GND: A1, A12, B1, B12, CC1: A5, D+:A6, D-:A7, Blades/Input Cord: R-Series Desktop Insert, Approvals: LPS 60950; RCM; EAC; CE; China RoHS; Level VI; PSE; RoHS; VCCI; WEEE; Class I; Ukraine; CB 60601-1 2MOPP (6W max); CB 60950; CB 62368 (pending); CCC; ETL 62368; ETL; cETLus 60601-1 3rd; cETLus 60601; RCM; S-Mark 60950; UKCA; Conforms to 62368-1; Morocco;	
	Model No. GTM96605-G2A1-R3A(PPS)	
	Part No./Ordering No. RR9LZ3000USBCPPS(R6B)	Rev A7

INSTRUCTIONS TO THE OEM SYSTEMS ENGINEER

It is the responsibility of the OEM systems engineer to provide the end system user instructions and warnings for the use of this product in the end system.

If an input cord is required for this product, AC Mains voltage should be provided to the power supply by a power supply cord approved to the national standards of the country in which it will be used.

This product is not designed to be repaired. No serviceable parts inside. A blown internal fuse is an indication of catastrophic failure of circuit component(s). If a Failure Analysis is required for a failed power supply/battery charger, please return the damaged unit to GlobTek for an accurate determination of the root cause of the failure.

EMC Compliance of the complete OEM product, including the GlobTek power supply/battery charger needs to be verified by the OEM systems engineer.

INSTRUCTION SHEET

N/A

<p>GlobTek, Inc. www.globtek.com 186 Veterans Drive, Northvale, NJ 07647 Tel. (201) 784-1000 Fax (201) 784-0111</p>	<p>Drawing Title: GTM96605-G2A1-R3A(PPS), USB Power Delivery (PD) Source, ICT/ITE/Medical, Efficiency Level: USA DOE Level VI / Eco-design Directive 2009/125/EC, (EU) 2019/1782, Case Color/Style: GlobTek Black, Wall Plug-in+Desktop Combination, USB Adaptive Power Supply AC Adaptor, Input Rating: 100-240V~, 50-60Hz, IEC 60320/C6, Output Rating: 60W, 5V, 9V, 15V, 20V, PPS(3.6-11V), PPS(3.6V-16V), PPS(3.6-20V)V@4.6A, 4.4A, 3.6A, 3.0A, 4.0A, 3.5A, 3.0AA, Output Configuration: 1500 mm, 2C 20 + 3C 28/5C + Shield Cond, N/A, USB Type-C Connector, Shielded, Unibody, Rugged, Ferrite: None, GlobTek Black, GT Cord # C51824, Pin Out: +V: A4, A9, B4, B9, GND: A1, A12, B1, B12, CC1: A5, D+:A6, D-:A7, Blades/Input Cord: R-Series Desktop Insert, Approvals: LPS 60950; RCM; EAC; CE; China RoHS; Level VI; PSE; RoHS; VCCI; WEEE; Class I; Ukraine; CB 60601-1 2MOPP (6W max); CB 60950; CB 62368 (pending); CCC; ETL 62368; ETL; cETLus 60601-1 3rd; cETLus 60601; RCM; S-Mark 60950; UKCA; Conforms to 62368-1; Morocco;</p>
	<p>Model No. GTM96605-G2A1-R3A(PPS)</p>
	<p>Part No./Ordering No. RR9LZ3000USBCPPS(R6B) Rev A7</p>

