

# HiPerFAST™ IGBT

IXGH39N60B  
IXGH39N60BD1  
IXGT39N60B  
IXGT39N60BD1

$V_{CES} = 600 \text{ V}$   
 $I_{C25} = 76 \text{ A}$   
 $V_{CE(sat)} = 1.7 \text{ V}$   
 $t_{fi} = 200 \text{ ns}$

Preliminary data

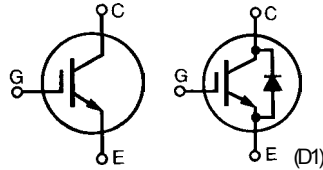

Symbol	Test Conditions	Maximum Ratings	
$V_{CES}$	$T_J = 25^\circ\text{C to } 150^\circ\text{C}$	600	V
$V_{CGR}$	$T_J = 25^\circ\text{C to } 150^\circ\text{C}; R_{GE} = 1 \text{ M}\Omega$	600	V
$V_{GES}$	Continuous	$\pm 20$	V
$V_{GEM}$	Transient	$\pm 30$	V
$I_{C25}$	$T_C = 25^\circ\text{C}$	76	A
$I_{C90}$	$T_C = 90^\circ\text{C}$	39	A
$I_{CM}$	$T_C = 25^\circ\text{C}, 1 \text{ ms}$	152	A
<b>SSOA (RBSOA)</b>	$V_{GE} = 15 \text{ V}, T_{VJ} = 125^\circ\text{C}, R_G = 22 \Omega$ Clamped inductive load	$I_{CM} = 76$ @ $0.8 V_{CES}$	A
$P_C$	$T_C = 25^\circ\text{C}$	200	W
$T_J$		-55 ... +150	$^\circ\text{C}$
$T_{JM}$		150	$^\circ\text{C}$
$T_{stg}$		-55 ... +150	$^\circ\text{C}$
Maximum lead temperature for soldering 1.6 mm (0.062 in.) from case for 10 s		300	$^\circ\text{C}$
$M_d$	Mounting torque (M3) TO-247	1.13/10Nm/lb.in.	
<b>Weight</b>		TO-247 AD	6 g
		TO-268	4 g

TO-268  
(IXGT)

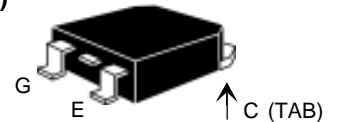

TO-247 AD  
(IXGH)

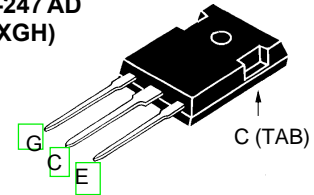

G = Gate, C = Collector,  
E = Emitter, TAB = Collector

## Features

- International standard packages JEDEC TO-247 AD & TO-268
- High current handling capability
- Newest generation HDMOS™ process
- MOS Gate turn-on - drive simplicity

## Applications

- PFC circuits
- AC motor speed control
- DC servo and robot drives
- DC choppers
- Uninterruptible power supplies (UPS)
- Switched-mode and resonant-mode power supplies

## Advantages

- High power density
- Very fast switching speeds for high frequency applications

Symbol	Test Conditions		Characteristic Values ( $T_J = 25^\circ\text{C}$ , unless otherwise specified)		
			Min.	Typ.	Max.
$BV_{CES}$	$I_C = 250 \text{ }\mu\text{A}, V_{GE} = 0 \text{ V}$	39N60B	600		V
		39N60BD1	600		
$V_{GE(th)}$	$I_C = 250 \text{ }\mu\text{A}, V_{CE} = V_{GE}$	39N60B	2.5		5.0 V
		39N60BD1	2.5		5.0 V
$I_{CES}$	$V_{CE} = 0.8 \cdot V_{CES}, V_{GE} = 0 \text{ V}$	$T_J = 25^\circ\text{C}$ 39N60B			200 $\mu\text{A}$
		$T_J = 125^\circ\text{C}$ 39N60B			1 mA
		$T_J = 125^\circ\text{C}$ 39N60BD1			3 mA
$I_{GES}$	$V_{CE} = 0 \text{ V}, V_{GE} = \pm 20 \text{ V}$				$\pm 100 \text{ nA}$
$V_{CE(sat)}$	$I_C = I_{90}, V_{GE} = 15 \text{ V}$				1.7 V

Symbol	Test Conditions	Characteristic Values (T <sub>J</sub> = 25°C, unless otherwise specified)		
		min.	typ.	max.
<b>g<sub>fs</sub></b>	I <sub>C</sub> = I <sub>C90</sub> ; V <sub>CE</sub> = 10 V, Pulse test, t ≤ 300 ∞s, duty cycle ≤ 2 %	19	28	S
<b>C<sub>ies</sub></b>	V <sub>CE</sub> = 25 V, V <sub>GE</sub> = 0 V, f = 1 MHz		2750	pF
<b>C<sub>oes</sub></b>		39N60B	200	pF
<b>C<sub>res</sub></b>		39N60BD1	240	pF
<b>Q<sub>G</sub></b>	I <sub>C</sub> = I <sub>C90</sub> , V <sub>GE</sub> = 15 V, V <sub>CE</sub> = 0.5 V <sub>CES</sub>		110	150 nC
<b>Q<sub>GE</sub></b>			25	35 nC
<b>Q<sub>GC</sub></b>			40	75 nC
<b>t<sub>d(on)</sub></b>	<b>Inductive load, T<sub>J</sub> = 25°C</b> I <sub>C</sub> = I <sub>C90</sub> , V <sub>GE</sub> = 15 V V <sub>CE</sub> = 0.8 V <sub>CES</sub> , R <sub>G</sub> = R <sub>off</sub> = 4.7 Ω Remarks: Switching times may increase for V <sub>CE</sub> (Clamp) > 0.8 • V <sub>CES</sub> , higher T <sub>J</sub> or increased R <sub>G</sub>		25	ns
<b>t<sub>ri</sub></b>			30	ns
<b>t<sub>d(off)</sub></b>			250	500 ns
<b>t<sub>fi</sub></b>			200	360 ns
<b>E<sub>off</sub></b>			4.0	6.0 mJ
<b>t<sub>d(on)</sub></b>		<b>Inductive load, T<sub>J</sub> = 125°C</b> I <sub>C</sub> = I <sub>C90</sub> , V <sub>GE</sub> = 15 V V <sub>CE</sub> = 0.8 V <sub>CES</sub> , R <sub>G</sub> = R <sub>off</sub> = 4.7 Ω Remarks: Switching times may increase for V <sub>CE</sub> (Clamp) > 0.8 • V <sub>CES</sub> , higher T <sub>J</sub> or increased R <sub>G</sub>		25
<b>t<sub>ri</sub></b>			30	ns
<b>E<sub>on</sub></b>			0.3	mJ
<b>t<sub>d(off)</sub></b>			360	ns
<b>t<sub>fi</sub></b>			350	ns
<b>E<sub>off</sub></b>			6.0	mJ
<b>R<sub>thJC</sub></b>			0.62	K/W
<b>R<sub>thCK</sub></b>		0.25		K/W

Symbol	Test Conditions	Characteristic Values (T <sub>J</sub> = 25°C, unless otherwise specified)		
		min.	typ.	max.
<b>V<sub>F</sub></b>	I <sub>F</sub> = I <sub>C90</sub> , V <sub>GE</sub> = 0 V, Pulse test t ≤ 300 ∞s, duty cycle d ≤ 2 %	T <sub>J</sub> = 150°C		1.6 V
		T <sub>J</sub> = 25°C		2.5 V
<b>I<sub>RM</sub></b>	I <sub>F</sub> = I <sub>C90</sub> , V <sub>GE</sub> = 0 V, -di <sub>F</sub> /dt = 100 A/∞s V <sub>R</sub> = 100 V I <sub>F</sub> = 1 A; -di <sub>F</sub> /dt = 100 A/∞s; V <sub>R</sub> = 30 V		6	A
<b>t<sub>tr</sub></b>		T <sub>J</sub> = 100°C	100	ns
		T <sub>J</sub> = 25°C	25	ns
<b>R<sub>thJC</sub></b>			0.9	K/W

**TO-247 AD Outline**

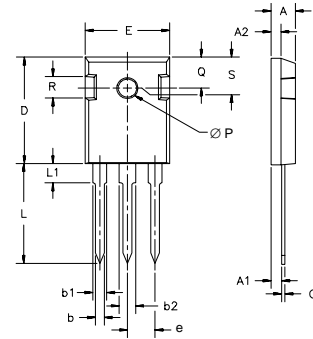

Dim.	Millimeter		Inches	
	Min.	Max.	Min.	Max.
A	4.7	5.3	.185	.209
A <sub>1</sub>	2.2	2.54	.087	.102
A <sub>2</sub>	2.2	2.6	.059	.098
b	1.0	1.4	.040	.055
b <sub>1</sub>	1.65	2.13	.065	.084
b <sub>2</sub>	2.87	3.12	.113	.123
C	.4	.8	.016	.031
D	20.80	21.46	.819	.845
E	15.75	16.26	.610	.640
e	5.20	5.72	0.205	0.225
L	19.81	20.32	.780	.800
L1		4.50		.177
∅P	3.55	3.65	.140	.144
Q	5.89	6.40	0.232	0.252
R	4.32	5.49	.170	.216
S	6.15	BSC	.242	BSC

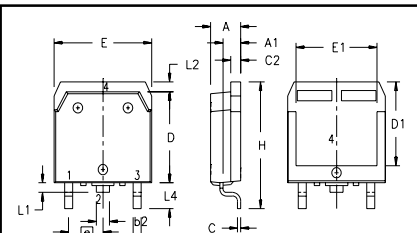

SYM	INCHES		MILLIMETERS	
	MIN	MAX	MIN	MAX
A	.193	.201	4.90	5.10
A1	.106	.114	2.70	2.90
A2	.001	.010	0.02	0.25
b	.045	.057	1.15	1.45
b2	.075	.083	1.90	2.10
C	.016	.026	0.40	0.65
C2	.057	.063	1.45	1.60
D	.543	.551	13.80	14.00
D1	.488	.500	12.40	12.70
E	.624	.632	15.85	16.05
E1	.524	.535	13.30	13.60
e		.215 BSC		5.45 BSC
H	.736	.752	18.70	19.10
L	.094	.106	2.40	2.70
L1	.047	.055	1.20	1.40
L2	.039	.045	1.00	1.15
L3	.010	BSC	0.25	BSC
L4	.150	.161	3.80	4.10

IXYS reserves the right to change limits, test conditions, and dimensions.

**Fig. 1. Saturation Voltage Characteristics @ 25 Deg. C**

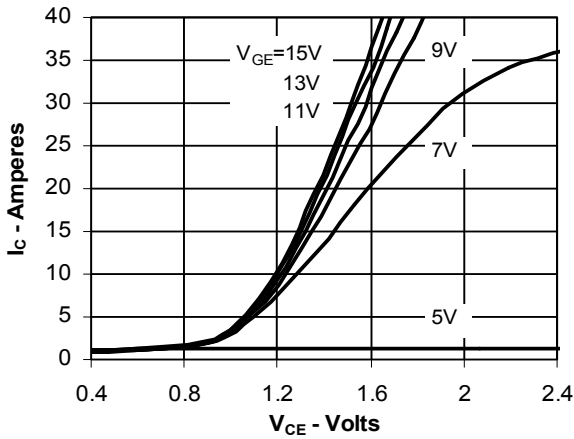

**Fig. 2. Extended Output Characteristics @ 25 Deg. C**

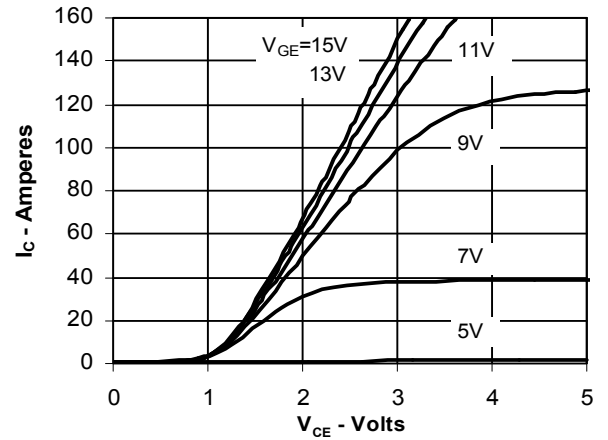

**Fig. 3. Saturation Voltage Characteristics @ 125 Deg. C**

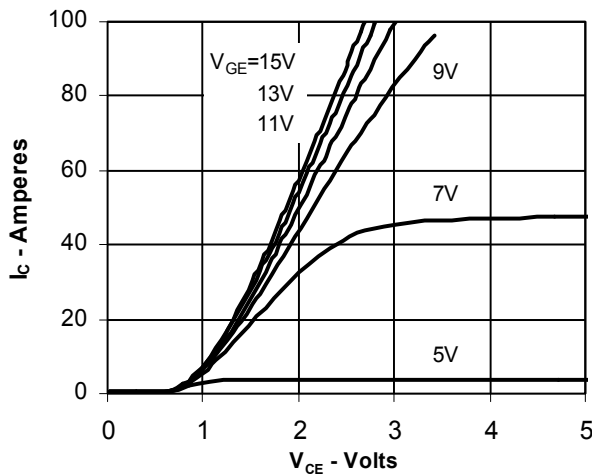

**Fig. 4. Temperature Dependence of  $V_{CE(SAT)}$**

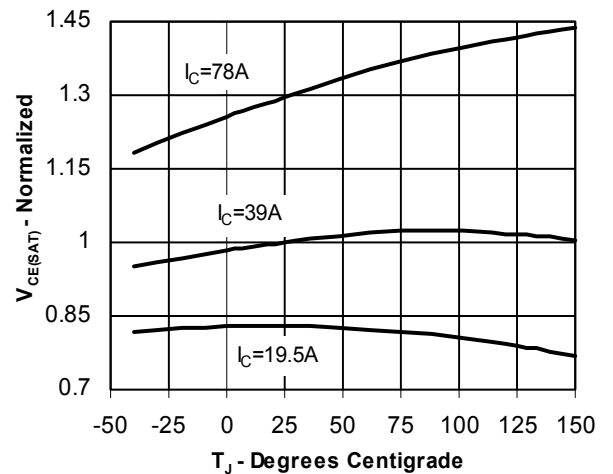

**Fig. 5.  $BV_{CES}$  &  $V_{(GE)TH}$  vs. Junction Temperature**

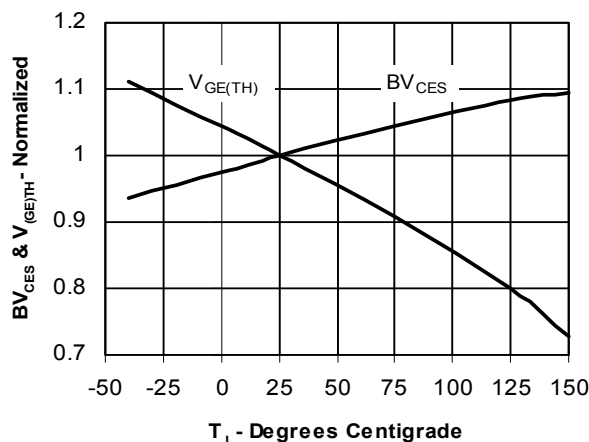

**Fig. 6. Admittance**

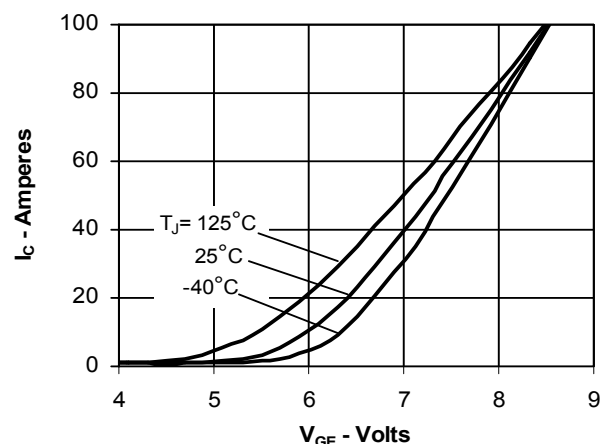

Fig. 7. Transconductance

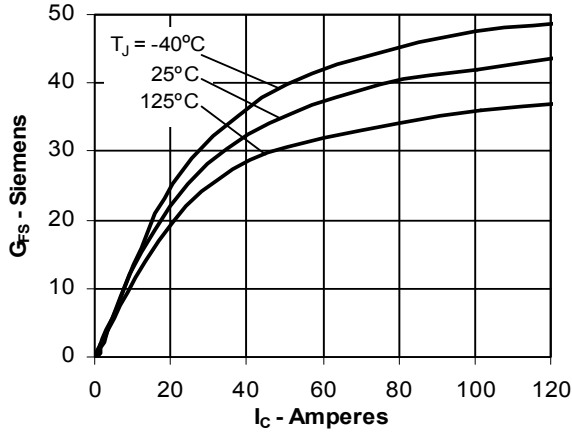

Fig. 8. Dependence of  $E_{OFF}$  on  $I_c$

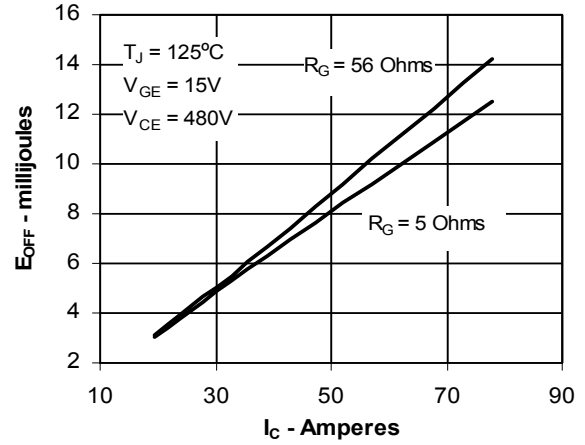

Fig. 9. Dependence of  $E_{OFF}$  on  $R_G$

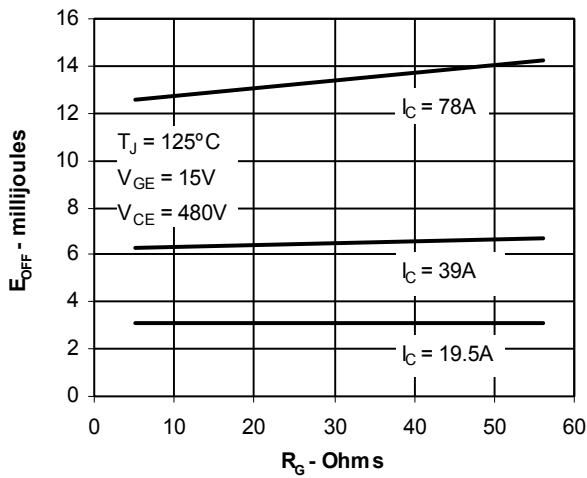

Fig. 10. Dependence of  $E_{OFF}$  on Temperature

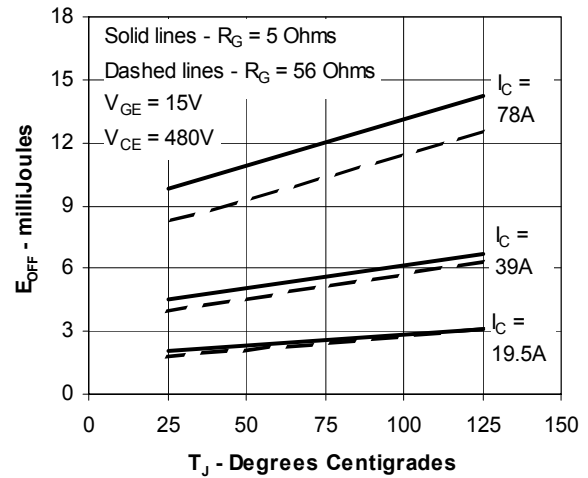

Fig. 11. Gate Charge

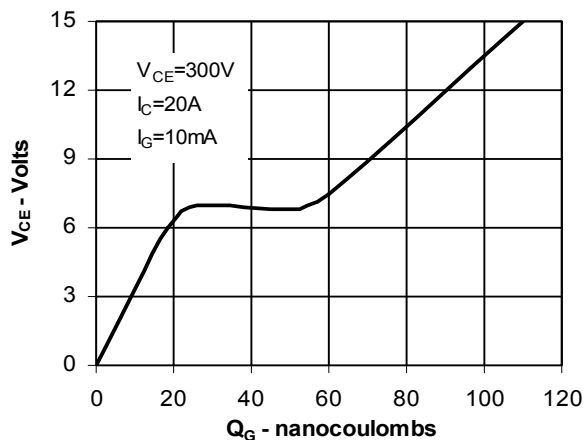
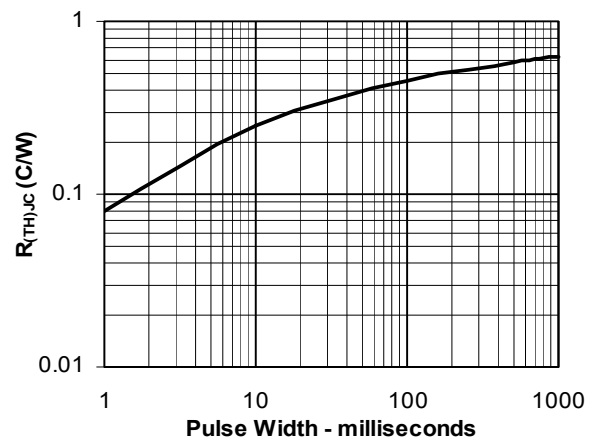

Fig. 12. Transient Thermal Response



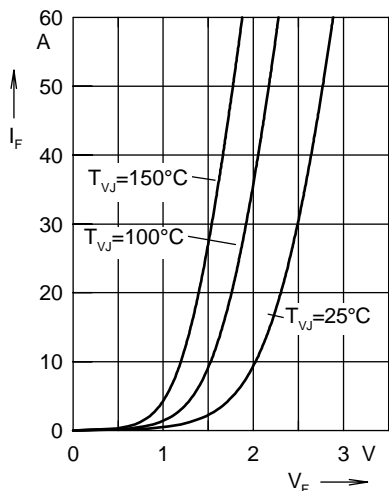

Fig. 12 Forward current  $I_F$  versus  $V_F$

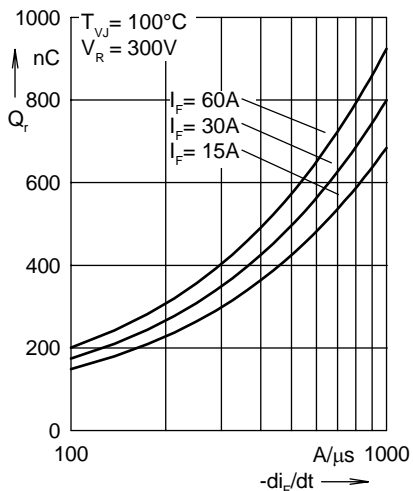

Fig. 13 Reverse recovery charge  $Q_r$  versus  $-di_F/dt$

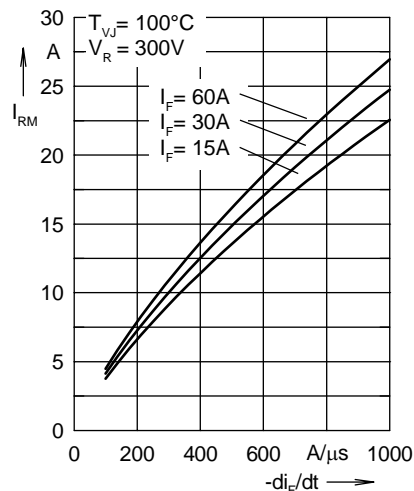

Fig. 14 Peak reverse current  $I_{RM}$  versus  $-di_F/dt$

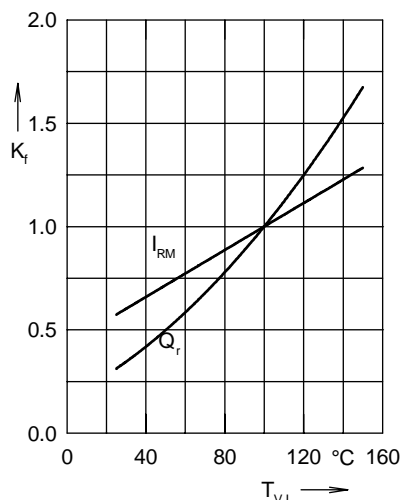

Fig. 15 Dynamic parameters  $Q_r, I_{RM}$  versus  $T_{VJ}$

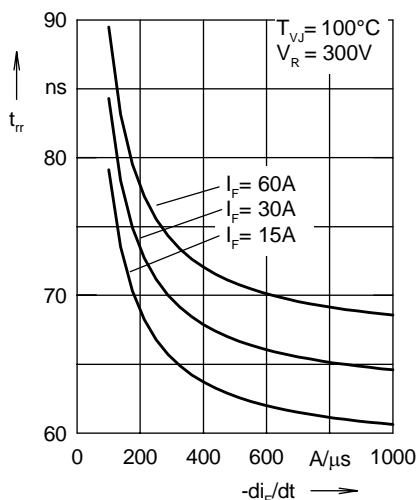

Fig. 16 Recovery time  $t_{rr}$  versus  $-di_F/dt$

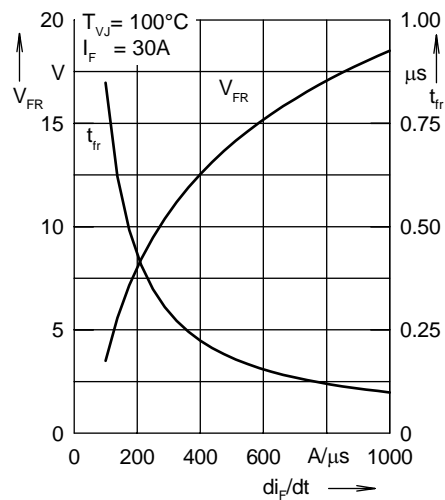

Fig. 17 Peak forward voltage  $V_{FR}$  and  $t_{rr}$  versus  $di_F/dt$

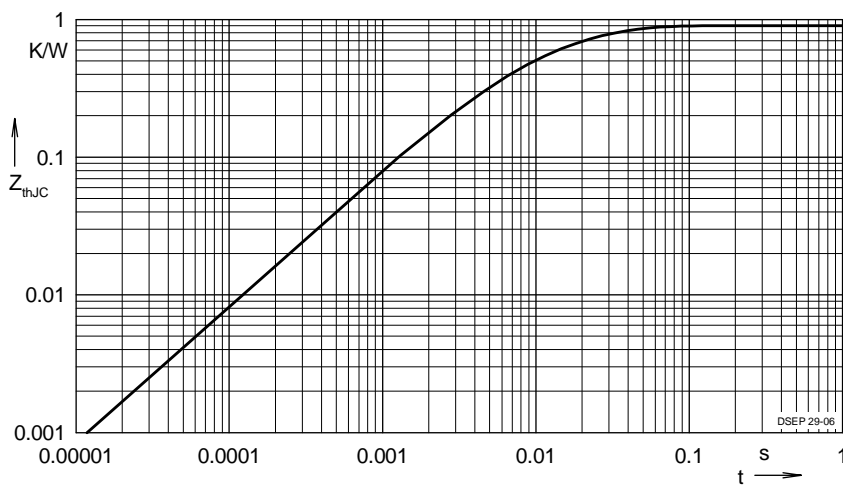

Fig. 18 Transient thermal resistance junction to case

Constants for  $Z_{thJC}$  calculation:

i	$R_{thi}$ (K/W)	$t_i$ (s)
1	0.502	0.0052
2	0.193	0.0003
3	0.205	0.0162