

LTC3869EUFD

Dual, 2-Phase Synchronous Step-Down DC/DC Controllers

DESCRIPTION

Demonstration circuit 1807A is a dual output, dual phase synchronous buck converter featuring the LTC3869EUFD. The demo board uses a high density, two sided drop-in layout. The power components, excluding the bulk output and input capacitors, fit within a 1.35" × 0.75" area on the top layer. The control circuit resides in a 0.60" × 0.75" area on the bottom layer. The package style for the LTC3869EUFD is a 4mm × 5mm 28-lead QFN with an exposed ground pad.

The main features of the board include an internal 5V linear regulator for bias, RUN pins for each output, an EXT_{VCC} pin and a PGOOD signal. The board can be configured for either CCM (original setting), Burst Mode operation, or pulse-skipping operation with the mode jumper. The board also has optional resistors for single output/dual phase operation, rail tracking and synchronization to an external clock.

Two versions of the board are available. DC1807A-A has an on-board sense resistor for current feedback, while the DC1807A-B is configured with a DCR sense circuit that allows the converter to use the inductors DCR as the sense element instead of the on-board sense resistors to save cost and board space and improves efficiency.

The input voltage range is 4.5V to 14V, output voltages and currents are 1.5V/15A and 1.2V/15A. The LTC3869 datasheet gives a complete description of the part, operation and application information. The datasheet must be read in conjunction with this demo manual for DC1807A.

Design files for this circuit board are available at <http://www.linear.com/demo>

LT, LT, LTC, LTM, µModule, Burst Mode, Linear Technology and the Linear logo are registered trademarks of Linear Technology Corporation. All other trademarks are the property of their respective owners.

PERFORMANCE SUMMARY (T_A = 25°C)

PARAMETER	CONDITIONS	VALUE	
Minimum Input Voltage		4.5V	
Maximum Input Voltage		14V	
Output Voltage V _{OUT1}	V _{IN} = 4.5V to 14V, I _{OUT1} = 0A to 15A	1.5V±2%	
Output Voltage V _{OUT2}	V _{IN} = 4.5V to 14V, I _{OUT2} = 0A to 15A	1.2V±2%	
Typical Output Ripple V _{OUT}	V _{IN} = 12V, I _{OUT1} = 15A (20MHz BW)	<30mV _{P-P} *	
	V _{IN} = 12V, I _{OUT2} = 15A (20MHz BW)	<30mV _{P-P} *	
Nominal Switching Frequency		400kHz	
Efficiency		DC1807A-A	DC1807A-B
	V _{OUT1} = 1.5V, I _{OUT1} = 15A; V _{IN} = 12V	88.7%** Typical	86.7%** Typical
	V _{OUT2} = 1.2V, I _{OUT2} = 15A; V _{IN} = 12V	89.1%** Typical	87.4%** Typical

*Measured at bulk output capacitor

**See Figures 3 and 4 for efficiency curves

DEMO MANUAL DC1807A

QUICK START PROCEDURE

Demonstration circuit 1807A is easy to set up to evaluate the performance of the LTC3869EUFD. Refer to Figure 1 for proper measurement equipment setup and follow the procedure below:

NOTE. When measuring the input or output voltage ripple, care must be taken to avoid a long ground lead on the oscilloscope probe. Measure the input or output voltage ripple by touching the probe tip directly across the V_{IN} or V_{OUT} and GND terminals. See Figure 2 for proper scope probe technique.

1. Make sure jumpers are in the following positions:

JUMPER	POSITION
JP1	ON
JP2	ON
JP3	CCM

2. With power off, connect the input power supply to V_{IN} and GND. Connect active loads to outputs.

3. Turn on the power at the input.

NOTE. Make sure that the input voltage does not exceed 28V.

4. Check for the proper output voltages.

$$V_{OUT1} = 1.470V \text{ to } 1.530V,$$

$$V_{OUT2} = 1.176V \text{ to } 1.224V,$$

NOTE. If there is no output, temporarily disconnect the load to make sure that the load is not set too high.

5. Once the proper output voltages are established, adjust the loads within the operating range and observe the output voltage regulation, ripple voltage, efficiency and other parameters.

6. Different operating modes can be evaluated by changing position of jumper JP3.

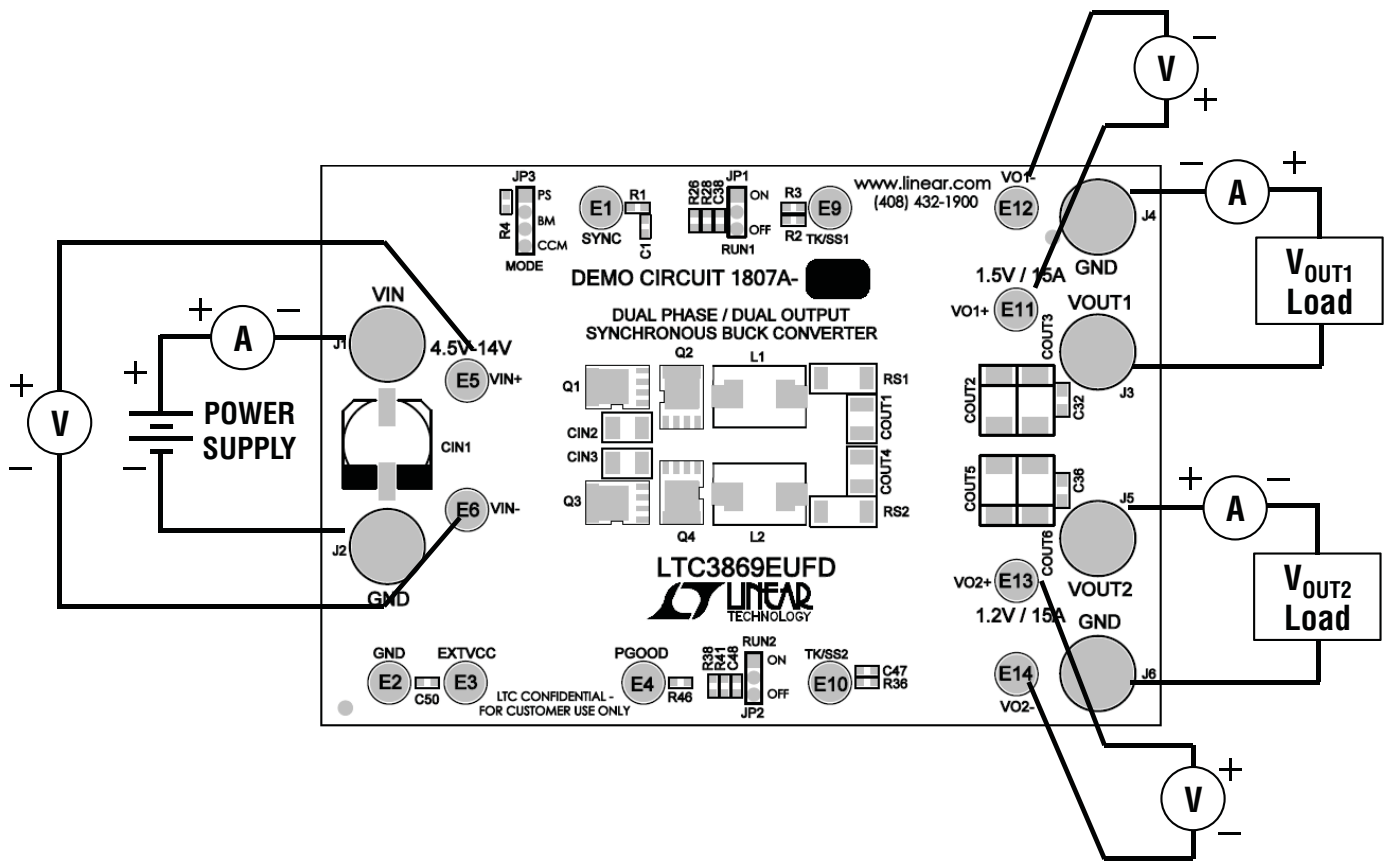

Figure 1. Proper Measurement Equipment Setup

dc1807af

QUICK START PROCEDURE

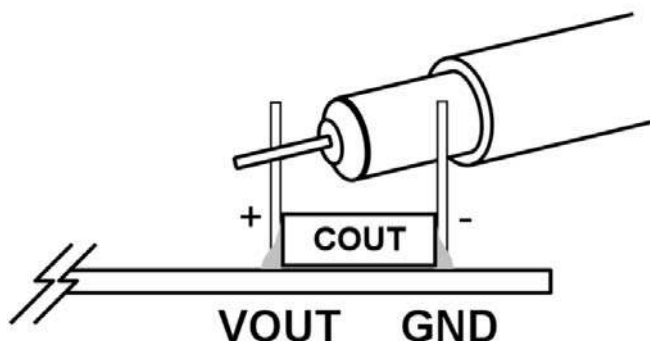

Figure 2. Measuring Output Voltage Ripple

Rail Tracking

Demonstration circuit 1807A is setup for independent turn-on of V_{OUT1} and V_{OUT2} . The ramp-rate for V_{OUT1} is determined by the TRK/SS1 cap at C2 and the ramp-rate for V_{OUT2} is determined by the TRK/SS2 cap at C47. The turn-on of one rail will not affect the other for the original demo board.

This board can be modified on the bench to allow V_{OUT1} to track an external signal. It can also be modified to allow V_{OUT2} to track V_{OUT1} or to allow V_{OUT2} to track an external signal. Tables 2 and 3 cover the rail tracking options for each rail, with the –B version used as an example.

Table.1 V_{OUT1} Tracking Options for a 1.5V Output.

CONFIGURATION	TRACK 1 DIVIDER		TRK/SS1 CAPACITOR
	R3	R2	C2
Soft Start Without Tracking	0 Ω	OPEN	0.1 μ F
External Coincident Tracking	17.8k Ω	20.0k Ω	OPEN

Table.2 V_{OUT2} Tracking Options for a 1.2V Output.

CONFIGURATION	TRACK 2 DIVIDER			TRK/SS2 CAPACITOR
	R36	R34	R37	C47
Soft Start Without Tracking	0 Ω	OPEN	OPEN	0.1 μ F
Coincident Tracking to V_{OUT1} (1.5V)	0 Ω	10.0k Ω	20.0k Ω	OPEN
External Coincident Tracking	17.8k Ω	OPEN	20.0k Ω	OPEN

Single Output/Dual Phase Operation

A single output/dual phase converter may be preferred for high output current applications. The benefits of single output/dual phase operation is lower ripple current through the input and output capacitors, improved load step response and simplified thermal design. To implement single output / dual phase operation, make the following modifications:

1. Tie V_{OUT1} to V_{OUT2} by tying together the exposed copper pads near J3 and J5 at the edge of the board. Use a piece of heavy copper foil.
2. Tie ITH1 to ITH2 by stuffing 0 at R49. Turn on the power at the input.
3. Tie VFB1 to VFB2 by stuffing 0 at R50.
4. Tie TRK/SS1 to TRK/SS2 by stuffing 0 at R52.
5. Tie RUN1 to RUN2 by stuffing 0 at R55.
6. Remove the redundant ITH compensation network and VFB divider.

QUICK START PROCEDURE

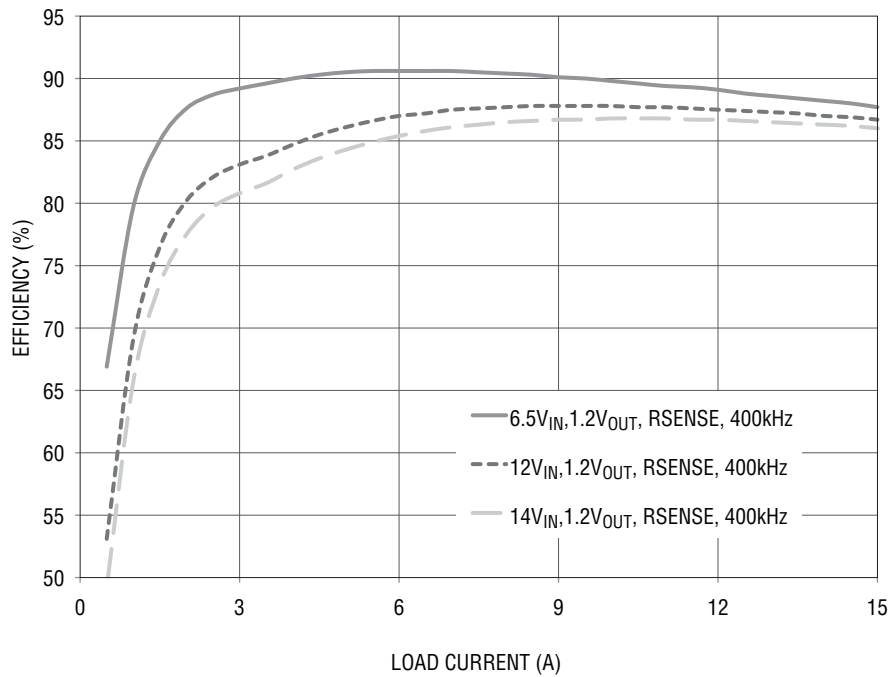
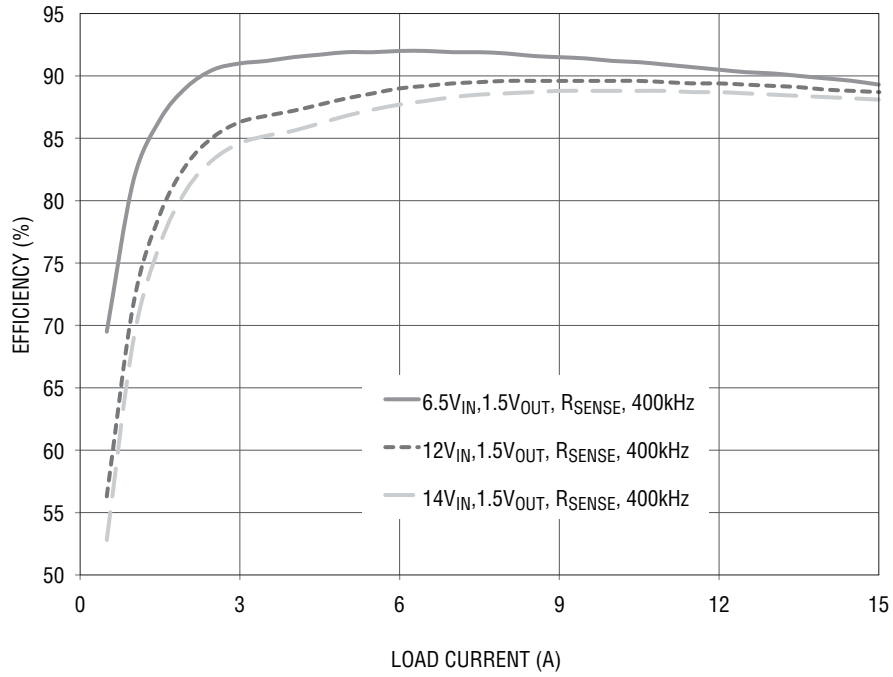

Figure 3. Typical Efficiency Curves vs Load Current with A-A (R_{SENSE}) Board for: (A) 1.5V Rail and (B) 1.2V Rail

QUICK START PROCEDURE

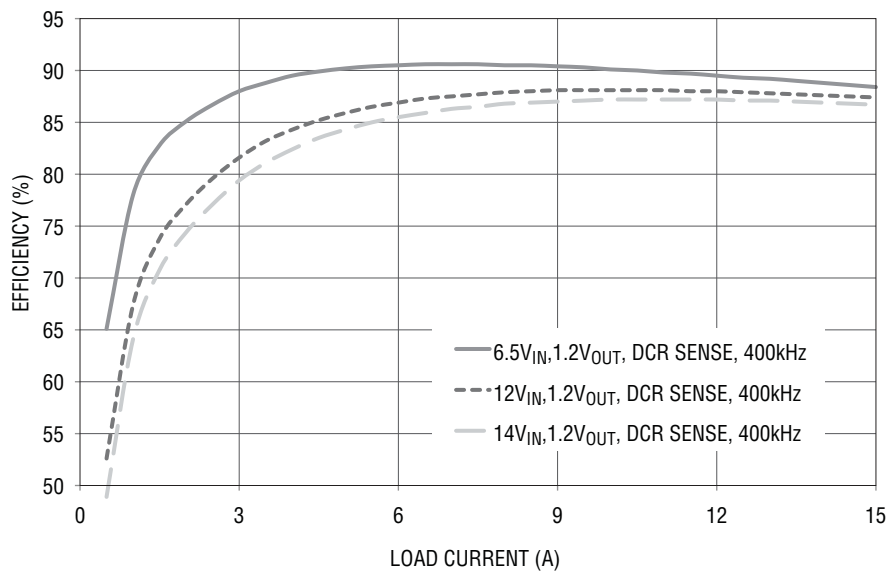
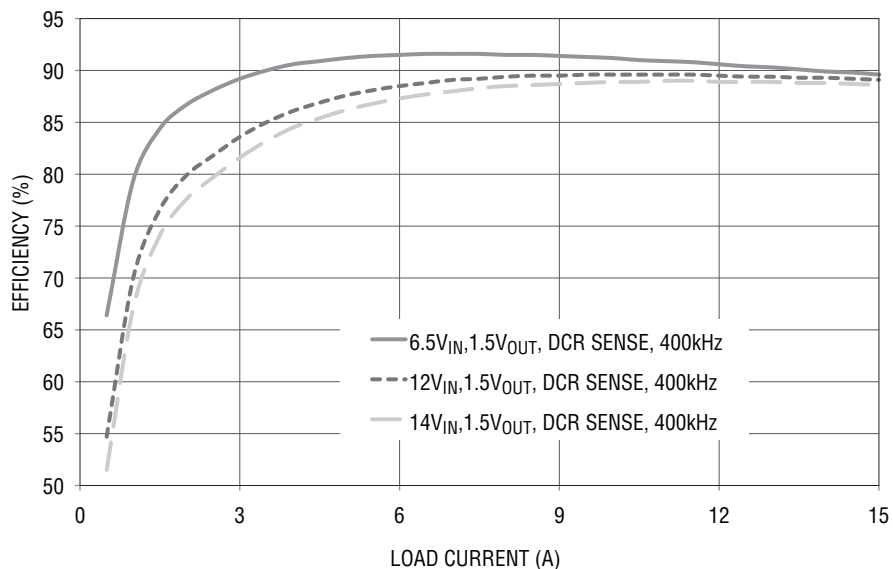

Figure 4. Typical Efficiency Curves vs Load Current with A-B (DCR Sense) Board for: (A) 1.5V Rail and (B) 1.2V Rail

DEMO MANUAL DC1807A

PARTS LIST

ITEM	QTY	REFERENCE	PART DESCRIPTION	MANUFACTURER/PART NUMBER
Required Circuit Components				
1	1	C _{IN1}	CAP, 180µF 20% 16V OSCON	SANYO OSCON 16SVP180MX
2	2	C _{IN2} , C _{IN3}	CAP, 1210 10µF 10% 16V X5R	TAIYO YUDEN EMK325BJ106KN-T
3	2	C _{OUT1} , C _{OUT4}	CAP, 1210 100µF 20% 6.3V X5R	TDK C3225X5R0J107MT
4	4	C _{OUT2} , C _{OUT3} , C _{OUT5} , C _{OUT6}	CAP, 7343 330µF 20% 2.5V POSCAP	SANYO 2R5TPE330M9
5	5	C2, C17, C20, C21, C47	CAP, 0603 0.1µF 10% 25V X7R	TDK C1608X7R1E104K
6	3	C11, C32, C36	CAP, 0805 4.7µF 10% 6.3V X5R	AVX 08056D475KAT
7	1	C42	CAP, 0603 100pF 5% 25V X7R	AVX 06033C101JAT
8	1	C43	CAP, 0603 220pF 5% 25V X7R	AVX 06033C221JAT2A
9	1	C50	CAP, 0603 1µF 20% 16V X7R	AVX 0603YC105MAT2A
10	2	C14, C15, C41, C44	CAP, 0603 1nF 10% 50V X7R	AVX 06035C102KAT
11	2	D1, D2	DIODE,CMDSH-3 SOD323	CENTRAL CMDSH-3-LTC
12	2	Q1, Q3	XSTR, N-CHANNEL MOSFET	INFINEON BC050NE2LS
13	2	Q2, Q4	XSTR, N-CHANNEL MOSFET	INFINEON BSC010NE2LS
14	2	RS1, RS2	RES, 2010 0.002Ω 5% 1/2W	VISHAY WSL20102L000FEA
15	7	R1, R3, R9, R25, R36, R48, R54	RES, 0603 0Ω JUMPER	PANASONIC ERJ3GGEY0R00V
16	4	R29, R30, R39, R40	RES, 0603 100Ω 5% 1/10W	VISHAY CRCW0603100RJNEA
17	1	R4	RES, 0603 10kΩ 1% 1/16W	VISHAY CRCW060310K0FKEB
18	1	R18	RES, 0603 2.2Ω 5% 1/10W	YAYEO RC0603JR-072R2
19	1	R27	RES, 0603 30.1kΩ 1% 1/10W	YAYEO RC0603FR-0730K1
20	2	R31, R35	RES, 0603 5.9kΩ 1% 1/10W	VISHAY CRCW06035K9FKEA
21	3	R32, R33, R43	RES, 0603 20kΩ 1% 1/10W	YAYEO RC0603FR-0720K
22	1	R10	RES, 0603 102kΩ 5% 1/10W	VISHAY CRCW0603102KJNEA
23	1	R46	RES, 0603 100kΩ 5% 1/10W	VISHAY CRCW0603100KJNEB
24	1	U1	IC, Dual, 2-Phase Synchronous Step-Down DC/DC Controllers	LINEAR TECH.LTC3869EUFD
25	2	L1, L2	IND, 0.47µH	VITEC 59PR9875, 0.4µH
Additional Circuit Components				
1	0	C _{IN4} , C _{IN5}	CAP, 1210 OPTION	OPTION
2	0	C1,C37,C38,C48,C49	CAP, 0603 OPTION	OPTION
3	0	R2, R26, R28, R34, R37, R38, R41, R42, R44, R45, R47, R49, R50, R51, R52, R53, R55, R60, R61, R62	RES, 0603 OPTION	OPTION
4	0	Q5, Q6, Q7, Q8	DO NOT STUFF	OPTION
Hardware				
1	12	E1-E6, E9-E14	TURRET	MILL-MAX 2501-2-00-80-00-00-07-0
2	2	JP1, JP2	HEADER, 3 PIN, 2mm	SAMTEC TMM-103-02-L-S
3	1	JP3	HEADER, 4 PIN	SAMTEC TMM-104-02--L-S
4	6	J1, J2, J3, J4, J5, J6	JACK, BANANA	KEYSTONE 575-4
5	3	JP1-JP3	SHUNT, 2mm	SAMTEC 2SN-BK-G

SCHEMATIC DIAGRAM

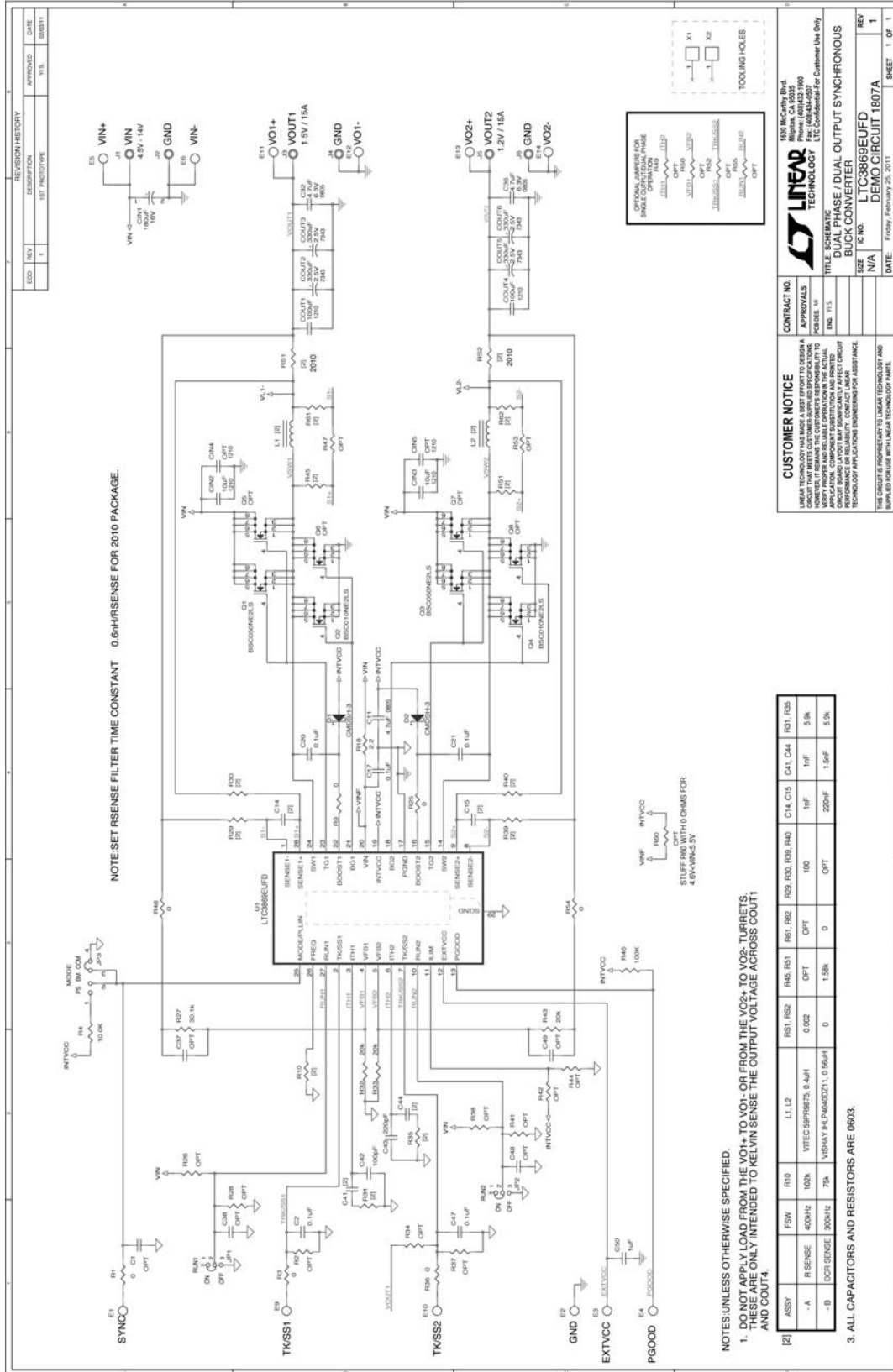

Information furnished by Linear Technology Corporation is believed to be accurate and reliable. However, no responsibility is assumed for its use. Linear Technology Corporation makes no representation that the interconnection of its circuits as described herein will not infringe on existing patent rights.

DEMO MANUAL DC1807A

DEMONSTRATION BOARD IMPORTANT NOTICE

Linear Technology Corporation (LTC) provides the enclosed product(s) under the following **AS IS** conditions:

This demonstration board (DEMO BOARD) kit being sold or provided by Linear Technology is intended for use for **ENGINEERING DEVELOPMENT OR EVALUATION PURPOSES ONLY** and is not provided by LTC for commercial use. As such, the DEMO BOARD herein may not be complete in terms of required design-, marketing-, and/or manufacturing-related protective considerations, including but not limited to product safety measures typically found in finished commercial goods. As a prototype, this product does not fall within the scope of the European Union directive on electromagnetic compatibility and therefore may or may not meet the technical requirements of the directive, or other regulations.

If this evaluation kit does not meet the specifications recited in the DEMO BOARD manual the kit may be returned within 30 days from the date of delivery for a full refund. **THE FOREGOING WARRANTY IS THE EXCLUSIVE WARRANTY MADE BY THE SELLER TO BUYER AND IS IN LIEU OF ALL OTHER WARRANTIES, EXPRESSED, IMPLIED, OR STATUTORY, INCLUDING ANY WARRANTY OF MERCHANTABILITY OR FITNESS FOR ANY PARTICULAR PURPOSE. EXCEPT TO THE EXTENT OF THIS INDEMNITY, NEITHER PARTY SHALL BE LIABLE TO THE OTHER FOR ANY INDIRECT, SPECIAL, INCIDENTAL, OR CONSEQUENTIAL DAMAGES.**

The user assumes all responsibility and liability for proper and safe handling of the goods. Further, the user releases LTC from all claims arising from the handling or use of the goods. Due to the open construction of the product, it is the user's responsibility to take any and all appropriate precautions with regard to electrostatic discharge. Also be aware that the products herein may not be regulatory compliant or agency certified (FCC, UL, CE, etc.).

No License is granted under any patent right or other intellectual property whatsoever. **LTC assumes no liability for applications assistance, customer product design, software performance, or infringement of patents or any other intellectual property rights of any kind.**

LTC currently services a variety of customers for products around the world, and therefore this transaction **is not exclusive**.

Please read the DEMO BOARD manual prior to handling the product. Persons handling this product must have electronics training and observe good laboratory practice standards. **Common sense is encouraged.**

This notice contains important safety information about temperatures and voltages. For further safety concerns, please contact a LTC application engineer.

Mailing Address:

Linear Technology
1630 McCarthy Blvd.
Milpitas, CA 95035

Copyright © 2004, Linear Technology Corporation