



**SPECIFICATION SHEET**

<b>SPECIFICATION SHEET NO.</b>	N1004- SOD5235Z15VSZN
<b>DATE</b>	Oct. 04, 2021
<b>REVISION</b>	A0
<b>DESCRIPTION</b>	<p>SMD Plastic-Encapsulate ESD Protection Diodes, SOD-523 series, 2 pads ESD5Z15V Type, TVs for ESD protection</p> <p>Reverse Working Voltage : 15V, Clamping Voltage 23.0VC Max.</p> <p>Operating Temp. Range -55°C ~+150°C, Package in Tape/Reel, 3000pcs/Reel RoHS/RoHS III compliant</p>
<b>CUSTOMER</b>	
<b>CUSTOMER PART NUMBER</b>	
<b>CROSS REF. PART NUMBER</b>	
<b>ORIGINAL PART NUMBER</b>	MDD ESD5Z15V
<b>PART CODE</b>	SOD5235Z15VSZN

<b>VENDOR APPROVE</b>			
Issued/Checked/Approved			
DATE: Oct. 04, 2021			

<b>CUSTOMER APPROVE</b>	
DATE:	

**SMD ESD PROTECTION DIODES SOD-523 SERIES**

**MAIN FEATURE**

- IEC61000-4-2 (ESD) level 4 ESD Protection
- Protects one directional I/O line
- Low clamping voltage
- Low leakage current
- Working voltages : 5V
- Flammability Rating: UL 94V-0
- High temperature soldering recommended : 260°C/10s



**APPLICATION**

- Cell phone handsets and accessories
- Microprocessor based equipment
- Notebooks, Desktops, and Servers Cellular
- Personal digital assistants (PDA)
- Portable Instrumentation
- Peripherals

**RFQ**

[Request For Quotation](#)

**PART CODE GUIDE**

SOD523	5Z15V	S	ZN
1	2	3	4

- 1) **SOD523**: SMD Plastic-Encapsulate ESD Protection Diodes, SOD-523 series, 2 pads
- 2) **5Z15V**: Type code for original part number ESD5Z15V
- 3) **S**: Package code, Package in Tape/Reel, 3000pcs/Reel
- 4) **0ZN**: Marking code for “ZN” on the case surface, Different Marking for different specification.

**MORE ITEMS AVAILABLE**

SOD5235Z2V5SZD	SOD5235Z3V3SZE	SOD5235Z5V0SZF	SOD5235Z6V0SZG	SOD5235Z7V0SZH
<b>SOD5235Z12VSZM</b>	SOD5235Z15VSZN			

**SMD ESD PROTECTION DIODES SOD-523 SERIES**

**DIMENSION (Unit: Inch/mm)**

Image for reference

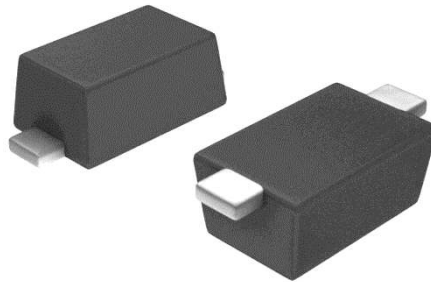

Marking: ZN

SOD-523

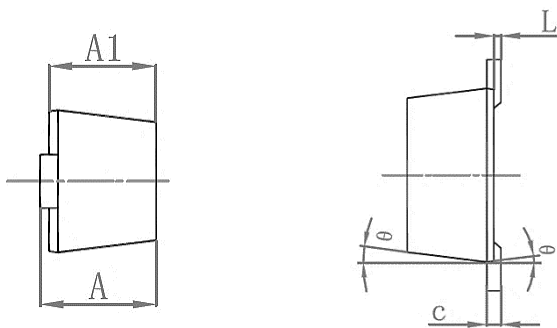
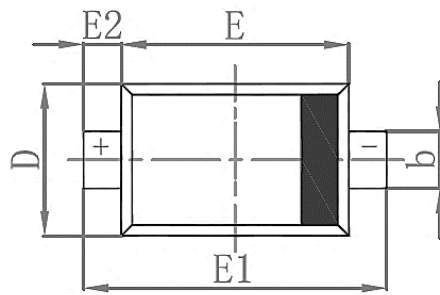

Symbol	Value ( mm )		
	Min.	Typ.	Max.
A	0.51		0.770
A1	0.50		0.70
b	0.250		0.350
c	0.080		0.150
D	0.750		0.850
E	1.10		1.30
E1	1.50		1.70
E2	0.20 Ref.		
L	0.010		0.070
K	7° Ref.		

**Recommend Pad Layout**

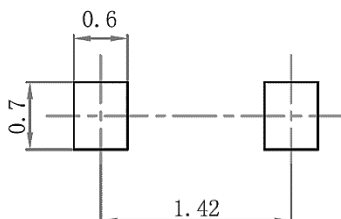

**Circuit Diagram**

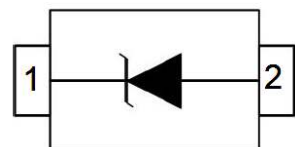

**SMD ESD PROTECTION DIODES SOD-523 SERIES**
**MECHANICAL DATA**

Case	Flammability Rating	Polarity	Mounting Position	Weight per piece
JEDEC SOT-523 molded plastic body	UL 94V - 0	-	-	-

**ABSOLUTE MAX. RATINGS AT Ta=25 °C (unless otherwise specified)**

Parameter	SYMBOLS	VALUE	UNITS
		LIMIT	
ESD per IEC 61000-4-2 (Air)	V ESD	+/-30	KV
ESD per IEC 61000-4-2 (Contact)	V ESD	+/-30	KV
ESD Voltage per human body model	ESD	16	KV
ESD Voltage per machine model	ESD	400	V
Total power dissipation on FR-5 Board (Note 1) @ Ta = 25°C	P D	150	mW
Operating Temperature Range	T J	-55 ~+ 150	°C
Storage Temperature Range	T STG	-55 ~ +150	°C
Lead Solder Temperature- Max. (10 s Duration)	T L	260 /10s	°C

Note: 1. FR-5=1.0x0.75x0.62 in.

**SMD ESD PROTECTION DIODES SOD-523 SERIES**
**ELECTRICAL CHARACTERISTICS ( Ta=25 °C unless otherwise specified)**

Parameter	SYMBOLS	VALUE			UNITS
		Min.	Typical	Max.	
Reverse Working Voltage	V <sub>RWM</sub>			15.0	V
Reverse Breakdown Voltage @ I <sub>T</sub> = 1.0mA	V <sub>BR</sub>	16.0			V
Reverse Leakage Current @V <sub>RWM</sub> = 15V, t <sub>p</sub> = 8/20μs	I <sub>R</sub>			0.50	μA
Clamping Voltage @ I <sub>PP</sub> = 5.0A, t <sub>p</sub> = 8/20μs	V <sub>C</sub>			23.0	V
Clamping Voltage @ I <sub>PP</sub> = 4.0A, t <sub>p</sub> = 8/20μs	V <sub>C</sub>			30.0	V
Peak Pulse Power per @ t <sub>p</sub> = 8/20μs	P <sub>PK</sub>			120	W
Junction Capacitance	C <sub>J</sub>			28	pF

**SMD ESD PROTECTION DIODES SOD-523 SERIES**
**RELIABILITY**

Number	Experiment Items	Experiment Method And Conditions	Reference Documents
1	Solder Resistance Test	Test 260°C± 5°C for 10 ± 2 sec. Immerse body into solder 1/16" ± 1/32"	MIL-STD-750D METHOD-2031.2
2	Solderability Test	230°C ±5°C for 5 sec.	MIL-STD-750D METHOD-2026.1 0
3	Pull Test	1 kg in axial lead direction for 10 sec.	MIL-STD-750D METHOD-2036.4
4	Bend Test	0.5Kg Weight Applied To Each Lead, Bending Arcs 90 °C ± 5 °C For 3 Times	MIL-STD-750D METHOD-2036.4
5	High Temperature Reverse Bias Test	TA=100°C for 1000 Hours at VR=80% Rated VR	MIL-STD-750D METHOD-1038.4
6	Forward Operation Life Test	TA=25°C Rated Average Rectified Current	MIL-STD-750D METHOD-1027.3
7	Intermittent Operation Life Test	On state: 5 min with rated IRMS Power Off state: 5 min with Cool Forced Air. On and off for 1000 cycles.	MIL-STD-750D METHOD-1036.3
8	Pressure Cooker Test	15 PSIG, TA=121°C, 4 hours	MIL-S-19500 APPENOIXC
9	Temperature Cycling Test	-55°C~+125°C; 30 Minutes For Dwelled Time 5 minutes for transferred time. Total: 10 cycles.	MIL-STD-750D METHOD-1051.7
10	Thermal Shock Test	0°C for 5 minutes., 100°C for 5minutes, Total: 10 cycles	MIL-STD-750D METHOD-1056.7
11	Forward Surge Test	8.3ms Single Sale Sine-wave One Surge.	MIL-STD-750D METHOD-4066.4
12	Humidity Test	TA=65°C, RH=98% for 1000 hours.	MIL-STD-750D METHOD-1021.3
13	High Temperature Storage life Test	150°C for 1000 Hours	MIL-STD-750D METHOD-1031.5

**SMD ESD PROTECTION DIODES SOD-523 SERIES**

**SUGGESTED REFLOW PROFILE (For Reference Only)**

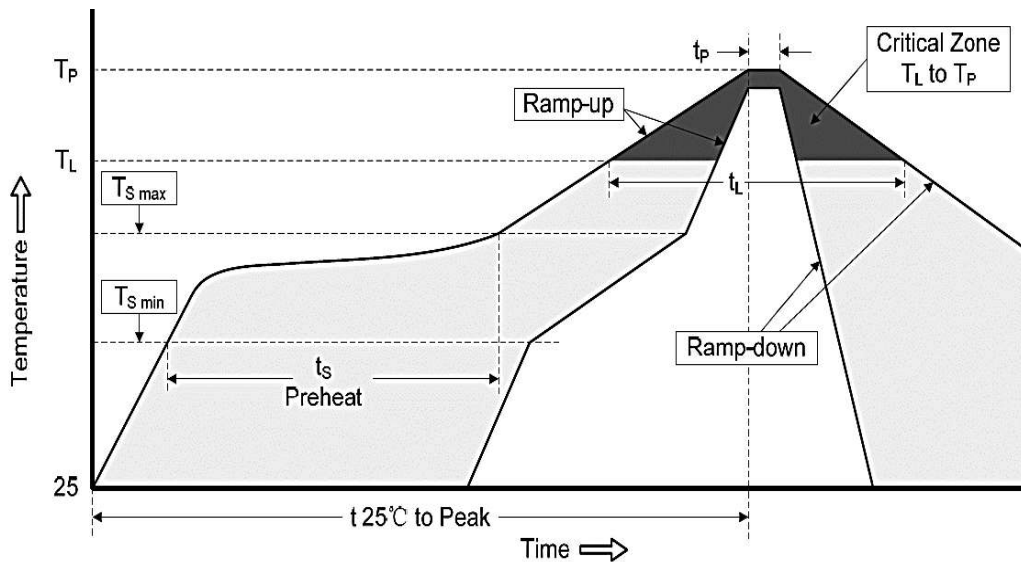

<b>Profile Feature</b>		Pb-Free Assembly
<b>Average Ramp-up Rate (Ts Max to Tp)</b>		3°C/second Max
<b>Preheat</b>	<b>Temperature Min (Ts Min.)</b>	150°C
	<b>Temperature Max (Ts Max.)</b>	200°C
	<b>Time (ts Min. to ts Max.)</b>	60 ~ 180 seconds
<b>Time maintained above</b>	<b>Temperature (Tl)</b>	217°C
	<b>Time (tl)</b>	60 ~ 150 seconds
<b>Peak/Classification Temperature (Tp)</b>		260 °C
<b>Time within 5°C of actual Peak Temperature (tp)</b>		20 ~ 40 seconds
<b>Ramp-down rate</b>		6 °C /Second Max.
<b>Time 25 °C to Peak Temperature</b>		8 minutes Max.
<b>Suggest reflow times</b>		3 Times Max.

**SMD ESD PROTECTION DIODES SOD-523 SERIES**

**RATINGS AND CHARACTERISTIC CURVES (For Reference Only)**

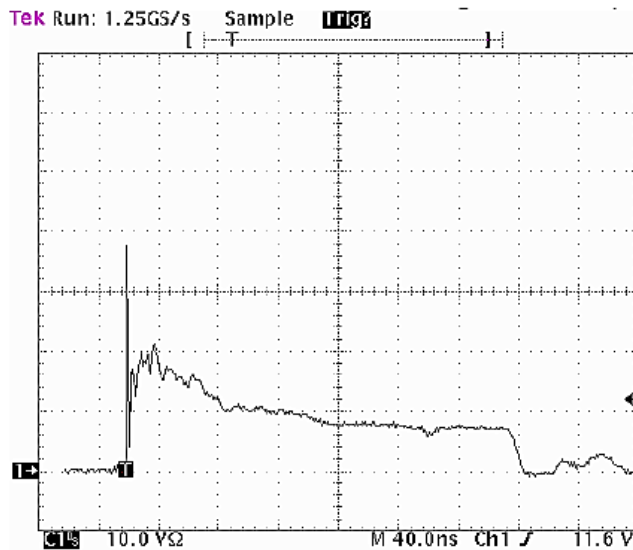

Figure 1. ESD Clamping Voltage Screenshot  
Positive 8 kV contact per IEC 61000-4-2

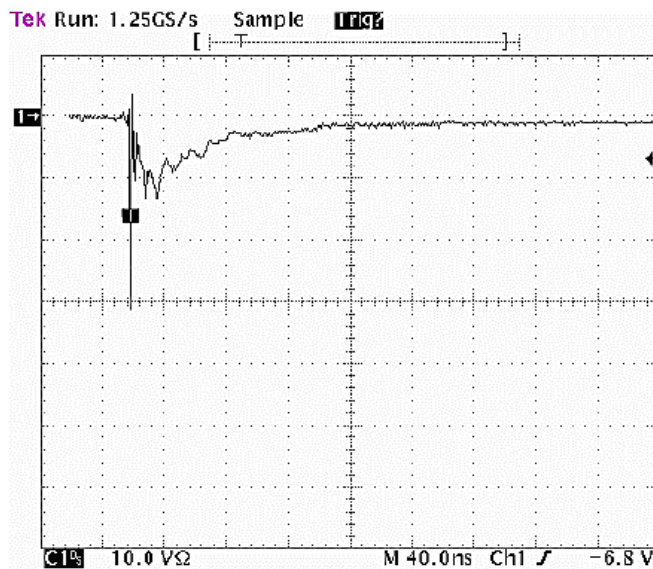

Figure 2. ESD Clamping Voltage Screenshot  
Negative 8 kV contact per IEC 61000-4-2



**SMD ESD PROTECTION DIODES SOD-523 SERIES**

**TAPE/REEL (Unit: mm)**

All Devices are packed in accordance with EIA standard RS-481-A and specifications.



Item	Symbol	Tolerance	SOD-523
Carrier width	A	0.1	2.10
Carrier Length	B	0.1	4.00
Carrier Depth	C	0.1	1.60
Sprocket hole	d	0.05	1.55
7" Reel outside diameter	D	2.0	178.00
7" Reel inner diameter	D1	Min.	50.00
Feed hole diameter	D2	0.5	13.00
Sprocket hole position	E	0.1	1.75
Punch hole position	F	0.1	3.50
Punch hole pitch	P	0.1	4.00
Sprocket hole pitch	P0	0.1	4.00
Embossment center	P1	0.1	2.00
Overall tape thickness	T	0.1	0.25
Tape width	W	0.3	8.15
Reel width	W1	1.0	10.50

**SMD ESD PROTECTION DIODES SOD-523 SERIES**

**SPQ PACKAGE for Reference**

Item	Unit	Value
Case Code		SOD-523
Reel Size	Inch	7
Reel Size	mm	178
Tape Space	mm	/
SPQ /Reel	pcs	3000
Weigh /SPQ	LBS	
Weigh /SPQ	KGs	
Qty. Per Box	pcs	6,000
Inner Box	Inch	L8.0*W8.0*H1.5

**DISCLAIMER**

NextGen Component, Inc. reserves the right to make changes to the product(s) and or information contained herein without notice. No liability is assumed as a result of their use or application. No rights under any patent accompany the sale of any such product(s) or information