

## Product Datasheet

### 330-8721-C

#### Dell® Compatible 10Gb/s SFP+ SR Transceiver

Hot Pluggable, Duplex LC, +3.3V, 850nm, VCSEL MMF 300m DDM

#### FEATURES

- Supports 9.95 to 11.3Gb/s bit rates
- Hot-Pluggable
- Duplex LC connector
- 850nm VCSEL transmitter, PIN photodetector
- MMF links up to 300m @ OM3 and 400m @ OM4
- 2-wire interface for management specifications compliant with SFF 8472 digital diagnostic monitoring interface
- Power Supply: +3.3V
- Power consumption < 1W
- Temperature Range: 0 ~ 70°C
- RoHS compliant

#### APPLICATIONS

- 10GBASE-SR/SW Ethernet
- SONET OC-192 / SDH
- 10G Fibre Channel

#### DESCRIPTION

ATGBICS® Compatible 330-8721-C Transceiver is a very compact 10Gb/s optical transceiver module for serial optical communication applications at 10Gb/s. The 330-8721-C converts a 10Gb/s serial electrical data stream to 10Gb/s optical output signal and a 10Gb/s optical input signal to 10Gb/s serial electrical data streams. The high speed 10Gb/s electrical interface is fully compliant with SFI specification.

The high performance 850nm VCSEL transmitter and high sensitivity PIN receiver provide superior performance for Ethernet applications at up to 300m links.

The SFP+ Module is compliant with SFF-8431, SFF-8432 and IEEE 802.3ae 10GBASE-SR. Digital diagnostics functions are available via a 2-wire serial interface, as specified in SFF-8472.

The fully SFP compliant form factor provides hot pluggability, easy optical port upgrades and low EMI emission.

## Product Datasheet

### Absolute Maximum Ratings

Parameter	Symbol	Min.	Typical	Max.	Unit
Storage Temperature	$T_s$	-40		+85	°C
Case Operating Temperature	$T_A$	0		70	°C
Maximum Supply Voltage	$V_{CC}$	-0.5		4	V
Relative Humidity	RH	0		85	%

### Electrical Characteristics ( $T_{OP} = 0$ to $70$ °C, $V_{CC} = 3.135$ to $3.465$ Volts)

Parameter	Symbol	Min.	Typical	Max.	Unit	Notes
Supply Voltage	$V_{CC}$	3.135		3.465	V	
Supply Current	$I_{CC}$			250	mA	
Power Consumption	P			1	W	
<b>Transmitter Section:</b>						
Input differential impedance	$R_{in}$		100		$\Omega$	1
Tx Input Single Ended DC Voltage Tolerance (Ref VeeT)	V	-0.3		4	V	
Differential input voltage swing	$V_{in,pp}$	180		700	mV	2
Transmit Disable Voltage	$V_D$	2		$V_{CC}$	V	3
Transmit Enable Voltage	$V_{EN}$	Vee		Vee+0.8	V	
<b>Receiver Section:</b>						
Single Ended Output Voltage Tolerance	V	-0.3		4	V	
Rx Output Diff Voltage	$V_o$	300		850	mV	
Rx Output Rise and Fall Time	$T_r/T_f$	30			ps	4
LOS Fault	$V_{LOS\ fault}$	2		$V_{CC\ HOST}$	V	5
LOS Normal	$V_{LOS\ norm}$	Vee		Vee+0.8	V	5

#### Notes:

1. Connected directly to TX data input pins. AC coupling from pins into laser driver IC.
2. Per SFF-8431 Rev 3.0
3. Into 100 ohms differential termination.
4. 20%~80%
5. LOS is an open collector output. Should be pulled up with 4.7k – 10k $\Omega$  on the host board. Normal operation is logic 0; loss of signal is logic 1. Maximum pull-up voltage is 5.5V.

## Product Datasheet

Optical Parameters ( $T_{OP} = 0$  to  $70^{\circ}\text{C}$ ,  $V_{CC} = 3.135$  to  $3.465$  Volts)

Parameter	Symbol	Min.	Typical	Max.	Unit	Notes
<b>Transmitter Section:</b>						
<b>Center Wavelength</b>	$\lambda_t$	840	850	860	nm	
<b>RMS spectral width</b>	$\lambda_{RMS}$			4	nm	
<b>Average Optical Power</b>	$P_{avg}$	-7.3		-1	dBm	1
<b>Optical Power OMA</b>	$P_{oma}$		-1.5		dBm	
<b>Laser Off Power</b>	$P_{off}$			-30	dBm	
<b>Extinction Ratio</b>	ER	3.5			dB	
<b>Transmitter Dispersion Penalty</b>	TDP			3.9	dB	2
<b>Relative Intensity Noise</b>	$R_{in}$			-128	dB/Hz	3
<b>Optical Return Loss Tolerance</b>		20			dB	
<b>Receiver Section:</b>						
<b>Center Wavelength</b>	$\lambda_r$	840		860	nm	
<b>Receiver Sensitivity (OMA)</b>	$S_{en}$			-11.1	dBm	4
<b>Stressed Sensitivity (OMA)</b>	$S_{en_{ST}}$			-7.5	dBm	4
<b>Los Assert</b>	$LOS_A$	-30		-	dBm	
<b>Los Dessert</b>	$LOS_D$			-12	dBm	
<b>Los Hysteresis</b>	$LOS_H$	0.5			dB	
<b>Overload</b>	Sat	0			dBm	5
<b>Receiver Reflectance</b>	$R_{rx}$			-12	dB	

Notes:

1. Average power figures are informative only, per IEEE802.3ae.
2. TWDP figure requires the host board to be SFF-8431 compliant. TWDP is calculated using the Matlab code provided in clause 68.6.6.2 of IEEE802.3ae.
3. 12dB reflection.
4. Conditions of stressed receiver tests per IEEE802.3ae. CSRS testing requires the host board to be SFF-8431 compliant.
5. Receiver overload specified in OMA and under the worst comprehensive stressed condition.

## Product Datasheet

### Timing Characteristics

Parameter	Symbol	Min.	Typical	Max.	Unit
TX_Disable Assert Time	t_off			10	us
TX_Disable Negate Time	t_on			1	ms
Time to Initialize Include Reset of TX_FAULT	t_int			300	ms
TX_FAULT from Fault to Assertion	t_fault			100	us
TX_Disable Time to Start Reset	t_reset	10			us
Receiver Loss of Signal Assert Time	T <sub>A,RX_LOS</sub>			100	us
Receiver Loss of Signal Deassert Time	T <sub>d,RX_LOS</sub>			100	us
Rate-Select Change Time	t_ratesel			10	us
Serial ID Clock Time	t_serial-clock			100	kHz

### Pin Assignment

Diagram of Host Board Connector Block Pin Numbers and Name



## Product Datasheet

### Pin Function Definitions

PIN No	Name	Function	Notes
1	VeeT	Module transmitter ground	1
2	Tx Fault	Module transmitter fault	2
3	Tx Disable	Transmitter Disable; Turns off transmitter laser output	3
4	SDL	2 wire serial interface data input/output (SDA)	
5	SCL	2 wire serial interface clock input (SCL)	
6	MOD-ABS	Module Absent, connect to VeeR or VeeT in the module	2
7	RS0	Rate select0, optionally control SFP+ receiver. When high, input data rate >4.5Gb/s; when low, input data rate <=4.5Gb/s	
8	LOS	Receiver Loss of Signal Indication	4
9	RS1	Rate select0, optionally control SFP+ transmitter. When high, input data rate >4.5Gb/s; when low, input data rate <=4.5Gb/s	
10	VeeR	Module receiver ground	1
11	VeeR	Module receiver ground	1
12	RD-	Receiver inverted data out put	
13	RD+	Receiver non-inverted data out put	
14	VeeR	Module receiver ground	1
15	VccR	Module receiver 3.3V supply	
16	VccT	Module transmitter 3.3V supply	
17	VeeT	Module transmitter ground	1
18	TD+	Transmitter inverted data out put	
19	TD-	Transmitter non-inverted data out put	
20	VeeT	Module transmitter ground	1

#### Notes:

1. The module ground pins are isolated from the module case.
2. This pin is an open collector/drain output pin and is pulled up with 4.7K-10Kohms to Host\_Vcc on the host board.
3. This pin is pulled up with 4.7K-10Kohms to VccT in the module.
4. This pin is an open collector/drain output pin and is pulled up with 4.7K-10Kohms to Host\_Vcc on the host board.

## Product Datasheet

### SFP Module EEPROM Information and Management

The SFP modules implement the 2-wire serial communication protocol as defined in the SFP -8472. The serial ID information of the SFP modules and Digital Diagnostic Monitor parameters can be accessed through the I<sup>2</sup>C interface at address A0h and A2h. The memory is mapped in Table 1. Detailed ID information (A0h) is listed in Table 2. And the DDM specification at address A2h. For more details of the memory map and byte definitions, please refer to the SFF-8472, "Digital Diagnostic Monitoring Interface for Optical Transceivers". The DDM parameters have been internally calibrated.

Table 1 - Digital Diagnostic Memory Map (Specific Data Field Descriptions)

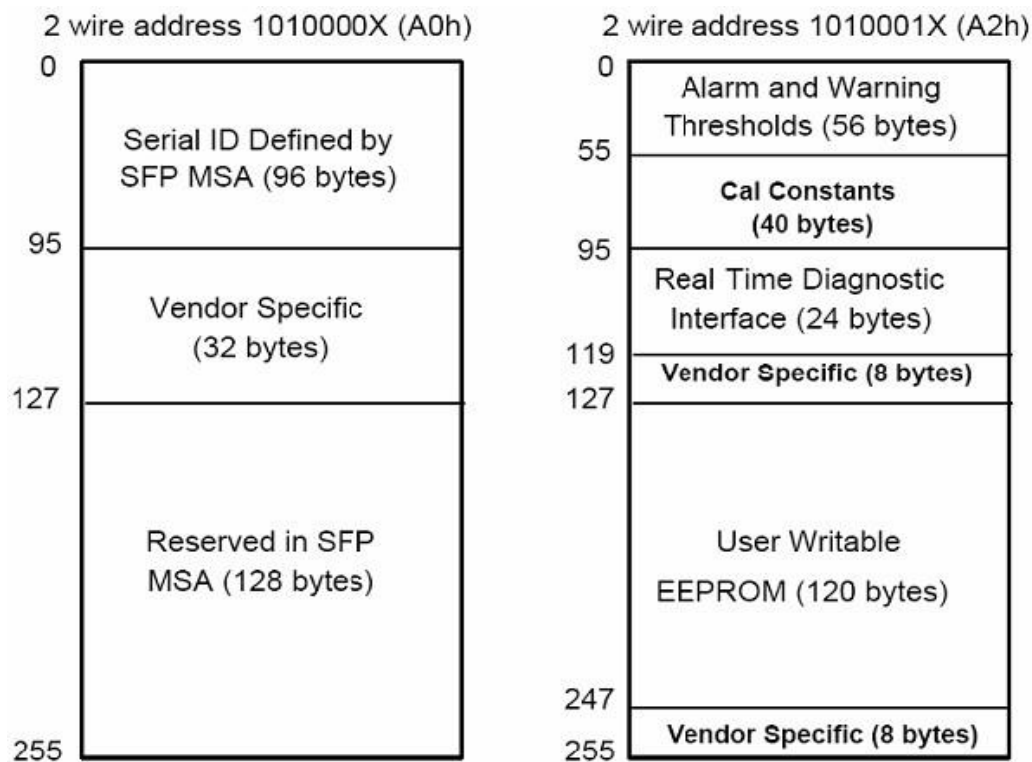

## Product Datasheet

Table 2 - EEPROM Serial ID Memory Contents (A0h)

Data Address	Length (Byte)	Name of Length	Description and Contents
<b>Base ID Fields</b>			
0	1	Identifier	Type of Serial transceiver (03h=SFP)
1	1	Reserved	Extended identifier of type serial transceiver (04h)
2	1	Connector	Code of optical connector type (07=LC)
3-10	8	Transceiver	10G Base-SR
11	1	Encoding	64B/66B
12	1	BR, Nominal	Nominal baud rate, unit of 100Mbps
13-14	2	Reserved	(0000h)
15	1	Length(9um)	Link length supported for 9/125um fibre, units of 100m
16	1	Length(50um)	Link length supported for 50/125um fibre, units of 10m
17	1	Length(62.5um)	Link length supported for 62.5/125um fibre, units of 10m
18	1	Length(Copper)	Link length supported for copper, units of meters
19	1	Reserved	
20-35	16	Vendor Name	SFP vendor name: ATGBICS
36	1	Reserved	
37-39	3	Vendor OUI	SFP transceiver vendor OUI ID
40-55	16	Vendor PN	Part Number: "330-8721-C" (ASCII)
56-59	4	Vendor rev	Revision level for part number
60-62	3	Reserved	
63	1	CCID	Least significant byte of sum of data in address 0-62
<b>Extended ID Fields</b>			
64-65	2	Option	Indicates which optical SFP signals are implemented (001Ah = LOS, TX_FAULT, TX_DISABLE all supported)
66	1	BR, max	Upper bit rate margin, units of %
67	1	BR, min	Lower bit rate margin, units of %
68-83	16	Vendor SN	Serial number (ASCII)
84-91	8	Date code	OEM's Manufacturing date code
92-94	3	Reserved	
95	1	CCEX	Check code for the extended ID Fields (addresses 64 to 94)
<b>Vendor Specific ID Fields</b>			

## Product Datasheet

<b>96-127</b>	32	Readable	OEM specific date, read only
<b>128-255</b>	128	Reserved	Reserved for SFF-8079

### Digital Diagnostic Monitor Characteristics

Data Address	Parameter	Accuracy	Unit
<b>96-97</b>	Transceiver Internal Temperature	±3.0	°C
<b>98-99</b>	VCC3 Internal Supply Voltage	±3.0	%
<b>100-101</b>	Laser Bias Current	±10	%
<b>102-103</b>	Tx Output Power	±3.0	dBm
<b>104-105</b>	Rx Input Power	±3.0	dBm

### Regulatory Compliance

The 330-8721-C complies with international Electromagnetic Compatibility (EMC) and international safety requirements and standards (see details in Table following).

Electrostatic Discharge (ESD) to the Electrical Pins	MIL-STD-883E Method 3015.7	Class 1(>1000 V)
Electrostatic Discharge (ESD) to the Duplex LC Receptacle	IEC 61000-4-2 GR-1089-CORE	Compatible with standards
Electromagnetic Interference (EMI)	FCC Part 15 Class B EN55022 Class B (CISPR 22B) VCCI Class B	Compatible with standards
Laser Eye Safety	FDA 21CFR 1040.10 and 1040.11 EN60950, EN (IEC) 60825-1,2	Compatible with Class 1 laser product.



## Product Datasheet

### Recommended Circuit

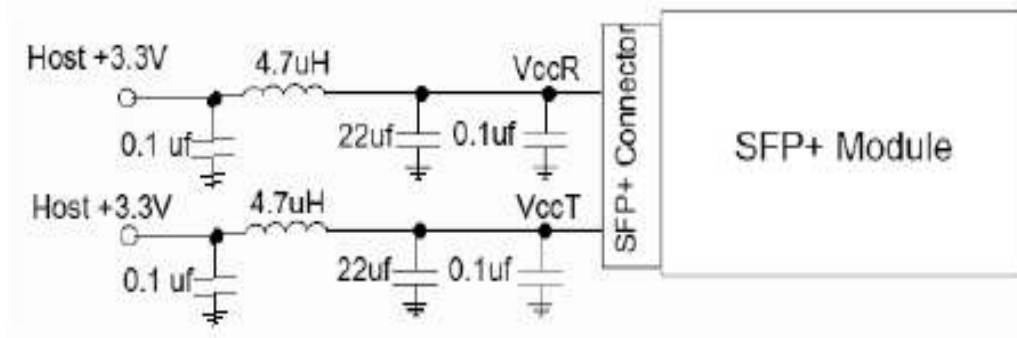

**Recommended Host Board Power Supply Circuit**



**Recommended High-speed Interface Circuit**

## Product Datasheet

### Mechanical Dimensions

