

# MGA-43628

## High Linearity (2.0 – 2.2) GHz Power Amplifier Module



### Data Sheet

#### Description

Avago Technologies' MGA-43628 is a fully matched power amplifier for use in the (2.0-2.2) GHz band. High linear output power at 5 V is achieved through the use of Avago Technologies' proprietary 0.25  $\mu\text{m}$  GaAs Enhancement-mode pHEMT process. MGA-43628 is housed in a miniature 5.0 mm x 5.0 mm molded-chip-on-board (MCOB) module package. A detector is also included on-chip. The compact footprint coupled with high gain, high linearity and good efficiency makes the MGA-43628 an ideal choice as a power amplifier for small cell BTS PA applications.

#### Applications

- Final stage high linearity amplifier for Picocell and Enterprise Femtocell PA targeted for small cell BTS downlink applications.

#### Component Image

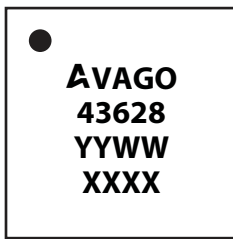

TOP VIEW

#### 5.0 x 5.0 x 0.9 mm Package Outline

Note:  
Package marking provides orientation and identification  
"43628" = Device part number  
"YYWW" = year and work week  
"XXXX" = assembly lot number

#### Pin Configuration

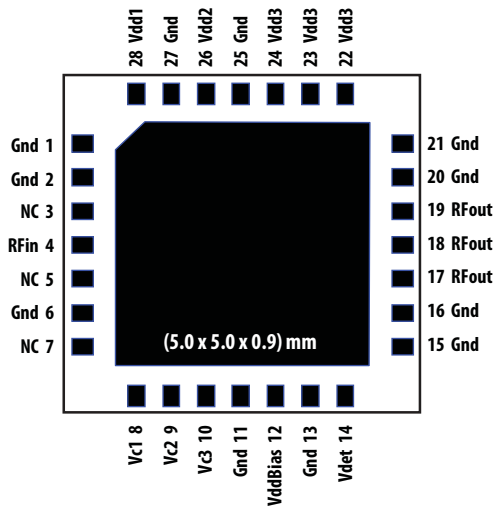

#### Features

- High linearity performance: Typ -50 dBc ACLR1<sup>[1]</sup> at 27.2 dBm linear output power (biased with 5.0 V operating voltage)
- High Gain: 41.5 dB
- Good efficiency
- Fully matched
- Built-in detector
- GaAs E-pHEMT Technology<sup>[2]</sup>
- Low cost small package size: 5.0 x 5.0 x 0.9 mm
- MSL3
- Lead free/Halogen free RoHS compliance

#### Specifications

2.14 GHz; 5.0 V, Idqtotal = 440 mA (typ), W-CDMA Test model #1, 64 DPCH downlink signal

- PAE: 14%
- 27.2 dBm linear Pout @ ACLR1 = -50 dBc<sup>[1]</sup>
- 41.5 dB Gain
- Detector range: 20 dB

Note:

- W-CDMA Test model #1, 64DPCH downlink signal.
- Enhancement mode technology employs positive Vgs, thereby eliminating the need of negative gate voltage associated with conventional depletion mode devices.

#### Functional Block Diagram

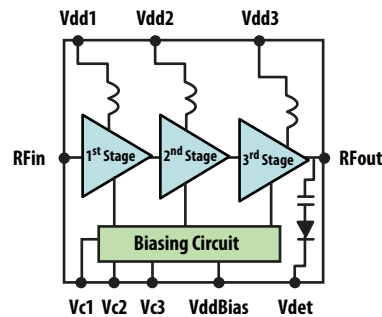

**Attention: Observe precautions for handling electrostatic sensitive devices.**

ESD Machine Model = 60 V  
ESD Human Body Model = 450 V  
Refer to Avago Application Note A004R:  
Electrostatic Discharge, Damage and Control.

**Absolute Maximum Rating**<sup>[1]</sup>  $T_A = 25^\circ\text{C}$ 

Symbol	Parameter	Units	Absolute Max.
Vdd, VddBias	Supply voltages, bias supply voltage	V	6
Vc	Control Voltage	V	(Vdd)
P <sub>in,max</sub>	CW RF Input Power	dBm	20
P <sub>diss</sub>	Total Power Dissipation <sup>[3]</sup>	W	7.2
T <sub>j</sub>	Junction Temperature	°C	150
T <sub>STG</sub>	Storage Temperature	°C	-65 to 150

**Thermal Resistance**<sup>[2,3]</sup>

$\theta_{jC} = 13^\circ\text{C/W}$

Notes:

1. Operation of this device in excess of any of these limits may cause permanent damage.
2. Thermal resistance measured using Infra-Red Measurement Technique at Vdd = 5.5 V operating voltage.
3. Board temperature (TB) is 25° C, for TB > 56.4° C derate the device power at 77 mW per °C rise in Board (package belly) temperature.

**Electrical Specifications**

$T_A = 25^\circ\text{C}$ , Vdd = VddBias = 5.0 V, Vc1=2.4V, Vc2=1.6V, Vc3=2.2V, Idqtotal = 440 mA, RF performance at 2.14 GHz, W-CDMA Test model #1, 64DPCH downlink signal operation unless otherwise stated.

Symbol	Parameter and Test Condition	Units	Min.	Typ.	Max.
Vdd	Supply Voltage	V		5.0	
Idqtotal	Quiescent Supply Current	mA		440	600
Gain	Gain	dB	38	41.5	
OP1dB	Output Power at 1dB Gain Compression	dBm		36.8	
ACLR1 @ Pout = 27.2 dBm	W-CDMA Test model #1, 64DPCH downlink signal	dBc		-50	
PAE @ Pout = 27.2 dBm	Power Added Efficiency	%	11.5	14	
S11	Input Return Loss, 50 $\Omega$ source	dB		15.8	
DetR	Detector RF dynamic range	dB		20	

$T_A = 25^\circ\text{C}$ , Vdd = VddBias = 5.5 V, Vc1=2.4V, Vc2=1.6V, Vc3=2.2V, Idqtotal = 490 mA, RF performance at 2.14 GHz, W-CDMA Test model #1, 64DPCH downlink signal operation unless otherwise stated.

Symbol	Parameter and Test Condition	Units	Typ.
Vdd	Supply Voltage	V	5.5
Idqtotal	Quiescent Supply Current	mA	490
Gain	Gain	dB	41.5
OP1dB	Output Power at 1dB Gain Compression	dBm	37.6
ACLR1 @ Pout = 27.9 dBm	W-CDMA Test model #1, 64DPCH downlink signal	dBc	-50
PAE @ Pout = 27.9 dBm	Power Added Efficiency	%	13.2
S11	Input Return Loss, 50 $\Omega$ source	dB	16.1
DetR	Detector RF dynamic range	dB	20

## Product Consistency Distribution Charts [4]

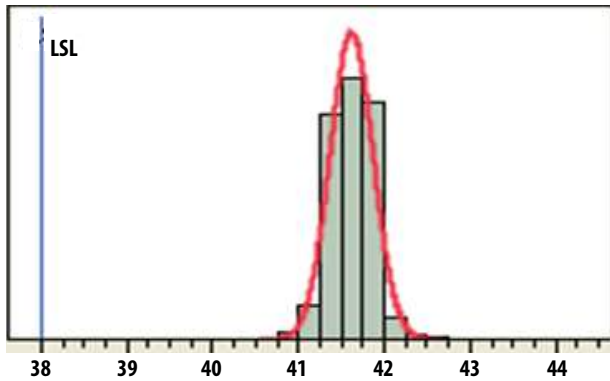

Figure 1. Gain at Pout=27.2dBm; LSL=38dB, Nominal = 41.5dB

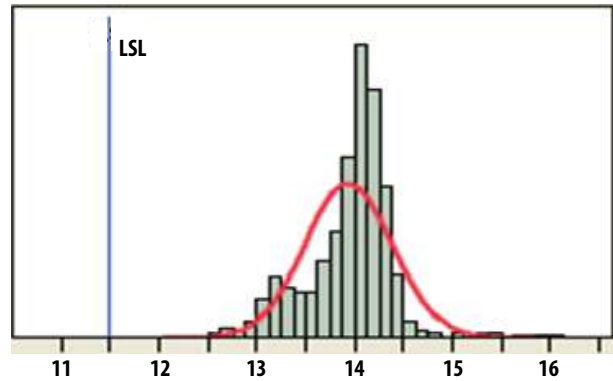

Figure 2. PAE at Pout=27.2dBm; LSL=11.5%, Nominal = 14%

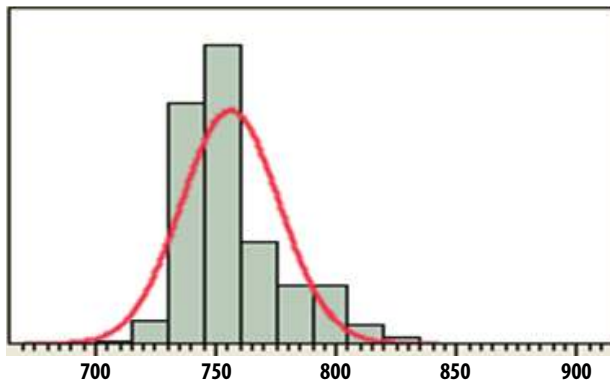

Figure 3. Idd\_Total at Pout = 27.2 dBm, Nominal = 750 mA

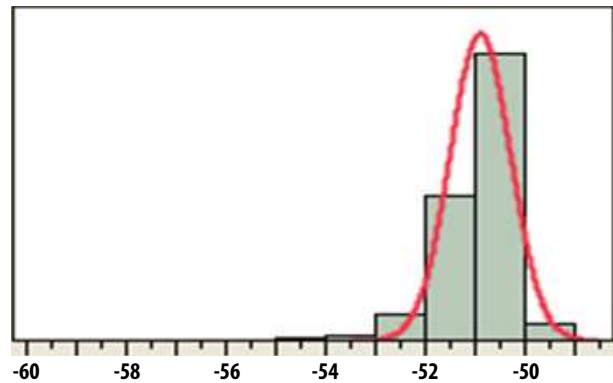

Figure 4. ACLR1 at Pout = 27.2 dBm, Nominal = -50.8 dBc

Note:

- Distribution data sample size is 1500 samples taken from 3 different wafer lots.  $T_A = 25^\circ\text{C}$ ,  $V_{dd} = V_{ddBias} = 5.0\text{V}$ ,  $V_{c1} = 2.4\text{V}$ ,  $V_{c2} = 1.6\text{V}$ ,  $V_{c3} = 2.2\text{V}$ , RF performance at 2.14 GHz unless otherwise stated. Future wafers allocated to this product may have nominal values anywhere between the upper and lower limits.

MGA-43628 typical over-temperature performance at  $V_{c1} = 2.4\text{ V}$ ,  $V_{c2} = 1.6\text{ V}$ ,  $V_{c3} = 2.2\text{ V}$  as shown in Figure 30 unless otherwise stated

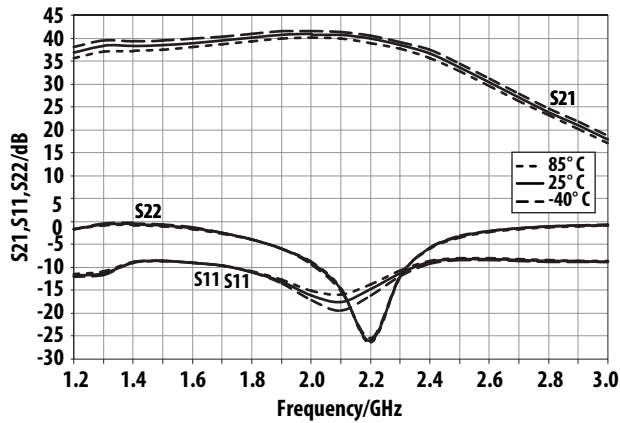

Figure 5. Small-signal performance Over-temperature  
 $V_{dd} = V_{ddBias} = 5.0\text{ V}$  operating voltage

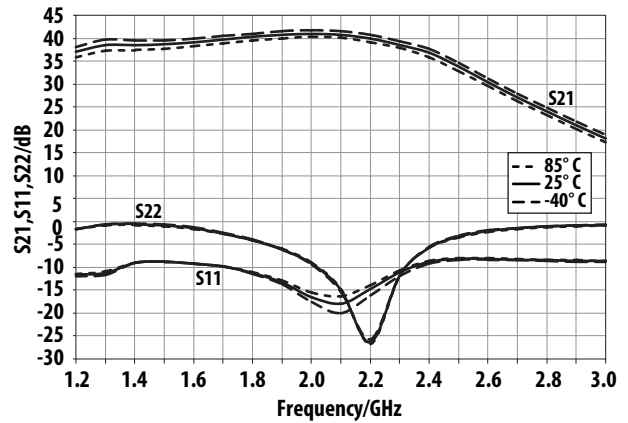

Figure 6. Small-signal performance Over-temperature  
 $V_{dd} = V_{ddBias} = 5.5\text{ V}$  operating voltage

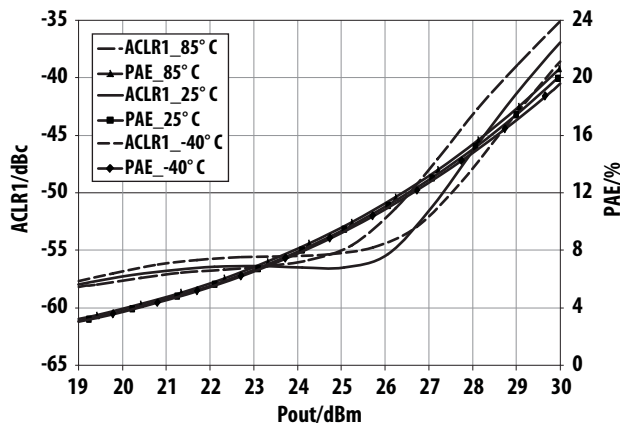

Figure 7. Over-temperature ACLR1, PAE vs Pout @ 2.11 GHz  
 $V_{dd} = V_{ddBias} = 5.0\text{ V}$  operating voltage

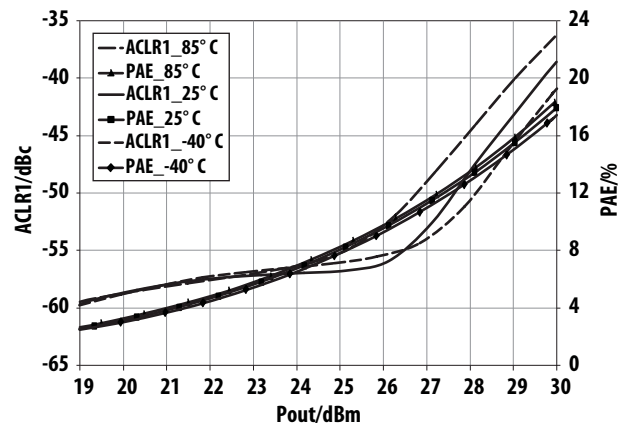

Figure 8. Over-temperature ACLR1, PAE vs Pout @ 2.11 GHz  
 $V_{dd} = V_{ddBias} = 5.5\text{ V}$  operating voltage

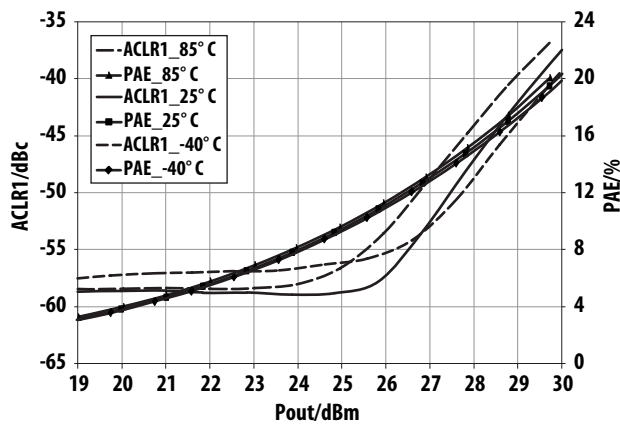

Figure 9. Over-temperature ACLR1, PAE vs Pout @ 2.14 GHz  
 $V_{dd} = V_{ddBias} = 5.0\text{ V}$  operating voltage

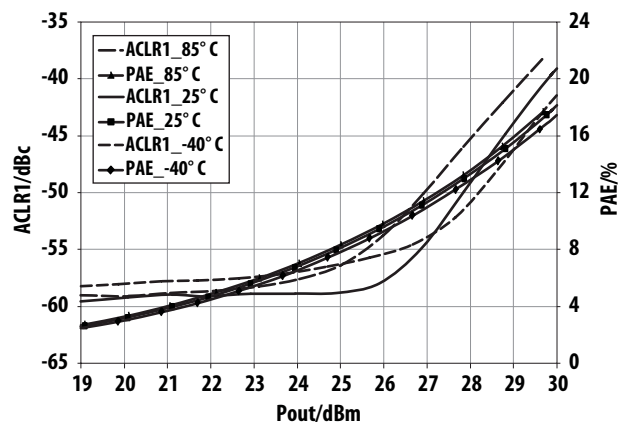

Figure 10. Over-temperature ACLR1, PAE vs Pout @ 2.14 GHz  
 $V_{dd} = V_{ddBias} = 5.5\text{ V}$  operating voltage

**MGA-43628 typical over-temperature performance at  $V_{c1} = 2.4\text{ V}$ ,  $V_{c2} = 1.6\text{ V}$ ,  $V_{c3} = 2.2\text{ V}$  unless otherwise stated**

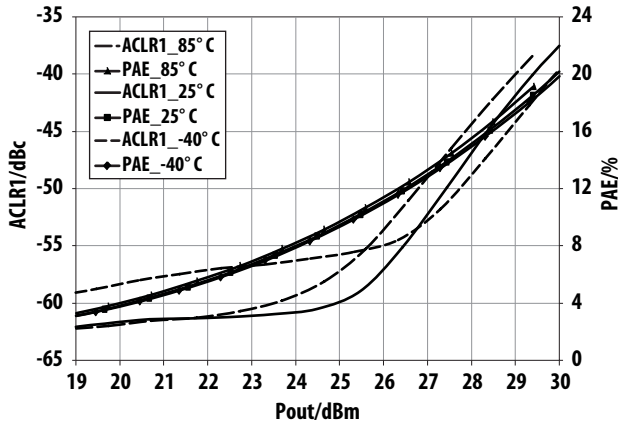

Figure 11. Over-temperature ACLR1, PAE vs Pout @ 2.17 GHz  
Vdd = VddBias = 5.0 V operating voltage

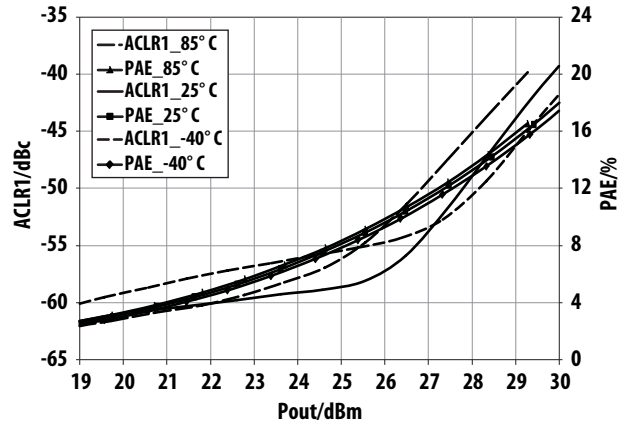

Figure 12. Over-temperature ACLR1, PAE vs Pout @ 2.17 GHz  
Vdd = VddBias = 5.5 V operating voltage

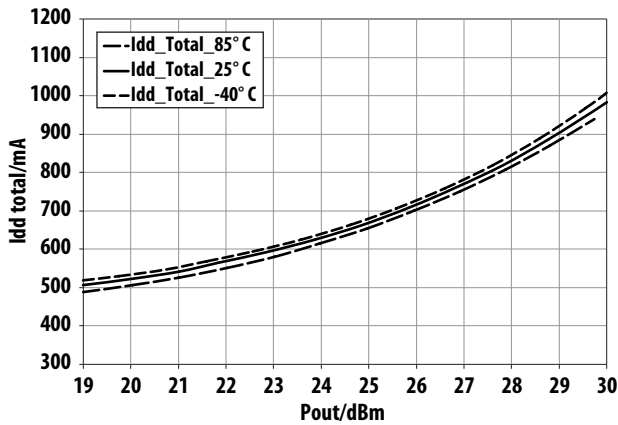

Figure 13. Over-temperature Idd\_Total vs Pout @ 2.14 GHz  
Vdd = VddBias = 5.0 V operating voltage

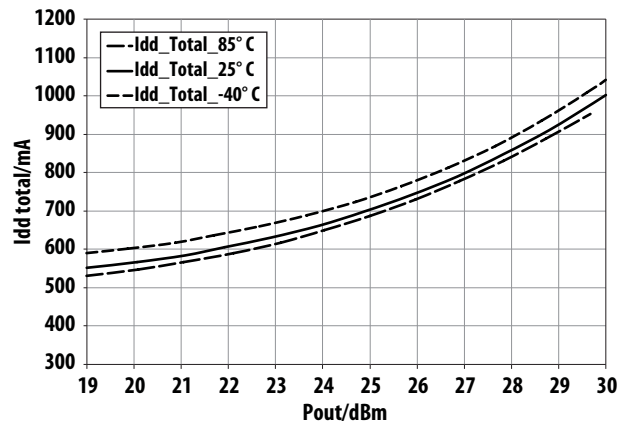

Figure 14. Over-temperature Idd\_Total vs Pout @ 2.14 GHz  
Vdd = VddBias = 5.5 V operating voltage

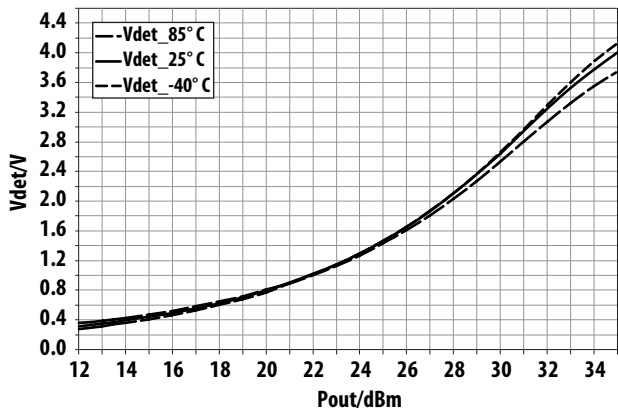

Figure 15. Over-temperature Vdet vs Pout @ 2.14 GHz  
Vdd = VddBias = 5.0 V operating voltage

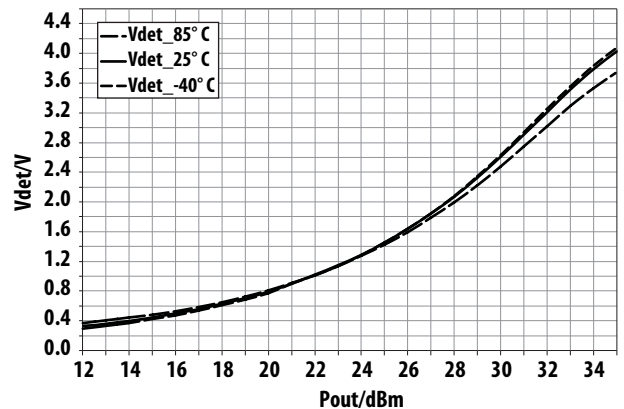

Figure 16. Over-temperature Vdet vs Pout @ 2.14 GHz  
Vdd = VddBias = 5.5 V operating voltage

MGA-43628 typical over-temperature performance at  $V_{c1} = 2.4\text{ V}$ ,  $V_{c2} = 1.6\text{ V}$ ,  $V_{c3} = 2.2\text{ V}$  unless otherwise stated

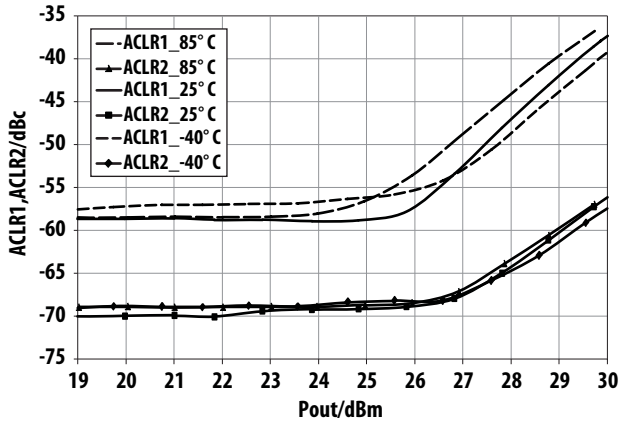

Figure 17. Over-temperature ACLR1, ACLR2 Pout @ 2.14 GHz  
Vdd = VddBias = 5.0 V operating voltage

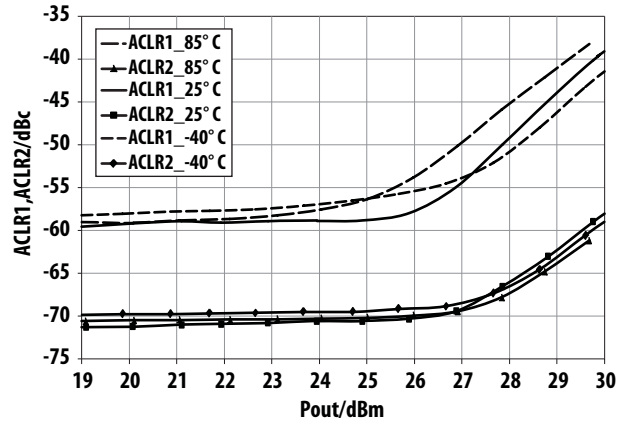

Figure 18. Over-temperature ACLR1, ACLR2 vs Pout @ 2.14 GHz  
Vdd = VddBias = 5.5 V operating voltage

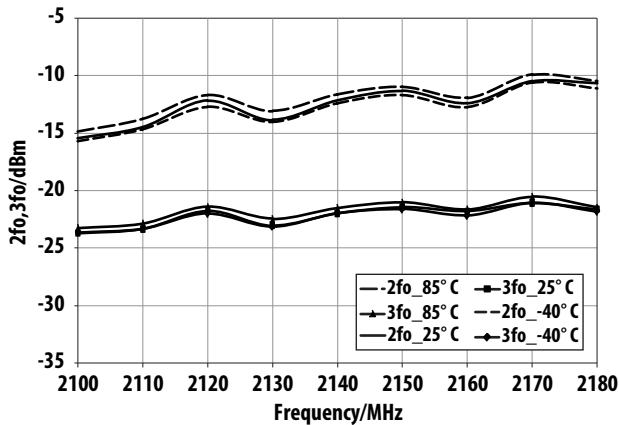

Figure 19. Over-temperature 2nd, 3rd Harmonics vs Freq at Pout = 27.2 dBm,  
Vdd = VddBias = 5.0 V operating voltage

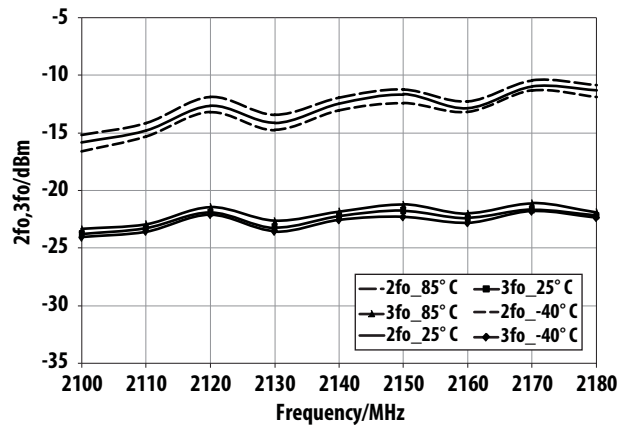

Figure 20. Over-temperature 2nd, 3rd Harmonics vs Freq at Pout = 27.2 dBm,  
Vdd = VddBias = 5.5 V operating voltage

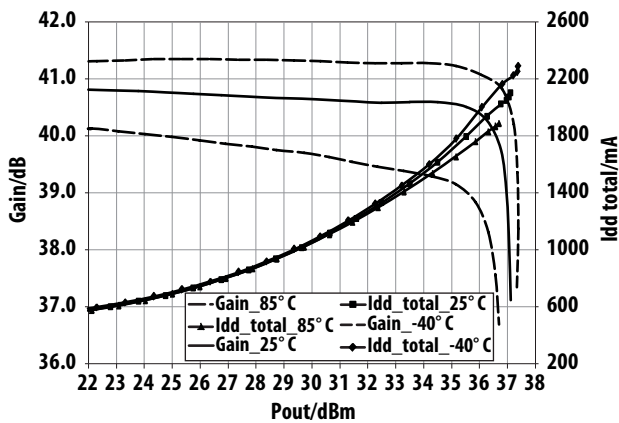

Figure 21. Over-temperature Gain, Idd\_total vs Pout @ 2.14 GHz  
Vdd = VddBias = 5.0 V operating voltage

**MGA-43628 typical over-temperature performance at Vc1 = 2.4 V, Vc2 = 1.6 V, Vc3 = 2.2 V unless otherwise stated**

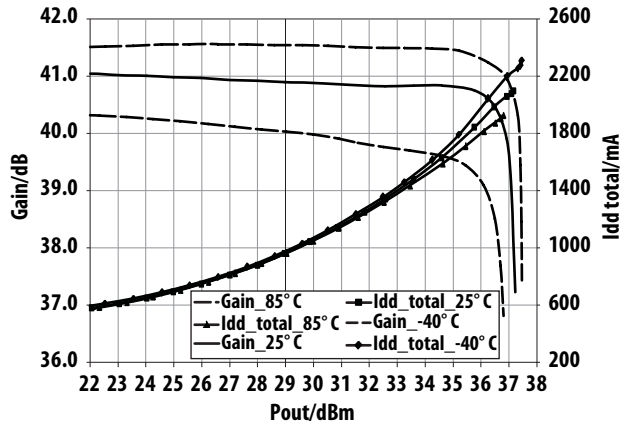

Figure 22. Over-temperature Gain, Idd\_total vs Pout @ 2.11 GHz  
Vdd = VddBias = 5.0 V operating voltage

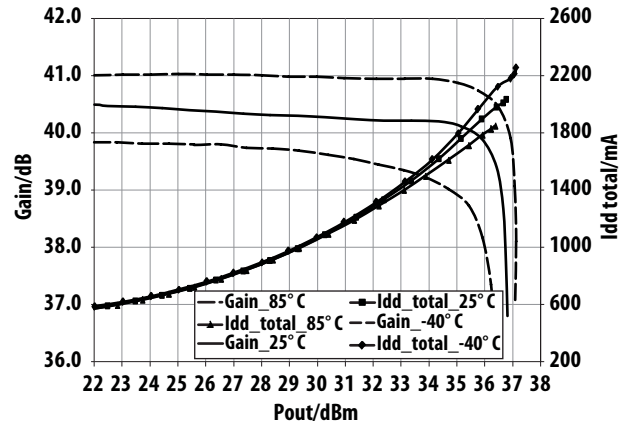

Figure 23. Over-temperature Gain, Idd\_total vs Pout @ 2.17 GHz  
Vdd = VddBias = 5.0 V operating voltage

**MGA-43628 typical 3GPP W-CDMA Test model #1 Spectrum Emission Mask performance at Vdd = VddBias = 5.0 V, Vc1 = 2.4 V, Vc2 = 1.6 V, Vc3 = 2.2 V unless otherwise stated**

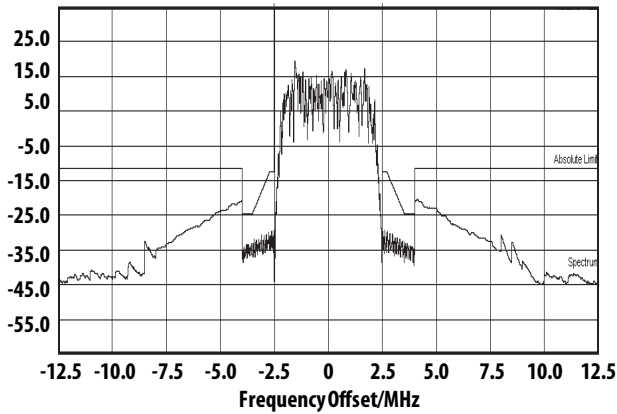

Figure 24. SEM at Pout = 28 dBm @ 2.11 GHz

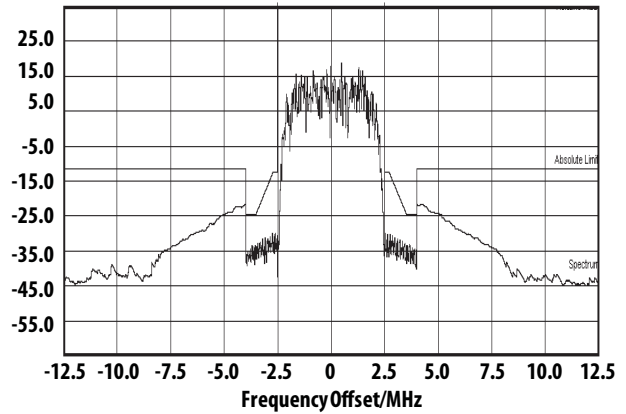

Figure 25. SEM at Pout = 28 dBm @ 2.14 GHz

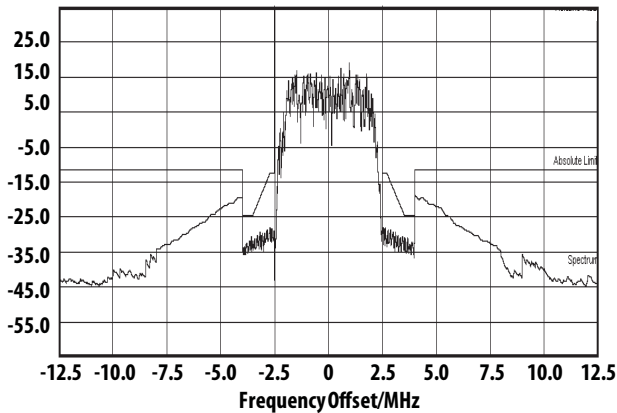

Figure 26. SEM at Pout = 28 dBm @ 2.17 GHz

**MGA-43628 typical LTE Downlink (E-TM1.1) 10 MHz 50RB performance at Vdd = VddBias = 5.0 V, Vc1 = 2.2 V, Vc2 = 1.6 V, Vc3 = 2.0 V unless otherwise stated**

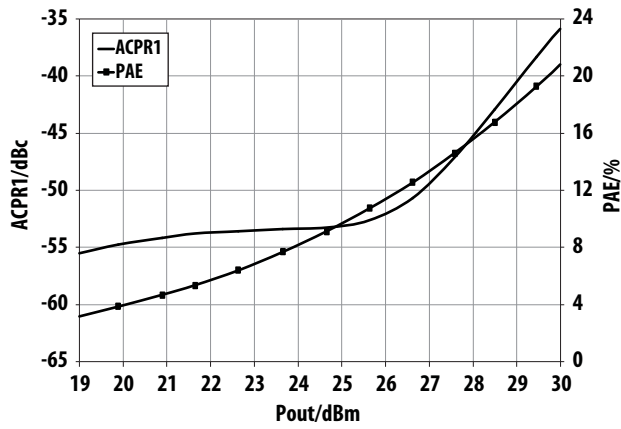

Figure 27. ACPR1, PAE vs Pout @ 2.11 GHz

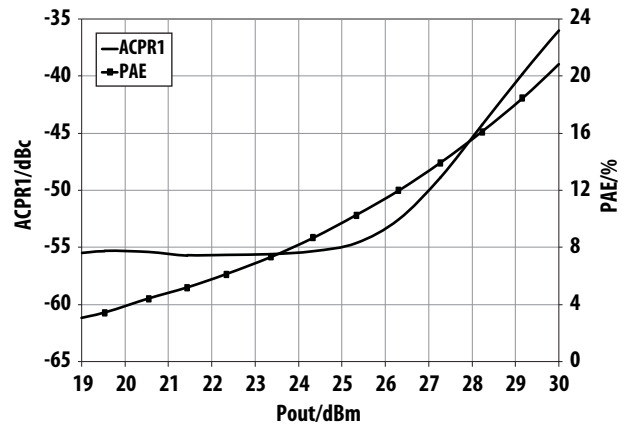

Figure 28. ACPR1, PAE vs Pout @ 2.14 GHz

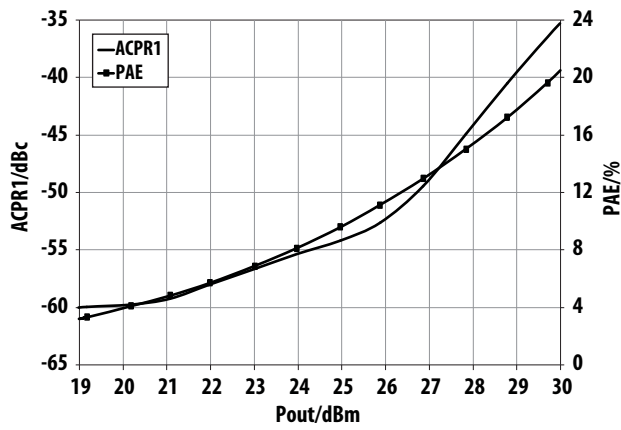

Figure 29. ACPR1, PAE vs Pout @ 2.17 GHz



**S-Parameter<sup>[5]</sup> (Vdd = VddBias = 5.0 V, Vc1 = 2.4 V, Vc2 = 1.6 V, Vc3 = 2.2 V, TA = 25° C, 50ohm)**

Freq (GHz)	S11 (dB)	S11 (ang)	S21 (dB)	S21 (ang)	S12 (dB)	S12 (ang)	S22 (dB)	S22 (ang)
0.1	-0.30	175.06	-57.18	-39.10	-61.12	-112.05	-0.58	175.26
0.2	-0.35	164.36	-52.55	-85.61	-60.63	41.83	-0.92	173.40
0.3	-0.38	154.98	-43.76	-73.69	-63.55	2.56	-1.12	172.26
0.4	-0.37	145.35	-28.46	-63.76	-66.27	12.15	-1.23	171.46
0.5	-0.95	135.17	-14.76	-162.07	-64.90	-2.49	-1.26	171.49
0.6	-0.71	125.36	-15.52	-98.77	-64.53	9.15	-0.98	167.57
0.7	-0.71	110.04	3.08	-114.53	-63.24	122.31	-1.43	165.91
0.8	-2.40	80.38	18.79	33.00	-64.55	105.07	-1.65	165.48
0.9	-5.66	100.45	21.40	65.15	-63.61	117.52	-1.87	165.69
1.0	-3.66	83.17	12.70	19.21	-65.73	73.37	-1.60	167.15
1.1	-3.96	48.86	23.94	84.77	-65.29	57.70	-2.60	166.85
1.2	-15.39	24.98	34.54	26.80	-62.86	83.98	-1.00	166.58
1.3	-10.88	62.04	36.69	-45.42	-64.73	78.44	-0.50	161.28
1.4	-9.98	35.77	37.12	-92.22	-63.37	84.70	-0.44	155.07
1.5	-10.60	6.13	37.64	-129.25	-61.88	85.23	-0.65	148.97
1.6	-11.17	-26.64	38.37	-162.53	-61.45	89.51	-1.08	142.44
1.7	-11.06	-63.12	39.17	164.66	-58.50	93.36	-1.92	136.10
1.8	-10.93	-95.47	40.04	131.88	-56.84	93.39	-3.06	129.46
1.9	-11.16	-123.23	40.80	96.99	-54.06	67.27	-4.93	122.82
2.0	-13.07	-140.18	41.05	60.01	-53.63	53.98	-7.77	118.32
2.1	-15.03	-131.53	40.67	21.57	-52.49	38.60	-12.94	117.59
2.2	-11.88	-115.12	39.82	-11.45	-53.38	22.51	-22.70	-83.11
2.3	-8.23	-127.01	38.74	-52.24	-51.99	4.48	-8.54	-123.11
2.4	-6.74	-145.02	36.01	-89.38	-54.52	-15.90	-4.13	-138.34
2.5	-6.53	-159.78	32.66	-118.56	-57.12	-30.73	-2.27	-150.84
2.6	-6.71	-170.51	29.37	-141.53	-57.17	-23.86	-1.39	-160.05
2.7	-7.10	-106.47	26.22	-161.19	-60.58	-29.76	-0.93	-166.90
2.8	-7.53	175.59	23.23	-178.10	-60.20	-33.50	-0.67	-172.14
2.9	-7.87	171.12	20.39	166.93	-63.97	-48.10	-0.50	-176.37
3.0	-8.18	167.41	17.69	153.18	-63.52	-47.65	-0.39	-35.98
3.1	-8.42	164.27	15.05	140.45	-65.05	-29.66	-0.31	176.88
3.2	-8.62	161.29	12.44	128.26	-67.98	44.67	-0.26	173.94
3.3	-8.79	158.64	9.75	116.69	-66.94	56.68	-0.23	171.25
3.4	-8.93	156.09	6.99	105.56	-65.82	46.96	-0.21	168.65
3.5	-9.03	153.75	3.97	94.82	-67.24	-32.48	-0.19	166.15
3.6	-9.12	151.35	0.44	84.83	-66.22	80.49	-0.18	163.60
3.7	-9.19	149.35	-4.16	77.06	-68.40	16.02	-0.19	161.14
3.8	-9.23	147.53	-11.49	83.61	-64.92	94.39	-0.19	158.71
3.9	-9.24	146.05	-15.57	-1.69	-65.83	51.09	-0.20	156.25
4.0	-9.16	144.81	-8.70	-35.16	-62.72	67.81	-0.23	153.69
4.1	-9.01	143.67	-3.80	170.21	-64.35	63.03	-0.26	151.25
4.2	-8.77	142.00	-0.97	148.25	-60.54	50.84	-0.31	148.89

**S-Parameter<sup>[5]</sup> (Vdd = VddBias = 5.0 V, Vc1 = 2.4 V, Vc2 = 1.6 V, Vc3 = 2.2 V, TA = 25° C, 50ohm), continued**

Freq (GHz)	S11 (dB)	S11 (ang)	S21 (dB)	S21 (ang)	S12 (dB)	S12 (ang)	S22 (dB)	S22 (ang)
4.3	-8.63	139.37	0.00	117.18	-60.96	33.65	-0.39	146.77
4.4	-8.73	138.13	-1.86	82.59	-61.12	41.98	-0.42	145.05
4.5	-8.63	139.55	-7.11	57.81	-60.99	35.39	-0.39	143.24
4.6	-8.00	141.12	-14.73	75.62	-64.30	-0.11	-0.36	141.15
4.7	-7.06	140.09	-12.06	116.77	-63.38	52.25	-0.34	138.99
4.8	-6.14	136.11	-8.35	108.34	-63.94	51.05	-0.33	136.93
4.9	-5.49	129.96	-6.96	88.89	-61.63	15.61	-0.33	135.04
5.0	-5.15	123.56	-6.93	67.14	-64.21	11.62	-0.34	132.96
5.1	-5.15	118.26	-8.09	42.27	-61.39	30.39	-0.36	130.76
5.2	-5.38	115.24	-12.24	20.44	-63.82	37.09	-0.35	129.09
5.3	-5.20	111.70	-15.65	31.78	-61.86	41.29	-0.34	127.50
5.4	-5.31	107.33	-17.07	28.94	-62.86	45.83	-0.35	126.09
5.5	-5.44	104.12	-19.23	42.79	-63.68	31.55	-0.33	124.79
5.6	-5.47	100.09	-15.63	59.85	-63.14	25.77	-0.33	123.57
5.7	-5.93	95.36	-12.43	29.97	-64.74	-0.40	-0.32	122.56
5.8	-6.49	93.92	-13.43	1.76	-63.65	43.77	-0.31	121.60
5.9	-6.85	93.51	-15.03	-16.43	-63.91	30.65	-0.30	120.59
6.0	-7.11	93.13	-16.18	-30.70	-62.57	28.50	-0.29	119.75
7.0	-8.31	93.81	-25.85	91.56	-61.89	35.51	-0.19	113.46
8.0	-8.99	89.60	-27.22	44.19	-58.70	26.63	-0.28	97.34
9.0	-10.05	67.30	-29.18	-3.94	-55.56	0.62	-0.36	70.05
10.0	-9.22	47.21	-31.93	-41.22	-57.23	-15.48	-0.18	49.73
11.0	-7.02	50.16	-34.57	-71.69	-59.39	-20.92	-0.59	30.91
12.0	-7.25	44.19	-36.85	-96.94	-57.36	-39.60	-1.55	13.59
13.0	-11.42	33.20	-37.80	-130.84	-57.77	-29.55	-0.08	-11.14
14.0	-10.76	1.42	-38.32	-173.87	-54.03	-26.41	-0.42	-36.80
15.0	-9.44	-38.08	-41.32	128.69	-47.98	-33.03	-0.59	-51.91
16.0	-10.44	-116.93	-41.46	33.62	-44.76	-58.79	-0.63	-61.94
17.0	-8.09	125.59	-39.66	-72.54	-40.64	-96.96	-0.58	-70.62
18.0	-4.68	71.47	-45.58	-129.22	-44.72	-136.92	-0.46	-81.73
19.0	-3.84	41.22	-47.82	-144.14	-47.25	-140.61	-0.40	-91.57
20.0	-4.71	5.60	-45.55	-128.30	-42.88	-131.48	-0.55	-102.61

**S-Parameter<sup>[5]</sup> (Vdd = VddBias = 5.5 V, Vc1 = 2.4 V, Vc2 = 1.6 V, Vc3 = 2.2 V, TA = 25° C, 50ohm)**

Freq (GHz)	S11 (dB)	S11 (ang)	S21 (dB)	S21 (ang)	S12 (dB)	S12 (ang)	S22 (dB)	S22 (ang)
0.1	-0.29	175.00	-59.13	53.94	-54.17	-51.13	-0.55	175.32
0.2	-0.35	164.39	-52.00	-67.58	-61.93	-4.25	-0.88	173.48
0.3	-0.39	154.95	-44.30	-73.44	-61.17	25.89	-1.07	172.31
0.4	-0.38	145.31	-28.19	-65.50	-62.11	-1.81	-1.18	171.50
0.5	-0.95	135.10	-14.60	-163.35	-63.80	0.21	-1.22	171.42
0.6	-0.73	125.24	-15.28	-100.32	-63.69	144.82	-0.94	167.60
0.7	-0.74	109.90	3.29	-116.04	-64.98	94.53	-1.38	165.96
0.8	-2.45	80.34	18.98	103.41	-65.62	77.81	-1.60	165.47
0.9	-5.64	100.04	21.57	63.89	-66.07	71.12	-1.82	165.61
1.0	-3.72	82.61	12.93	18.44	-64.05	77.11	-1.56	166.94
1.1	-4.05	48.45	24.05	81.53	-66.96	33.57	-2.46	166.68
1.2	-15.24	24.79	34.58	25.03	-63.67	103.84	-0.99	166.08
1.3	-11.04	59.95	36.75	-46.85	-64.92	100.47	-0.51	161.00
1.4	-10.22	33.58	37.18	-93.55	-61.17	96.39	-0.46	154.81
1.5	-10.87	3.51	37.69	-130.50	-60.08	89.89	-0.67	148.74
1.6	-11.39	-29.72	38.41	-163.70	-58.91	93.27	-1.13	142.28
1.7	-11.18	-66.47	39.21	163.61	-58.71	87.79	-1.97	136.01
1.8	-10.97	-98.68	40.09	130.92	-56.45	82.16	-3.14	129.48
1.9	-11.21	-125.81	40.85	96.09	-54.29	69.54	-5.02	123.03
2.0	-13.12	-142.38	41.11	59.18	-53.68	57.14	-7.86	119.02
2.1	-15.16	-132.37	40.74	20.77	-52.35	41.28	-12.99	118.88
2.2	-11.88	-115.08	39.91	-12.30	-51.99	20.58	-22.19	-81.64
2.3	-8.15	-127.35	38.83	-53.32	-52.95	1.96	-8.48	-123.43
2.4	-6.65	-145.31	36.07	-90.57	-54.08	-15.77	-4.08	-138.45
2.5	-6.43	-160.23	32.70	-119.74	-55.17	-28.59	-2.25	-151.01
2.6	-6.64	-170.77	29.39	-142.69	-59.92	-42.79	-1.38	-160.16
2.7	-7.03	-106.67	26.23	-162.29	-59.60	-39.99	-0.92	-166.99
2.8	-7.45	175.50	23.23	-107.13	-62.52	-45.10	-0.67	-172.20
2.9	-7.79	171.07	20.38	165.96	-61.92	-33.21	-0.50	-176.43
3.0	-8.08	167.41	17.67	152.25	-66.53	-14.36	-0.39	-36.04
3.1	-8.32	164.27	15.03	139.59	-66.73	-61.70	-0.31	176.81
3.2	-8.51	161.24	12.41	127.46	-67.40	-33.90	-0.26	173.89
3.3	-8.68	158.61	9.73	115.94	-66.40	56.83	-0.23	171.20
3.4	-8.80	156.09	6.97	104.85	-68.41	52.44	-0.22	168.60
3.5	-8.89	153.71	3.94	94.15	-67.97	-1.70	-0.19	166.11
3.6	-8.98	151.23	0.40	84.19	-65.80	-28.66	-0.18	163.54
3.7	-9.04	149.19	-4.21	76.52	-67.70	8.32	-0.19	161.10
3.8	-9.07	147.35	-11.55	83.46	-66.16	44.47	-0.19	158.64
3.9	-9.07	145.84	-15.48	-1.64	-62.34	101.92	-0.20	156.17
4.0	-9.00	144.52	-8.63	36.00	-66.96	61.84	-0.22	153.64
4.1	-8.83	143.24	-3.77	169.25	-62.86	73.11	-0.25	151.19
4.2	-8.60	141.45	-0.97	147.17	-62.59	42.78	-0.31	148.83

**S-Parameter<sup>[5]</sup> (Vdd = VddBias = 5.5 V, Vc1 = 2.4 V, Vc2 = 1.6 V, Vc3 = 2.2 V, TA = 25° C, 50ohm) continued**

Freq (GHz)	S11 (dB)	S11 (ang)	S21 (dB)	S21 (ang)	S12 (dB)	S12 (ang)	S22 (dB)	S22 (ang)
4.3	-8.47	138.73	-0.05	116.04	-60.02	41.20	-0.38	146.72
4.4	-8.58	137.44	-1.99	81.68	-60.51	14.80	-0.40	145.00
4.5	-8.49	138.69	-7.28	57.51	-61.97	18.14	-0.38	143.17
4.6	-7.89	140.10	-14.78	76.52	-65.41	43.49	-0.34	141.04
4.7	-6.99	139.03	-11.98	116.38	-63.72	52.82	-0.33	138.90
4.8	-6.11	135.16	-8.34	107.69	-62.39	36.90	-0.31	136.85
4.9	-5.49	129.19	-6.98	88.27	-61.97	40.51	-0.30	134.96
5.0	-5.15	123.03	-6.97	66.51	-62.93	34.28	-0.32	132.89
5.1	-5.16	117.93	-8.15	41.56	-63.10	32.09	-0.33	130.68
5.2	-5.37	115.08	-12.41	20.17	-62.46	45.10	-0.32	129.01
5.3	-5.19	111.51	-15.67	31.89	-61.14	41.14	-0.32	127.41
5.4	-5.30	107.26	-17.14	29.01	-63.03	38.26	-0.32	126.03
5.5	-5.41	104.10	-19.21	43.42	-61.06	30.74	-0.31	124.71
5.6	-5.43	100.03	-15.47	59.16	-62.20	10.54	-0.30	123.49
5.7	-5.89	95.45	-12.44	28.99	-62.44	33.84	-0.30	122.48
5.8	-6.43	94.02	-13.48	1.22	-64.78	57.64	-0.28	121.52
5.9	-6.77	93.62	-15.07	-16.78	-63.66	30.94	-0.28	120.51
6.0	-7.01	93.20	-16.20	-31.04	-64.00	47.41	-0.27	119.66
7.0	-8.18	93.27	-25.88	91.47	-59.95	50.54	-0.18	113.38
8.0	-8.89	88.46	-27.26	44.60	-57.94	34.92	-0.28	97.21
9.0	-10.00	65.66	-29.14	-3.68	-55.93	3.04	-0.37	69.88
10.0	-9.25	45.56	-31.82	-41.17	-58.35	-23.54	-0.17	49.51
11.0	-7.15	48.91	-34.52	-72.20	-57.79	-19.00	-0.57	30.67
12.0	-7.48	43.14	-36.79	-97.15	-58.73	-33.66	-1.54	13.34
13.0	-11.85	32.74	-37.74	-130.74	-54.91	-27.79	-0.09	-11.44
14.0	-11.17	1.06	-38.45	-172.97	-54.05	-29.57	-0.42	-37.14
15.0	-9.80	-38.75	-41.52	129.09	-47.98	-32.68	-0.59	-52.23
16.0	-10.70	-119.43	-41.53	33.60	-44.08	-59.74	-0.61	-62.26
17.0	-7.95	124.07	-39.52	-72.70	-40.66	-96.97	-0.56	-70.91
18.0	-4.58	70.71	-45.94	-132.50	-44.68	-134.82	-0.46	-82.04
19.0	-3.82	40.60	-47.04	-144.31	-47.32	-138.16	-0.42	-91.85
20.0	-4.71	4.74	-46.00	-129.98	-42.95	-132.97	-0.56	-102.95

Notes:

5. S-parameter is measured with deembedded reference plane at DUT RFin and RFout pins.

### Demonstration Board Top View (Vdd=VddBias=5.0V, Vdd=VddBias=5.5V operating voltage)

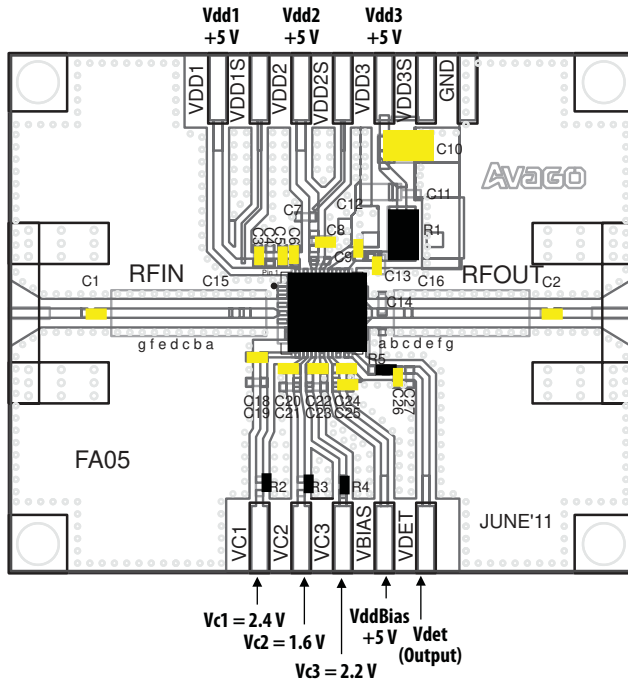

Component	Value	Part Number
C1, C2	8.2 pF +/- 0.5 pF	GJM1555C1H8R2WB01D
C3, C8, C13, C25	0.1 μF +/- 10%	GRM155R71C104KA88D
C5, C9	82 pF +/- 5%	GRM1555C1H820JA01D
C6, C18, C20, C22	8.2 pF +/- 0.5 pF	GJM1555C1H8R2WB01D
C24	3.6 pF +/- 0.25 pF	GJM1555C1H3R6CB01D
C10	2.2 μF +/- 10%	GRM21BR71E225KA73L
C26	22 nF +/- 10%	CM05X7R223K16AHF
R1	0 Ω	RMC1/10 JPTP
R2, R3, R4, R5	0 Ω	RMC1/16S JPTH

Note:

For performance optimization control voltage for individual stages can be adjusted by varying R2, R3 and R4 resistor value.

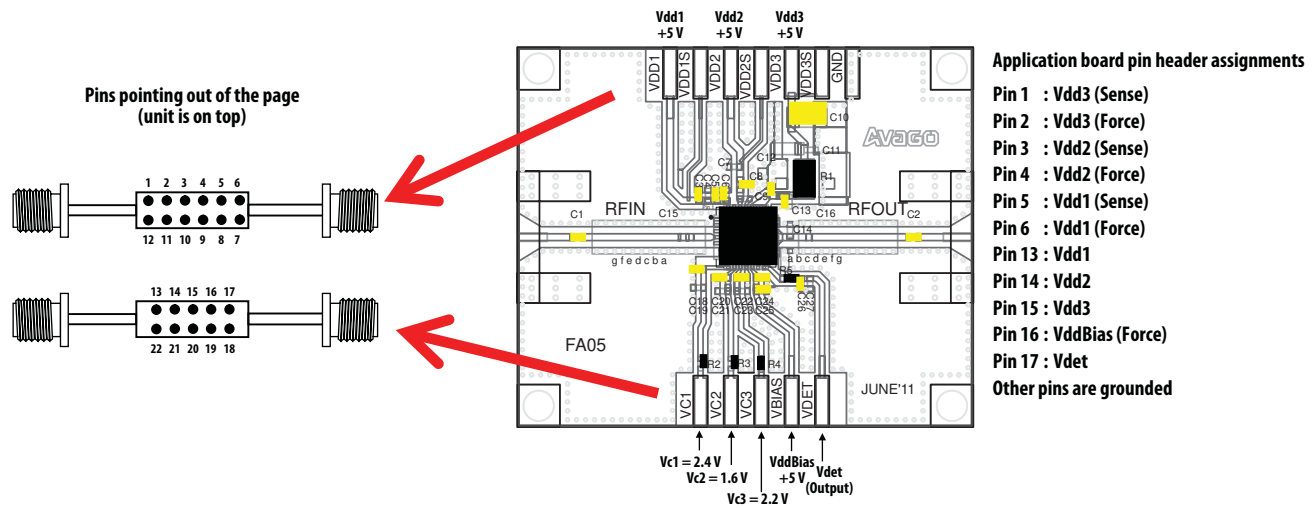
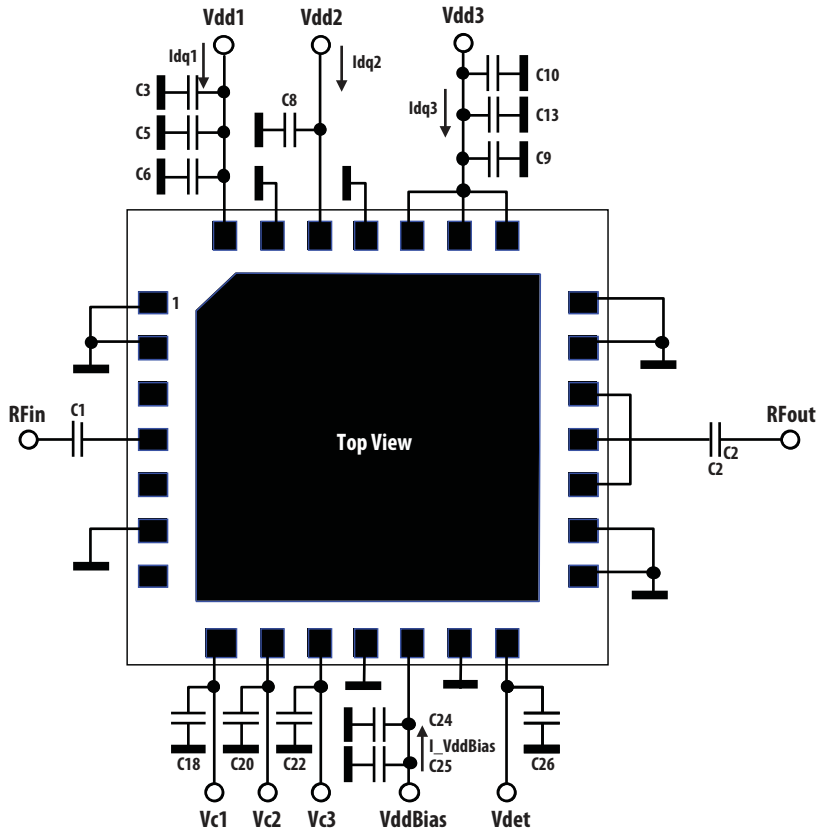

Figure 30. Demonstration board application circuit for MGA-43628 module

## Application Schematic



**Figure 31. Application schematic in demonstration board**

**Notes:**

1. All capacitors on supply lines are bypass capacitors
2. C1 / C2 are RF coupling capacitors.
3. Idq1= 60.0 mA, Idq2 = 110 mA, Idq3 = 270.0 mA, I\_VddBias = 14.0 mA. Idq1/2/3 are adjusted by voltages to CMOS-compatible control pins Vc1/2/3 respectively. These typical bias currents were obtained with Vc1/2/3 voltages in Figure 30 above. Adjustment of these currents enable optimum bias conditions to be achieved for best linearity and efficiency for a given modulation type

**MGA-43628 typical  $I_{c1}$ ,  $I_{c2}$ ,  $I_{c3}$  Vs  $V_c$  performance unless otherwise stated**

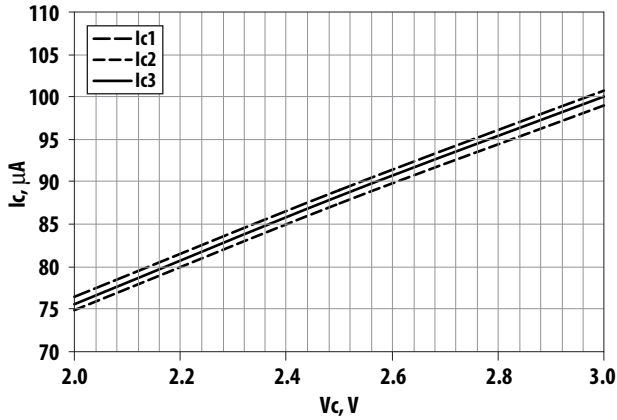

Figure 32.  $I_c$  Versus  $V_c$  at  $V_{dd} = V_{ddBias} = 5.0$  V

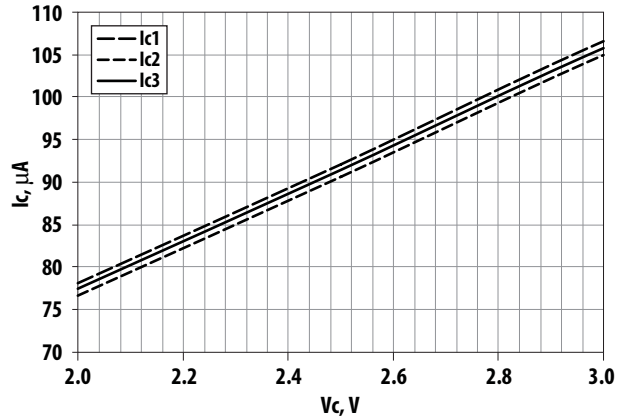
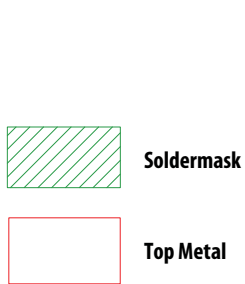
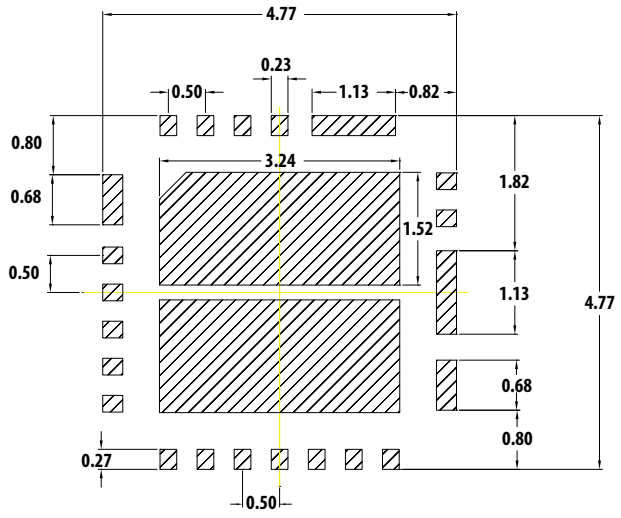
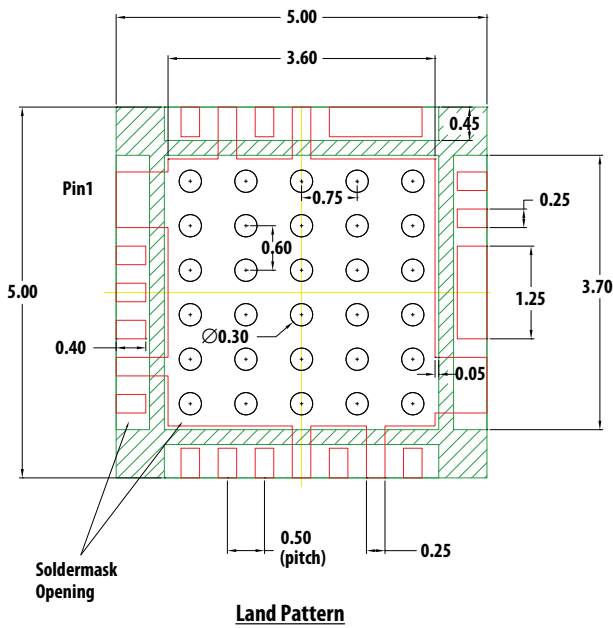

Figure 33.  $I_c$  Versus  $V_c$  at  $V_{dd} = V_{ddBias} = 5.5$  V

**PCB Land Pattern and Stencil Outline**



**Note :**

1. Recommended Land Pattern and Stencil.
2. 4 mils stencil thickness recommended.
3. All dimensions are in mm

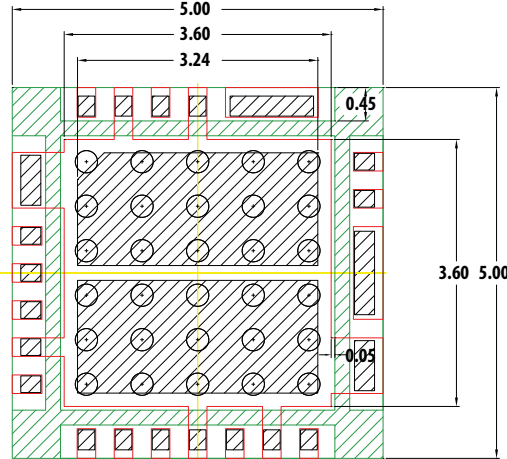

**Combination of Land Pattern & Stencil Opening**

## MCOB (5.0 x 5.0 x 0.9) mm 28-Lead Package Dimensions

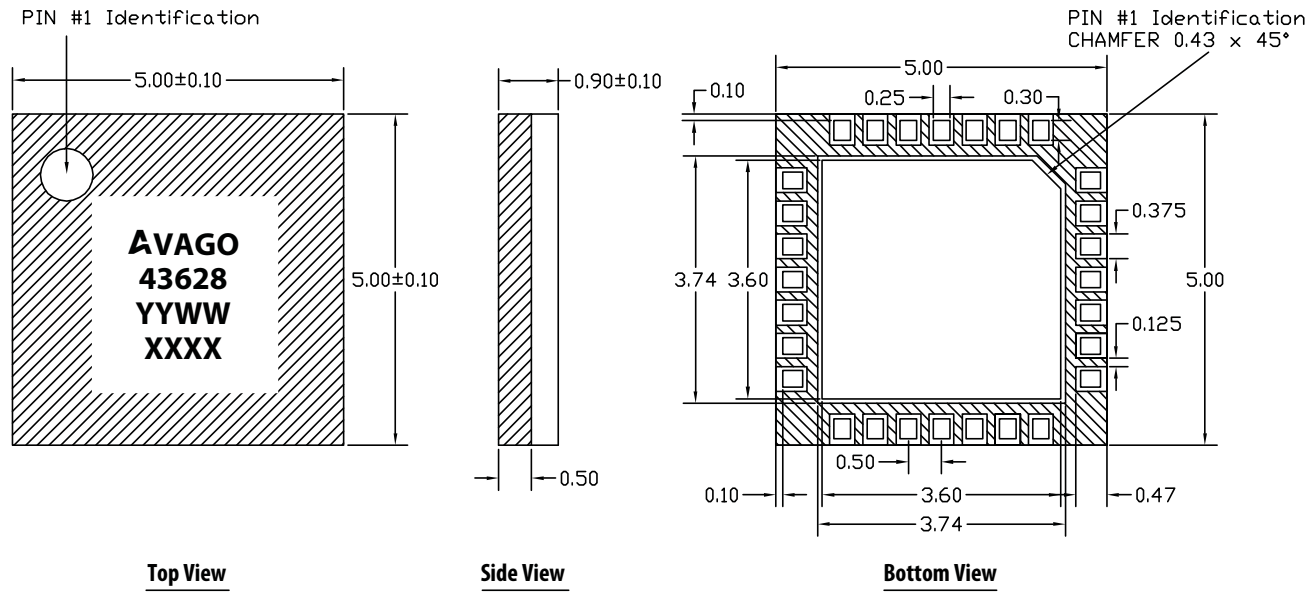

### Note

1. All dimensions are in millimeters.
2. Dimensions are inclusive of plating.
3. Dimensions are exclusive of mold flash and metal burr.

### Part Number Ordering Information

Part Number	Qty	Container
MGA-43628-BLKG	100	Antistatic Bag
MGA-43628-TR1G	1000	7" Reel



## Device Orientation

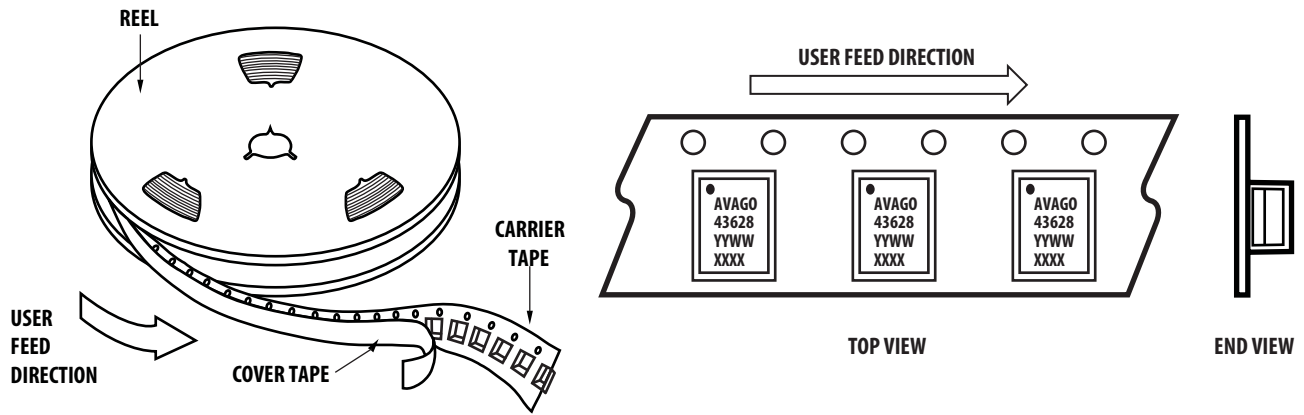

## Tape Dimensions

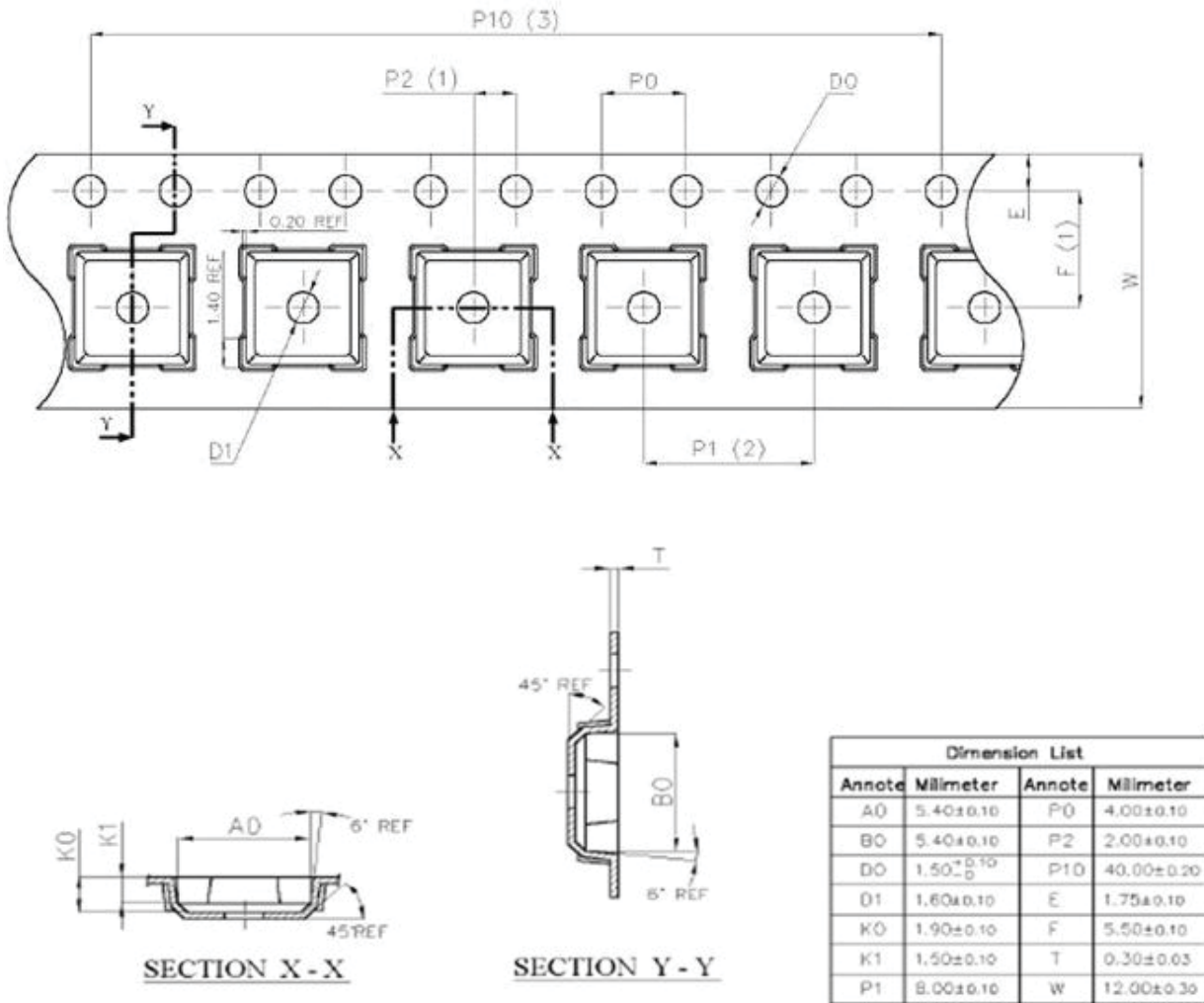

# Reel Dimensions (7" reel)

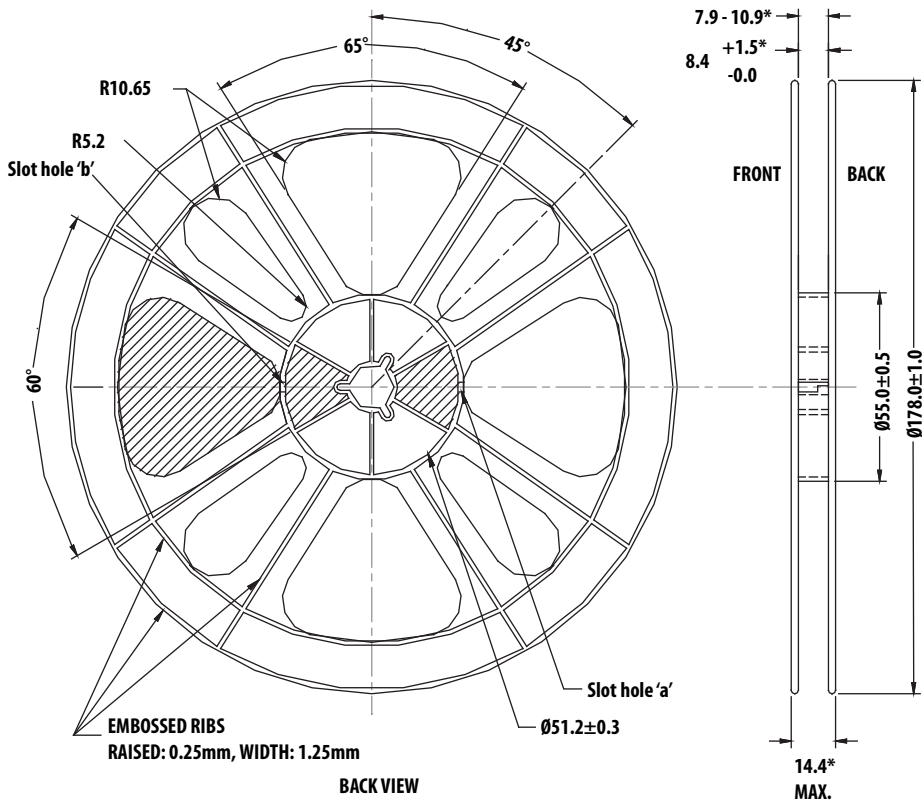
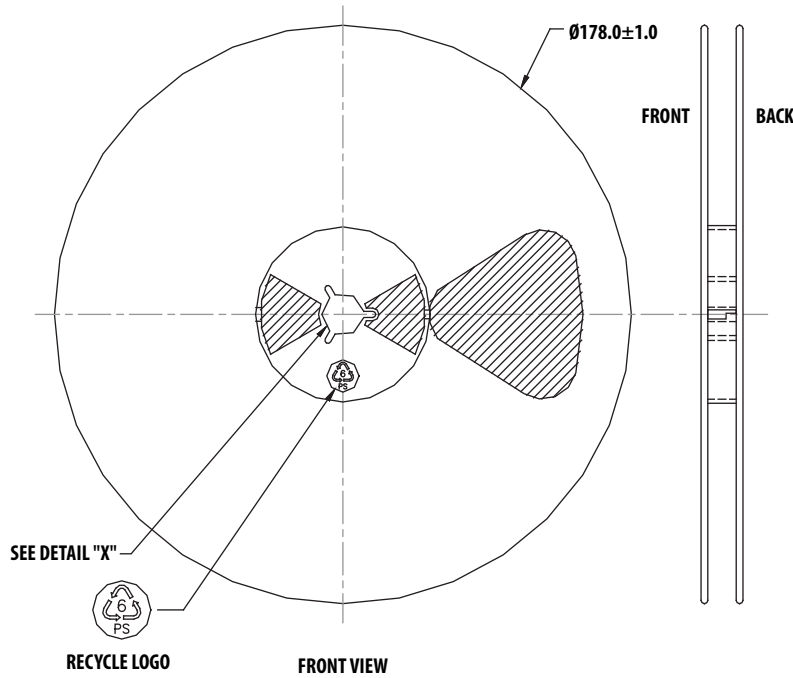

For product information and a complete list of distributors, please go to our web site: [www.avagotech.com](http://www.avagotech.com)

Avago, Avago Technologies, and the A logo are trademarks of Avago Technologies in the United States and other countries. Data subject to change. Copyright © 2005-2012 Avago Technologies. All rights reserved. AV02-3741EN - October 31, 2012

