



MATE-N-LOK | Mini-Universal MATE-N-LOK

TE Internal #: 170363-4

Power Contacts, Contact, 600 VAC, 600 VDC, Tin, 26 – 22 AWG
 Wire Size, .12 – .35 mm² Wire Size, Wire & Cable, Crimp, Power,
 Mini-Universal MATE-N-LOK

[View on TE.com >](#)

Connectors > Power Connectors > Power Contacts



Power Contact Type: **Contact**

Operating Voltage: **600 VDC**

Contact Mating Area Plating Material: **Tin**

Wire Size: **26 – 22 AWG**

Features

Product Type Features

Compatible With Discrete Wire Type	Stranded
Power Contact Type	Contact
Connector & Contact Terminates To	Wire & Cable

Electrical Characteristics

Operating Voltage	600 VDC
-------------------	---------

Contact Features

Barrel Type	Open
Contact Mating Area Plating Material	Tin
Contact Current Rating (Max)	7 A
Contact Type	Pin
Contact Retention Within Housing	With
Mating Pin Diameter	1 mm[.039 in]
Contact Base Material	Phosphor Bronze
Contact Mating Area Plating Material Thickness	.8 μm[31.49 μin]
Wire Contact Termination Area Plating Thickness	.8 μm[31.49 μin]



Wire Contact Termination Area Plating Material	Pre-Tin
Wire Contact Termination Area Plating Material Finish	Matte
Contact Orientation	Straight

Termination Features

Termination Method to Wire & Cable	Crimp
------------------------------------	-------

Mechanical Attachment

Wire Insulation Support	Without
-------------------------	---------

Dimensions

Wire Size	.12 – .35 mm ²
Compatible Insulation Diameter Range	1.19 – 1.75 mm [.047 – .069 in]

Usage Conditions

Operating Temperature Range	-20 – 105 °C [-4 – 221 °F]
-----------------------------	----------------------------

Operation/Application

Circuit Application	Power
---------------------	-------

Industry Standards

CSA Rating	Certified, LR 7189
UL Rating	Recognized
Agency/Standard	CSA, UL

Packaging Features

Packaging Quantity	1000
Packaging Method	Bag

Product Compliance

[For compliance documentation, visit the product page on TE.com>](#)

EU RoHS Directive 2011/65/EU	Compliant
EU ELV Directive 2000/53/EC	Compliant
China RoHS 2 Directive MIIT Order No 32, 2016	No Restricted Materials Above Threshold
EU REACH Regulation (EC) No. 1907/2006	Current ECHA Candidate List: JUNE 2023 (235) Candidate List Declared Against: JUNE 2023 (235) Does not contain REACH SVHC
Halogen Content	Low Halogen - Br, Cl, F, I < 900 ppm per

homogenous material. Also BFR/CFR/PVC Free

Solder Process Capability

Not applicable for solder process capability

Product Compliance Disclaimer

This information is provided based on reasonable inquiry of our suppliers and represents our current actual knowledge based on the information they provided. This information is subject to change. The part numbers that TE has identified as EU RoHS compliant have a maximum concentration of 0.1% by weight in homogenous materials for lead, hexavalent chromium, mercury, PBB, PBDE, DBP, BBP, DEHP, DIBP, and 0.01% for cadmium, or qualify for an exemption to these limits as defined in the Annexes of Directive 2011/65/EU (RoHS2). Finished electrical and electronic equipment products will be CE marked as required by Directive 2011/65/EU. Components may not be CE marked. Additionally, the part numbers that TE has identified as EU ELV compliant have a maximum concentration of 0.1% by weight in homogenous materials for lead, hexavalent chromium, and mercury, and 0.01% for cadmium, or qualify for an exemption to these limits as defined in the Annexes of Directive 2000/53/EC (ELV). Regarding the REACH Regulation, the information TE provides on SVHC in articles for this part number is based on the latest European Chemicals Agency (ECHA) 'Guidance on requirements for substances in articles' posted at this URL: <https://echa.europa.eu/guidance-documents/guidance-on-reach>

Compatible Parts



TE Part # 91529-1
CCII MINI-UMNL PIN 26-22 ASSY

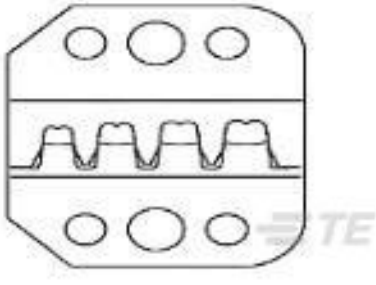

TE Part # 90758-2
PROCRIMP DIE MINI UNIV MNL



TE Part # 455830-1
INSERTION TOOL



TE Part # 770586-1
22P MINI UMNL PLUG HSG



TE Part # 770587-1
24P MINI UMNL PLUG HSG



TE Part # 770582-1
14P MINI UMNL PLUG HSG



TE Part # 770585-1
20P MINI UMNL PLUG HSG



TE Part # 172333-1
MINI UNIVERSAL M-N-L HOUSING



TE Part # 770581-1
12P MINI UMNL PLUG HSG



TE Part # 770580-1
10P MINI UMNL PLUG HSG



TE Part # 770584-1
18P MINI UMNL PLUG HSG



TE Part # 172328-1
MINI UNIVERSAL MATE-N-LOK CAP HOUSING 2P



Also in the Series | Mini-Universal MATE-N-LOK

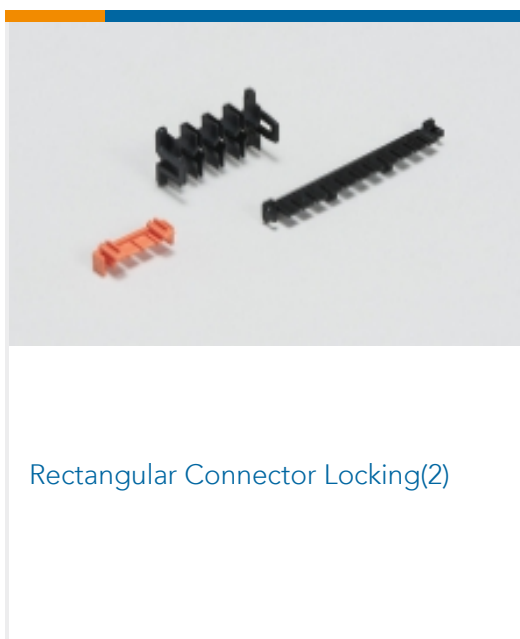
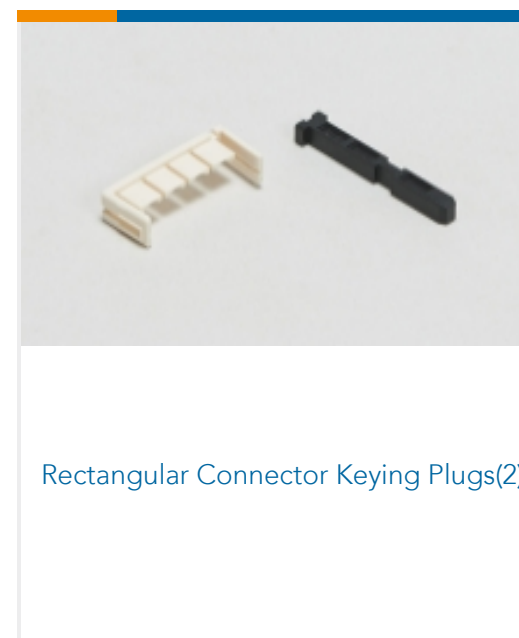
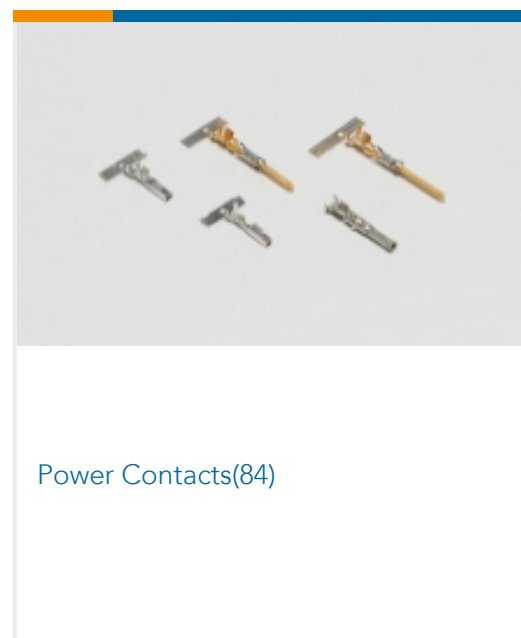
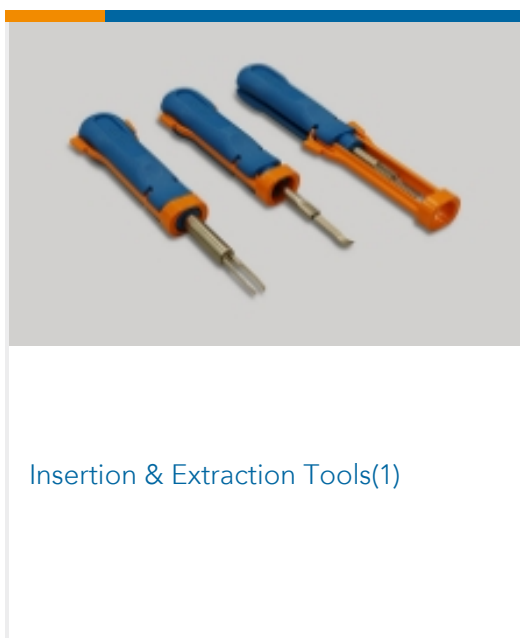
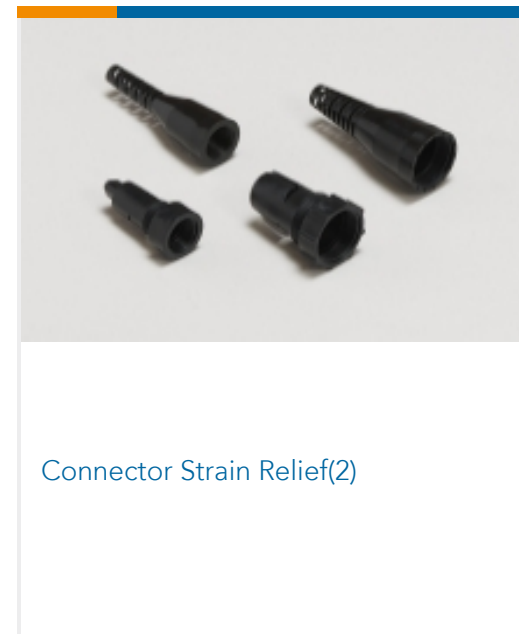
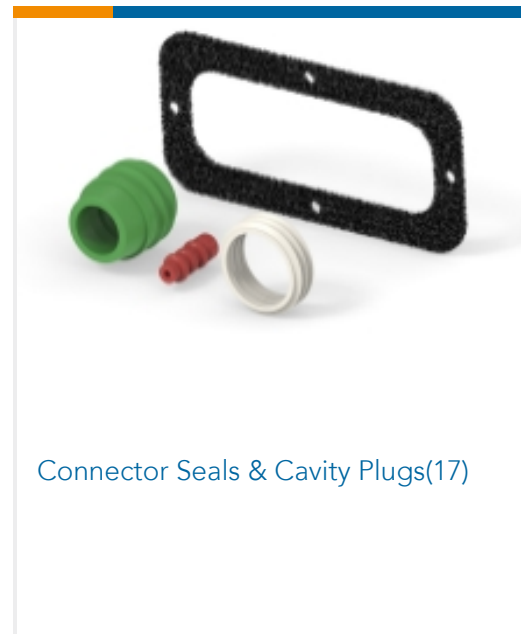
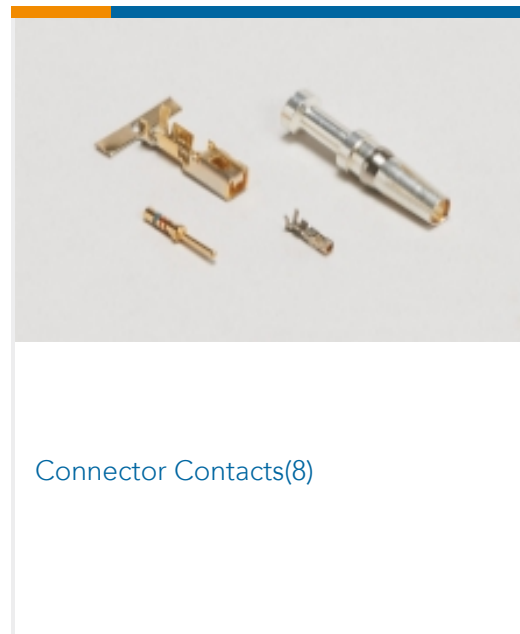
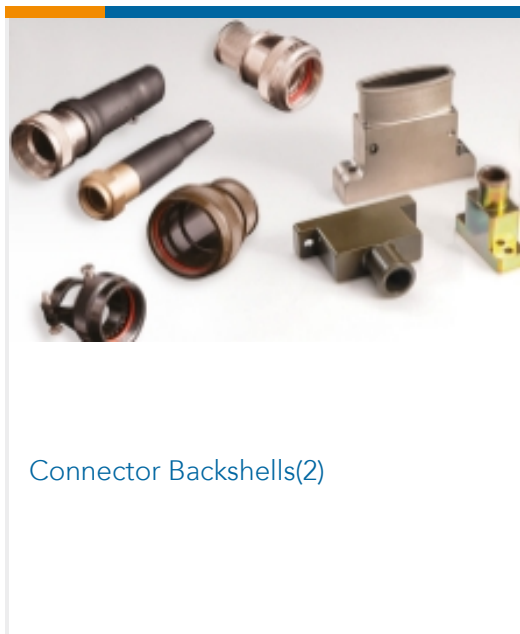

Customers Also Bought

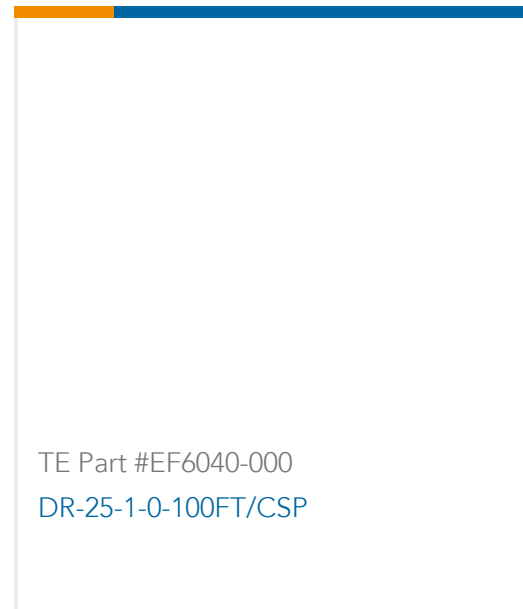

Documents

Product Drawings

MINI UNIVERSAL M-N-L PIN LP

English

CAD Files

3D PDF

3D

Customer View Model

[ENG_CVM_CVM_170363-4_1_c-170363-4-1.2d_dxf.zip](#)

English

Customer View Model

[ENG_CVM_CVM_170363-4_1_c-170363-4-1.3d_igs.zip](#)

English

Customer View Model

[ENG_CVM_CVM_170363-4_1_c-170363-4-1.3d_stp.zip](#)

English

By downloading the CAD file I accept and agree to the [Terms and Conditions](#) of use.

Product Specifications

Crimping of Mini-Universal MATE-N-LOK Contact

Japanese

Application Specification

Japanese

Instruction Sheets

Instruction Sheet (non U.S.)

Japanese



Mini-Universal MATE-N-LOK Connector

Japanese