

Specifications:

connector description (1)	4P standard DIN male, molding style, brass, nickel plating, 210°, P/N 50-00171
overmold (2)	inner: PE; outer: 60P, PVC, black
wire description (3)	4C, 26 AWG, UL2464, 300V, 80C, 4.70 mm, shielded, VW-1, PVC, 60P, P/N 30-00061
cable outer diameter	Ø4.7 mm
cable color	black
cable length	1830 ± 50 mm
twist tie (4)	black
shrink tube (5)	Ø5.0, 105°C, 10 ± 2 mm, black
shrink tube (6)	Ø1.0, 105°C, 30 ± 5 mm, black
current rating	300 mA @ 12 Vdc

Notes:

Function test: no open, no reversed polarity, no short circuit, no INT
 RoHS compliant

Mechanical drawing:

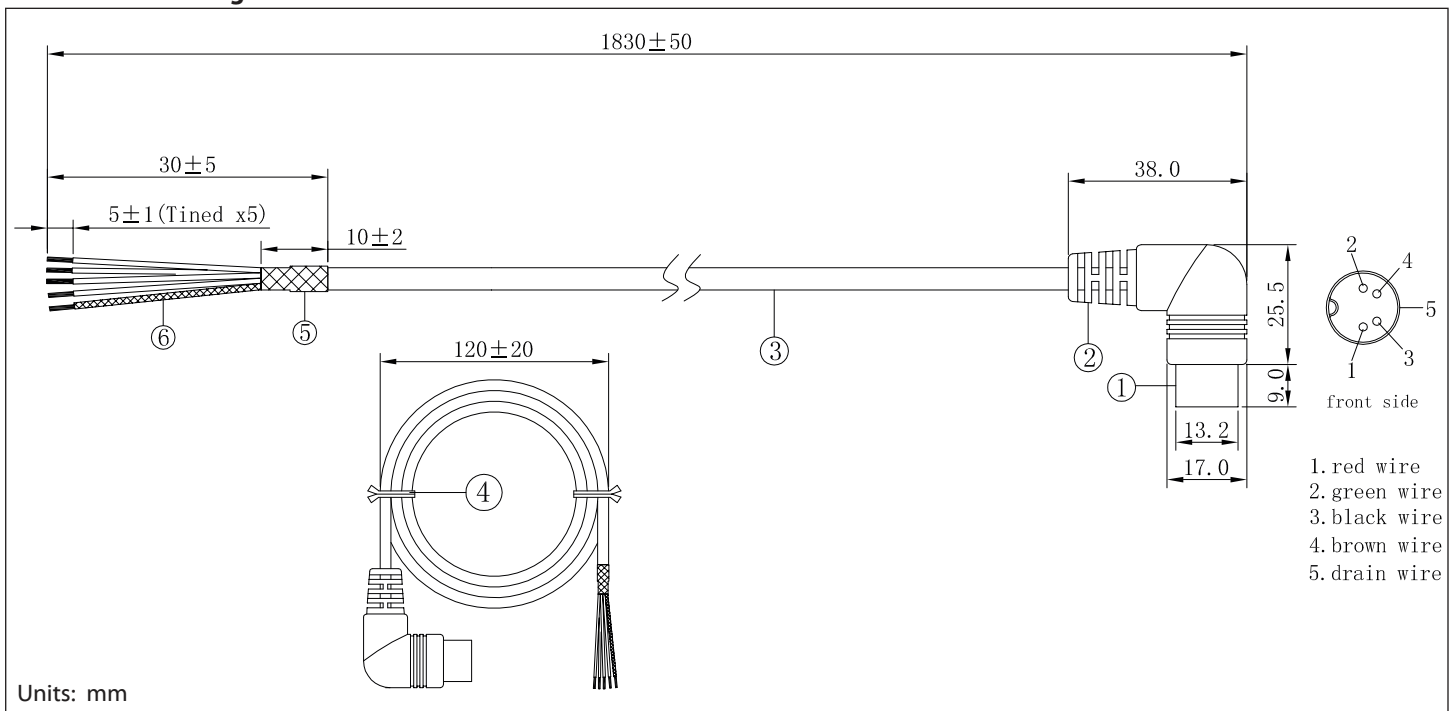

tolerance X: ±0.5 mm .X: ±0.3 mm .XX: ±0.05 mm
 applicable unless otherwise indicated in specification or on drawings
 Tensility International Corporation reserves the right to substitute
 parts which are functionally equivalent to the ones specified.

Initial

Date

Revision notes:

Rev	Date	Description
A	March 10, 2011	initial release

Specification Approval

Spec sign-off verifies that you have reviewed the entire specification, tested a sample of the product, and confirm that it meets your requirements. This specification reflects the part as it will be ordered. Orders will not be processed until the specification pages have been initialed and the approval page has been signed. This specification is confidential and is not to be transmitted without prior approval from Tensility.

Signature _____

Title _____

Name _____

Date _____

Company _____

Branch _____