

Product Type	Current transformer 50A
AMGIS Part Number	ASM-050
Customer Part Number	
Customer	

SCHEMATIC:

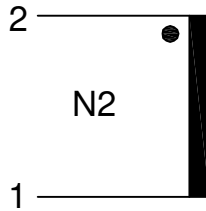

ELECTRICAL SPECIFICATION:

- Rated input current : 5 - 50 Amps
- Primary to Secondary isolation : 2500VAC
- Operating frequency : 50 / 60Hz
- Operating temperature range : -40°C to +120°C

LOAD TEST DETAILS:

$I_p=50A$
 $R_L=220\Omega$
 $U_s=100mV\pm 10\%$

MARKING INFORMATION:

AMGIS
 YY/Wk code ASM-050

MECHANICAL DIMENSIONS:

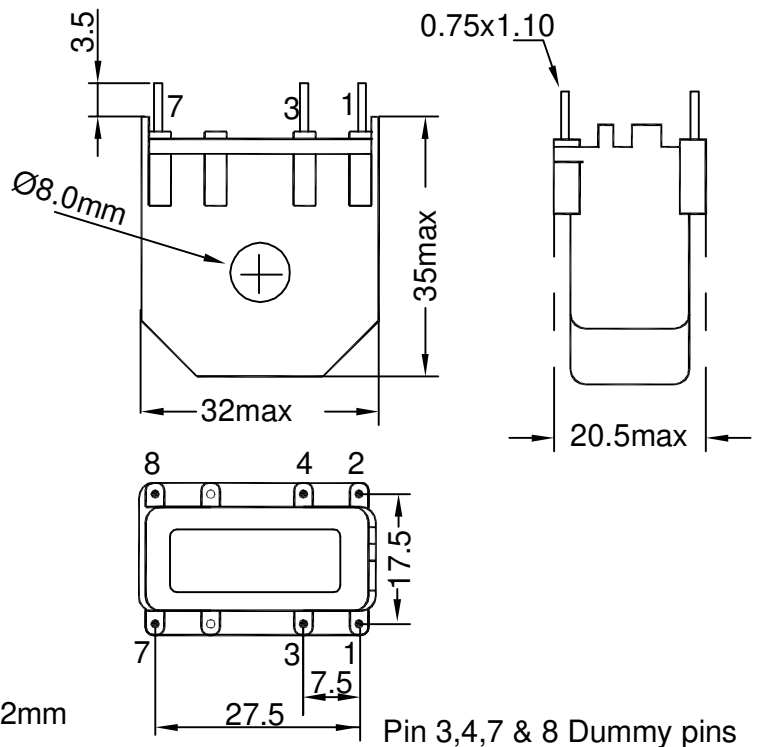

All dimensions are in mm
 Linear dimensional tolerance $\pm 0.2mm$

-----Issued-----	1	0	Anidha.K	04-Nov '10
Changes	Issue	Rev	Initial	Date