

DRV8821/DRV8823 User's Guide

This document is provided as a supplement to the [DRV8821/DRV8823](#) datasheet. It details the hardware implementation of the CPG003 DRV8821-23EVM-001 Customer Evaluation Module (EVM).

Contents

1	Block Diagram	3
	1.1 Power Connectors	3
	1.2 Test Stakes	3
	1.3 Jumpers	4
	1.4 Motor Outputs	4
2	GUI Software Installation	4
	2.1 System Requirements	5
	2.2 Installation Procedure	5
3	The Windows Application	16
	3.1 DRV8821 GPIO Control Signals	17
	3.2 Updating DAC Output for Current Control (VREF)	18
	3.3 Operating the Stepper Motor (DRV8821)	18
	3.4 Operating the Motors (DRV8823)	21
	3.5 Updating DAC Output for Reference Voltage	22
4	Menu Options	22

List of Figures

1	VREF Select Jumpers (JP1 and JP2)	4
2	DECAY Select Jumpers (JP3 and JP4)	4
3	Setup_DRV8821/DRV8823_EVM.exe	5
4	Installation Initialization	5
5	License Agreement	6
6	NI License Agreement	6
7	Installation Directory Screen	7
8	Component Selection	7
9	Configure Proxy	8
10	Ready to Install	8
11	Downloading RTE	9
12	LabVIEW RTE Self Extraction	9
13	LabVIEW RTE Installation Initialization	10
14	Installation of LabVIEW RTE in Progress	11
15	FTDI Installation Initialization	12
16	Driver Installation Wizard	12
17	License Agreement for FTDI Driver	13
18	Driver Installation Completion	14
19	Installation Complete	14
20	Readme Window	15
21	CPG003_DRV8821-23EVM-001_R1p0.exe Main Screen (DRV8821)	16
22	CPG003_DRV8821-23EVM-001_R1p0.exe Main Screen (DRV8823)	17

23	Control Signals Frame	17
24	Current Control Frame.....	18
25	Turning the Stepper Motor	19
26	Speed control Frame	19
27	Step Control Frame	20
28	Motor A and B Frame.....	21
29	Reference Voltage Frame.....	22
30	File Menu	22
31	Debug Menu	22
32	Help Menu	23
33	About Page	23

Trademarks

All trademarks are the property of their respective owners.

1 Block Diagram

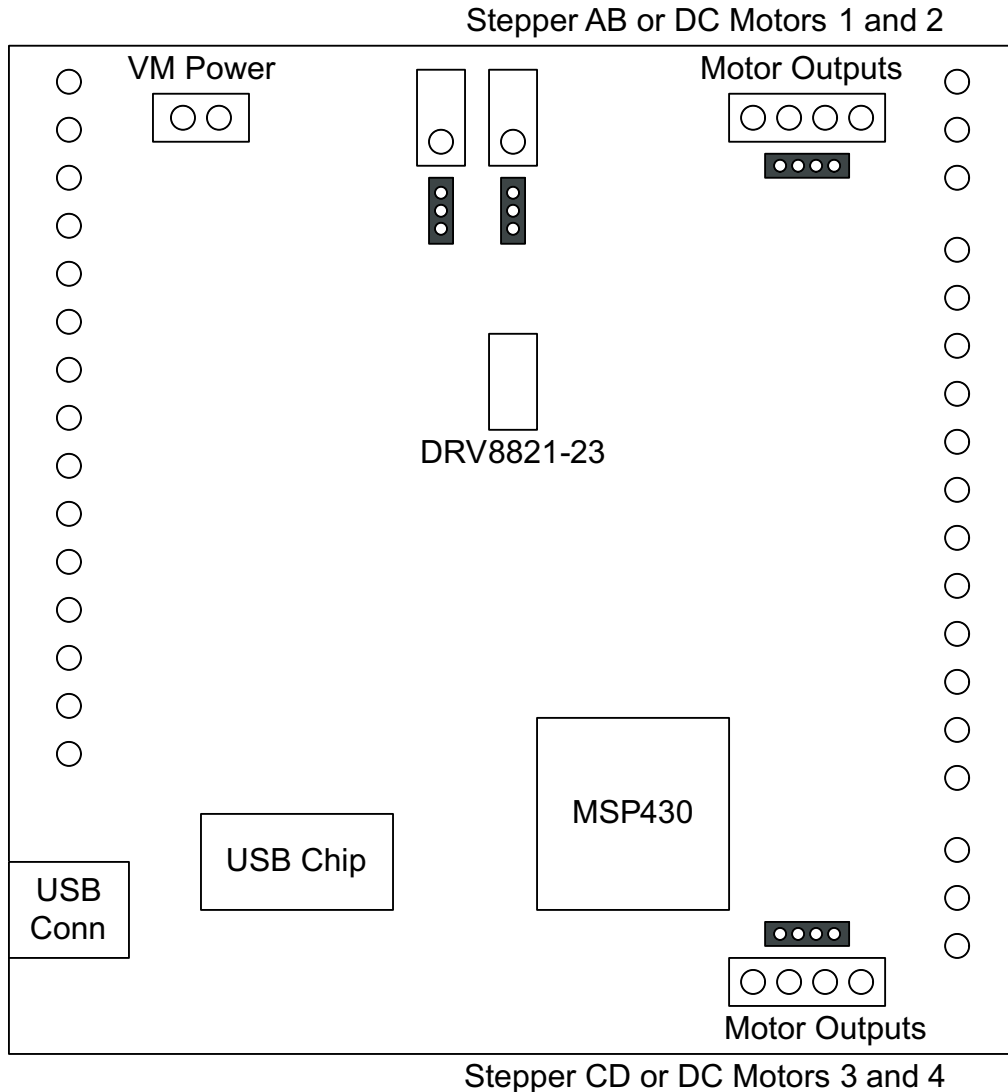

1.1 Power Connectors

The DRV8821/DRV8823 Customer EVM offers access to VM (Motor Voltage) power rail via a terminal block (J1). A set of test clips in parallel with the terminal block allows for the monitoring of the input power rail.

User must apply VM according to datasheet recommended parameters.

NOTE: VDD for logic and microcontroller is derived from USB interface.

1.2 Test Stakes

Every pin on the DRV8821/DRV8823 device has been brought out to a test stake. A label on the silkscreen identifies each signal.

For those pins that change functionality depending on device flavor, a table is provided with corresponding function name on its particular column.

1.3 Jumpers

There are two styles of jumpers on the DRV8821-23EVM: two pin jumpers (JP3 and JP4) and three pin jumpers (JP1 and JP2).

Two pin jumpers are used to set AB DECAY or CD DECAY HI or LO.

Three pin jumpers are used to select the VREF from a pot or from the microcontroller's DAC outputs.

1.3.1 VREF Select Jumpers (JP1 and JP2)

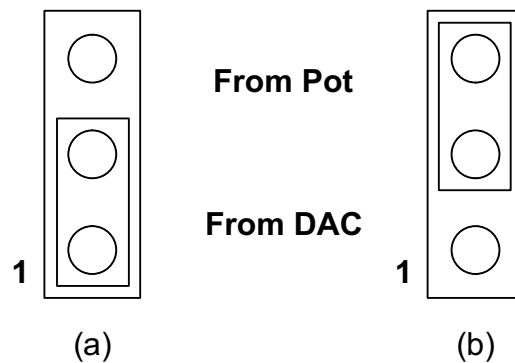

Figure 1. VREF Select Jumpers (JP1 and JP2)

To configure the VREF select (either AB or CD) jumper, (a) Use position JPx-1:2 to select the MSP430 DAC output (default). (b) Use position JPx-2:3 to select the respective variable resistance potentiometer. These jumpers should not be left open as a lack of a reference voltage on the device will minimize current sourcing into the respective H Bridge, resulting in very poor motion or no motion at all.

1.3.2 DECAY Select Jumpers (JP3 and JP4)

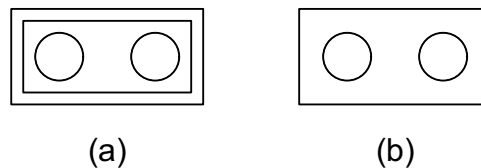

Figure 2. DECAY Select Jumpers (JP3 and JP4)

To configure the DECAY select jumper: (a) place a jumper to set the respective DECAY signal HI. (b) remove the jumper to use internal pull down resistor and set the DECAY signal to LO.

1.4 Motor Outputs

There are three ways of connecting the bipolar stepper motor (for DRV8821) or the dual DC motors (for DRV8823) into the CPG003_DRV882123EVM-001 evaluation module: four pin header (J4 and J5), four position terminal block (J2 and J3) and test clips. We do not recommend the connection of a stepper motor into the test clips as these are Kelvin connections and not rated for high current output.

2 GUI Software Installation

The following section explains the location of files and the procedure for installing the software correctly.

NOTE: Ensure that no USB connections are made to the EVM until the installation is completed. The installer will also install LabVIEW RTE 2014 and FTDI Driver, along with the GUI.

2.1 System Requirements

- Supported OS – Windows 7 (32 Bit,64 Bit). The window text size should be Smaller-100% (Default)
- Recommended RAM - 4 GB or higher
- Recommended CPU Operating Speed – 3.3 GHz or higher

2.2 Installation Procedure

The following procedure helps you install the DRV8821/DRV8823 GUI

1. Double click on the **Setup_DRV8821/DRV8823_EVM.exe** as shown in [Figure 3](#).

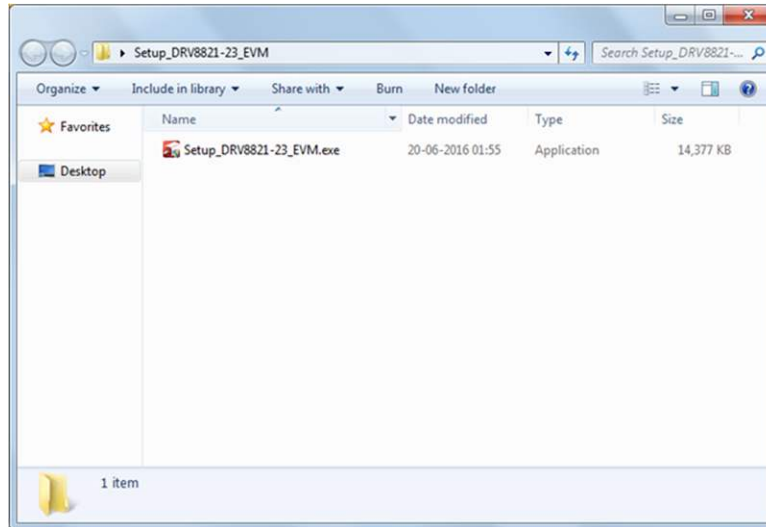

Figure 3. Setup_DRV8821/DRV8823_EVM.exe

2. The screen shown in [Figure 4](#) appears, indicating installer initialization. Click the **Next** button.



Figure 4. Installation Initialization

3. In the newly open installation pop-up window, click **Next**. The license agreement will be displayed. Please, read through it carefully and enable the "I Accept the Agreement" radio button and press **Next**.



Figure 5. License Agreement

4. A screen as shown in [Figure 6](#) appears, displaying the license agreement of National Instruments. Please read through the agreement carefully and enable the “I Accept the License Agreement” radio button and press the **Next** button.



Figure 6. NI License Agreement

5. Set the default directory for the GUI Installation and click **Next**.

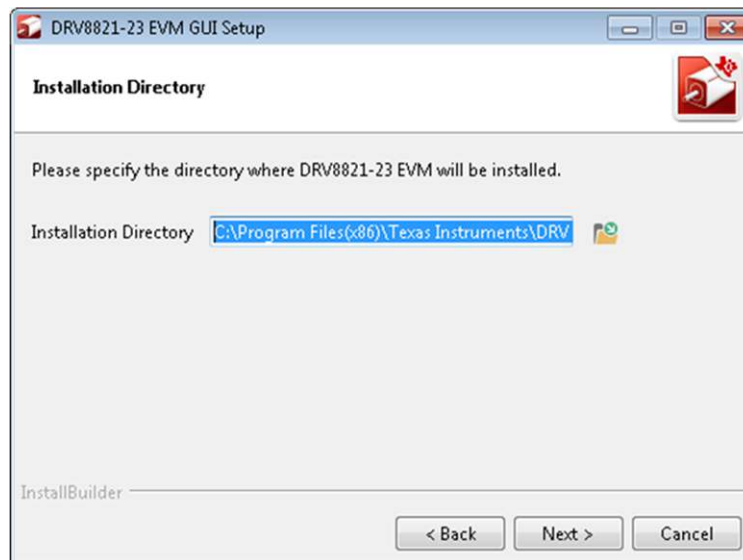

Figure 7. Installation Directory Screen

NOTE: It is highly recommended to keep the default values as provided in the installer.

6. A screen as shown in [Figure 8](#) appears. This screen is to select the components to install. Select the Components to Install and Click **Next** to continue installation. The LabVIEW RTE component checks out if the LabVIEW RTE 2014 is already installed on the PC.

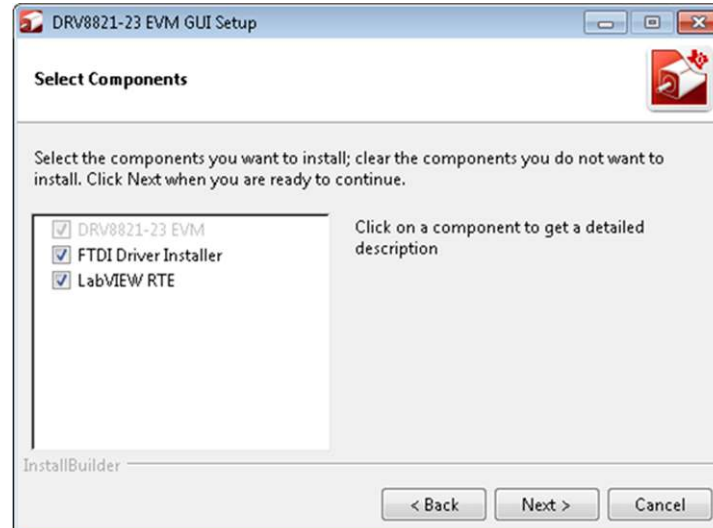

Figure 8. Component Selection

7. If LabVIEW RTE is selected as a component to install, a screen appears as shown in [Figure 9](#). Configure the proxy settings as required. This screen is to download the LabVIEW RTE 2014 from ni.com, Click **Next** to continue the installation.

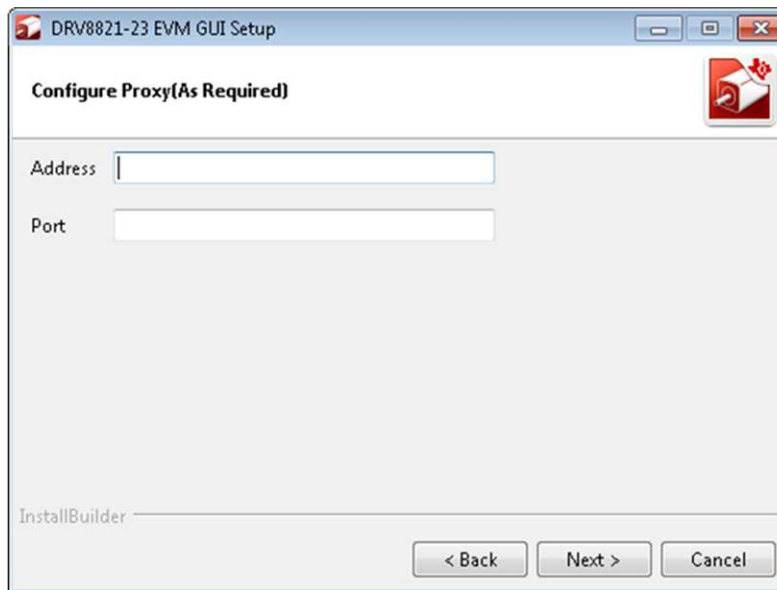

Figure 9. Configure Proxy

8. A screen as shown in [Figure 10](#) appears. Click **Next** to begin the installation.

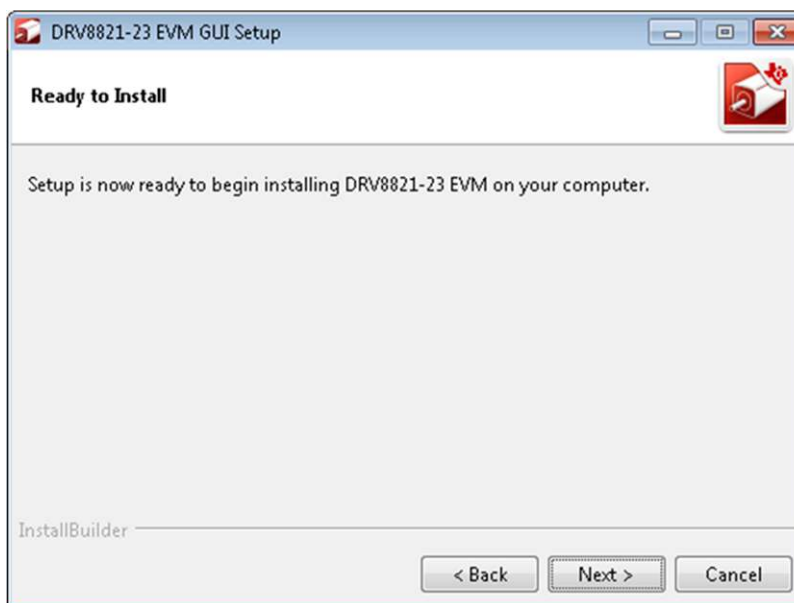

Figure 10. Ready to Install

9. If the LabVIEW RTE 2014 is selected as a component to install, LabVIEW RTE downloads and performs a silent mode installation.

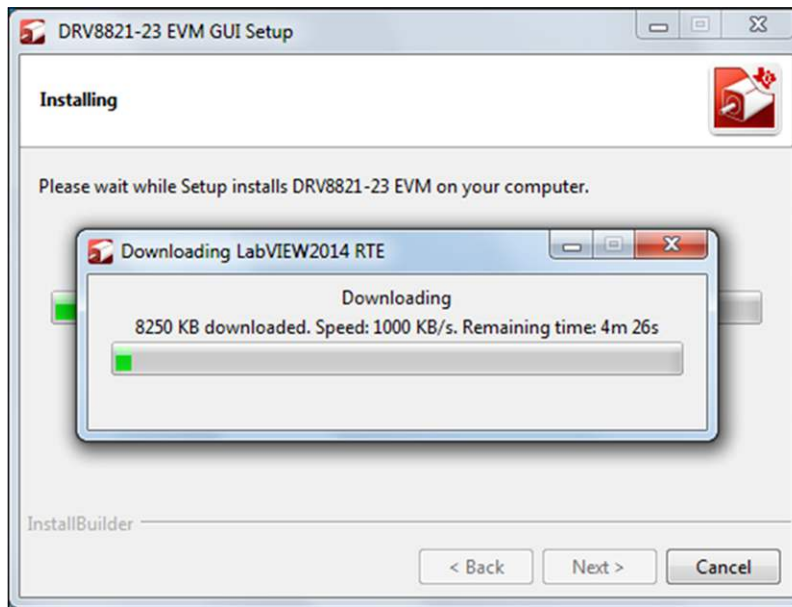

Figure 11. Downloading RTE

10. Once the Download completes, LabVIEW begins with the self-extraction as shown in [Figure 12](#).

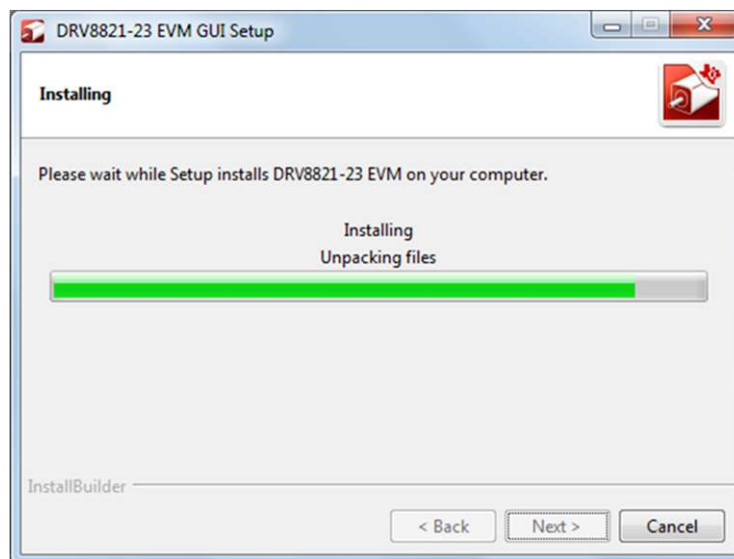

Figure 12. LabVIEW RTE Self Extraction

11. A screen appears as shown in [Figure 13](#). It initializes the LabVIEW RTE Installation.

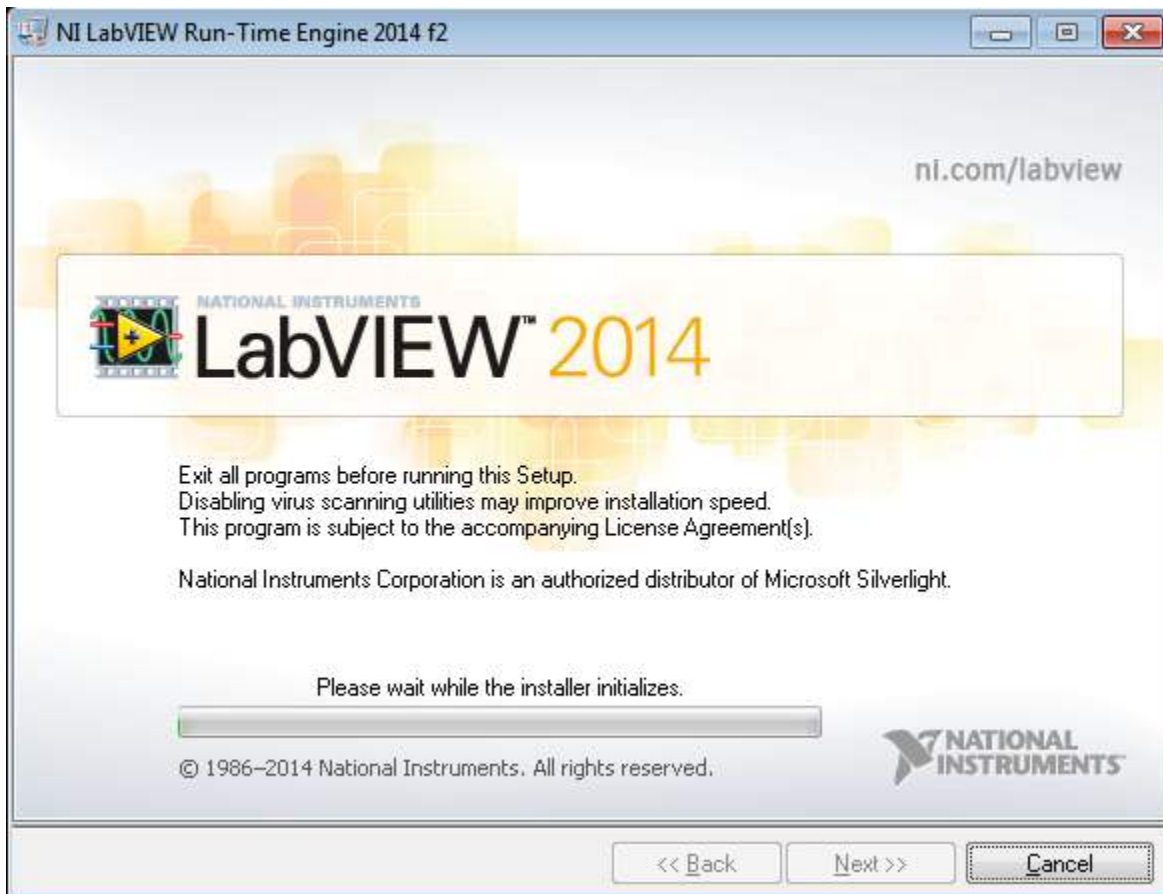

Figure 13. LabVIEW RTE Installation Initialization

12. A display as shown in [Figure 14](#) appears which indicates the progress of LabVIEW RTE installation.

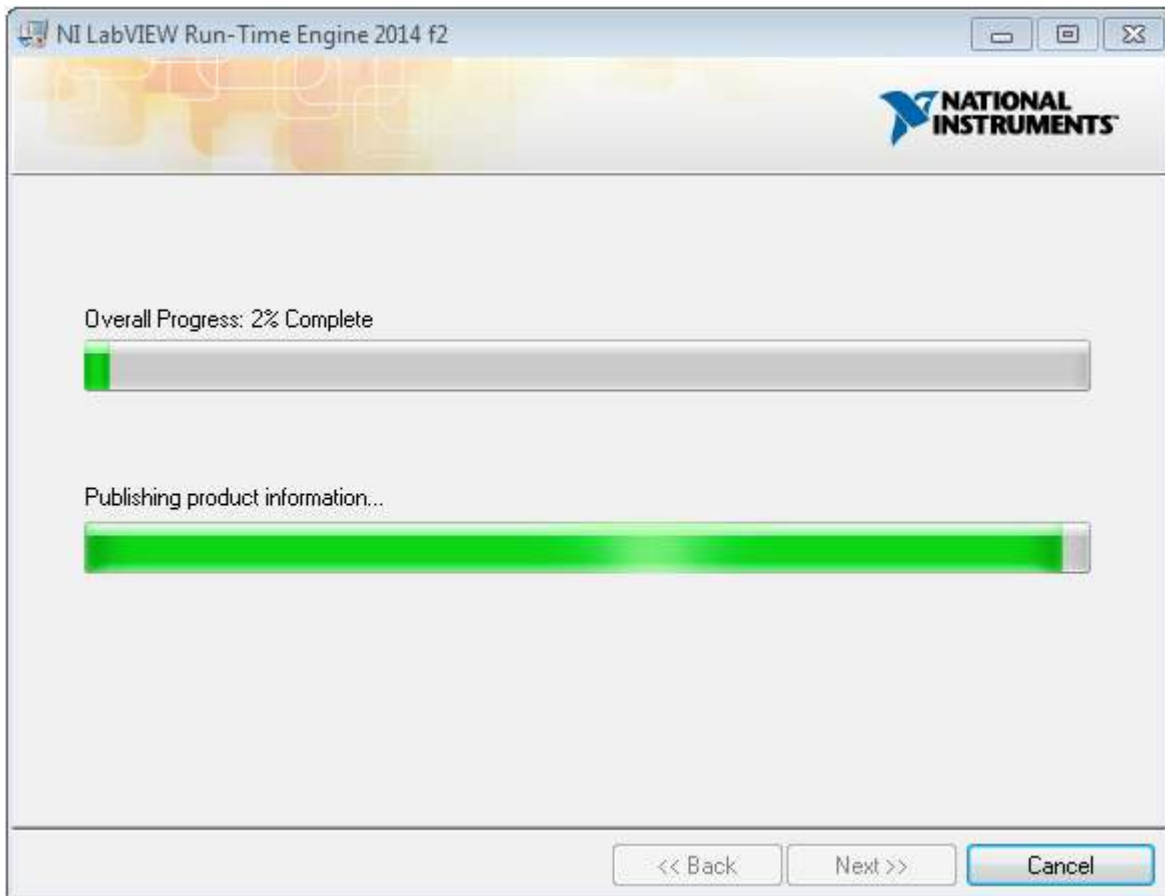

Figure 14. Installation of LabVIEW RTE in Progress

13. Once the LabVIEW RTE 2014 is installed, DRV 8821/DRV8823 EVM GUI component installs.
14. After DRV8821/DRV8823 Installation, FTDI Installation begins. A screen as shown in [Figure 15](#) appears, click **Extract** to proceed.

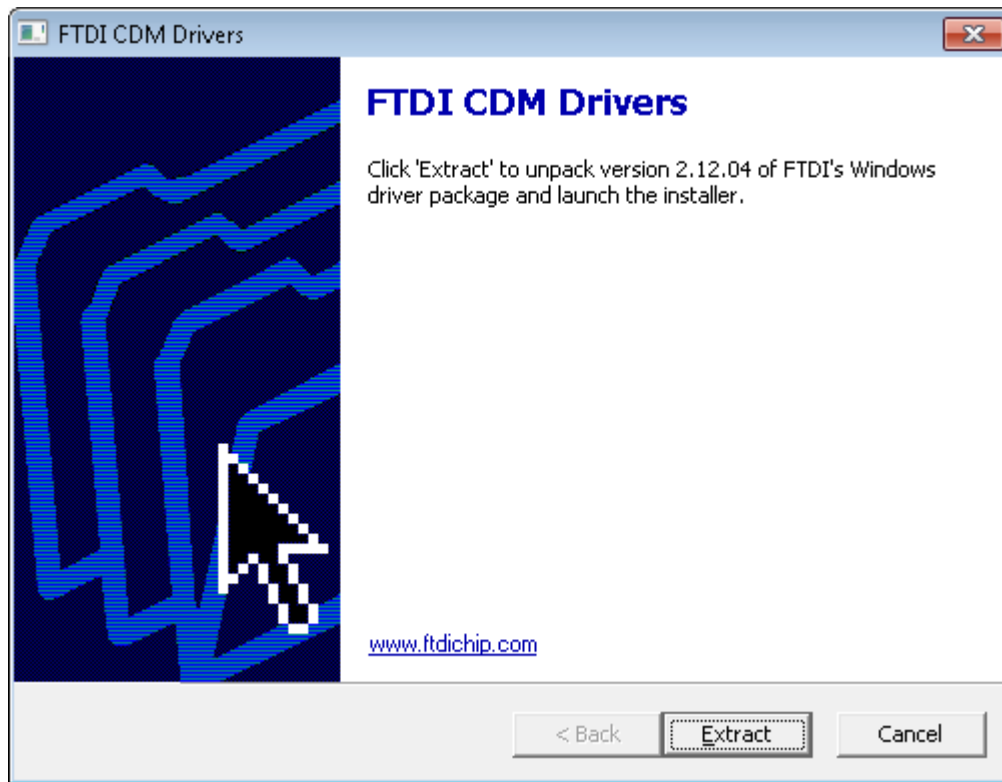

Figure 15. FTDI Installation Initialization

15. A screen as shown in Figure 16 appears, click **Next** to proceed.

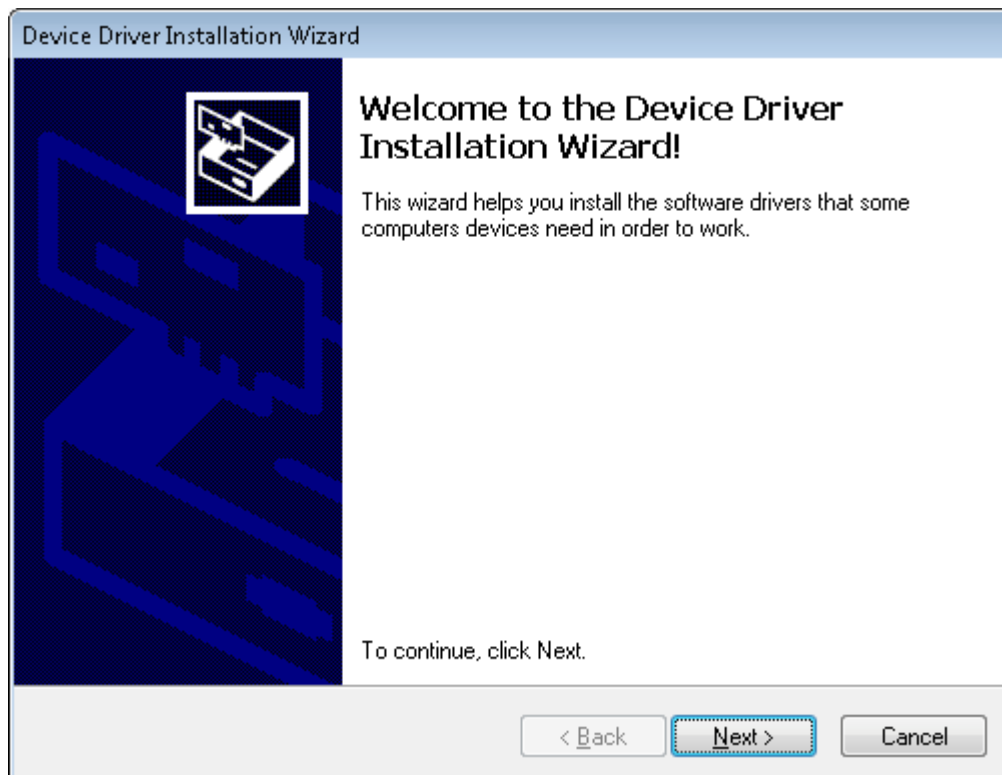

Figure 16. Driver Installation Wizard

16. The License Agreement appears on screen as shown in [Figure 17](#).
17. Read through the License Agreement carefully and enable the “I Accept this Agreement” radio button and Click on **Next**.

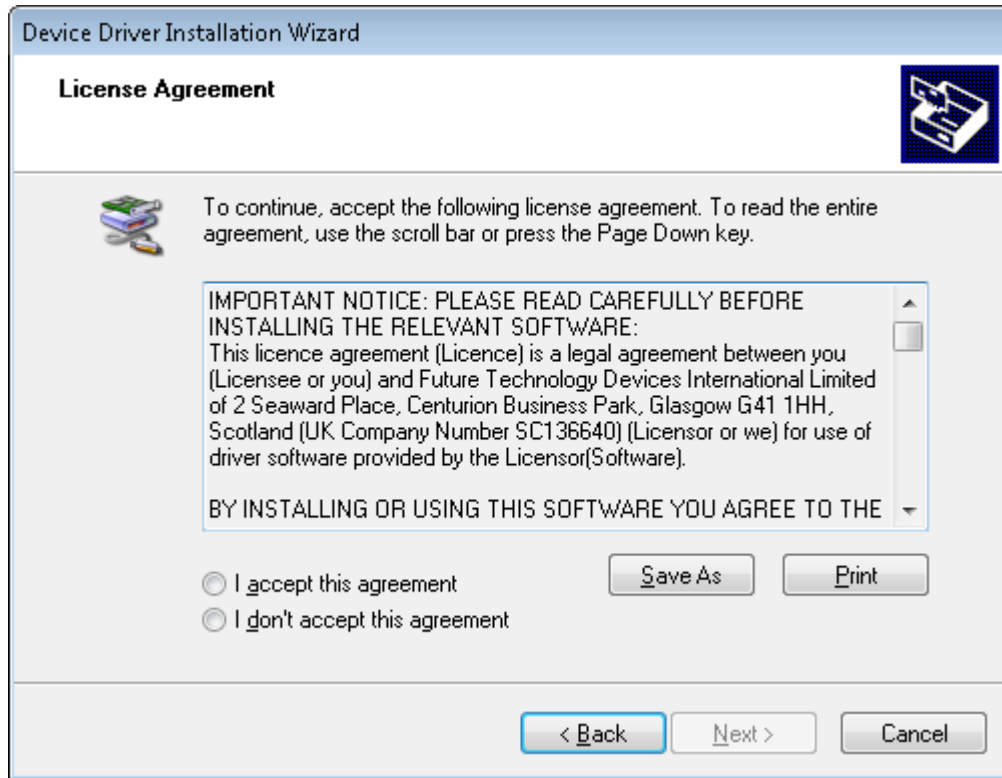

Figure 17. License Agreement for FTDI Driver

18. Click **Finish** to complete the Driver Installation.

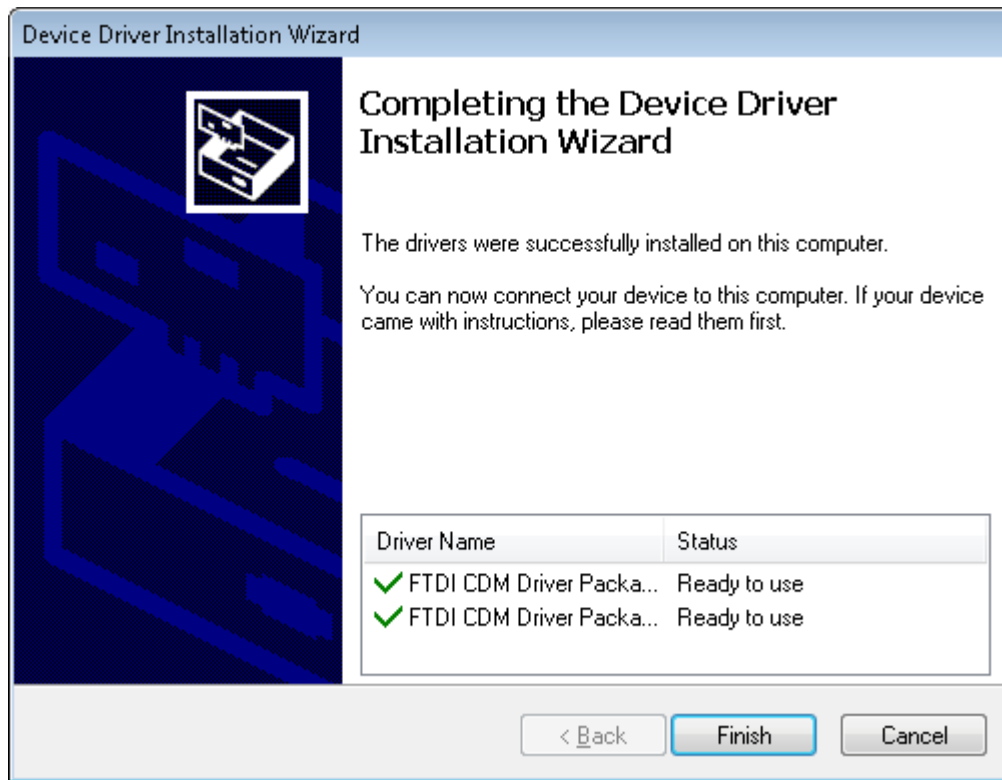

Figure 18. Driver Installation Completion

19. [Figure 19](#) appears denoting the completion of DRV8821/DRV8823 EVM GUI Installation. Click **Finish**.

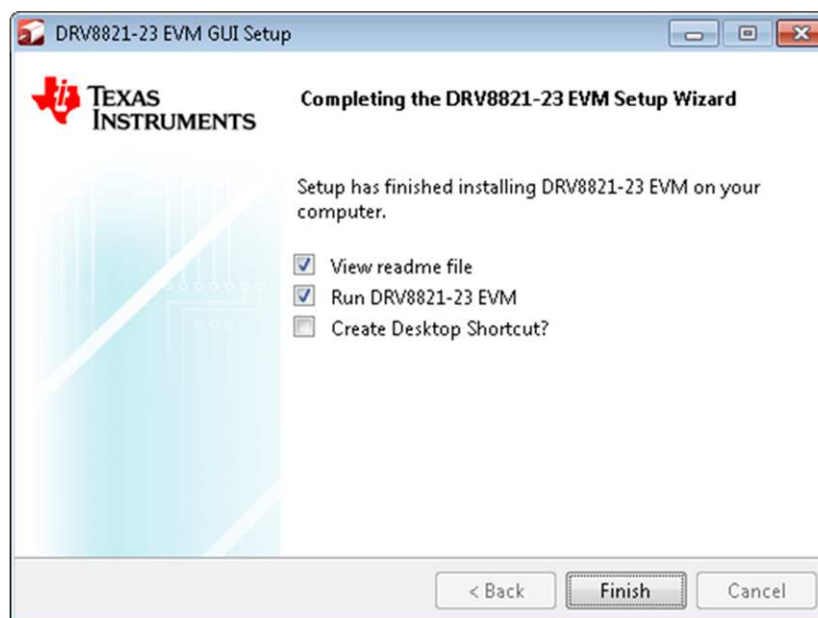

Figure 19. Installation Complete

20. A Readme window as shown in [Figure 20](#) appears displaying the link for LV 2014 RTE.

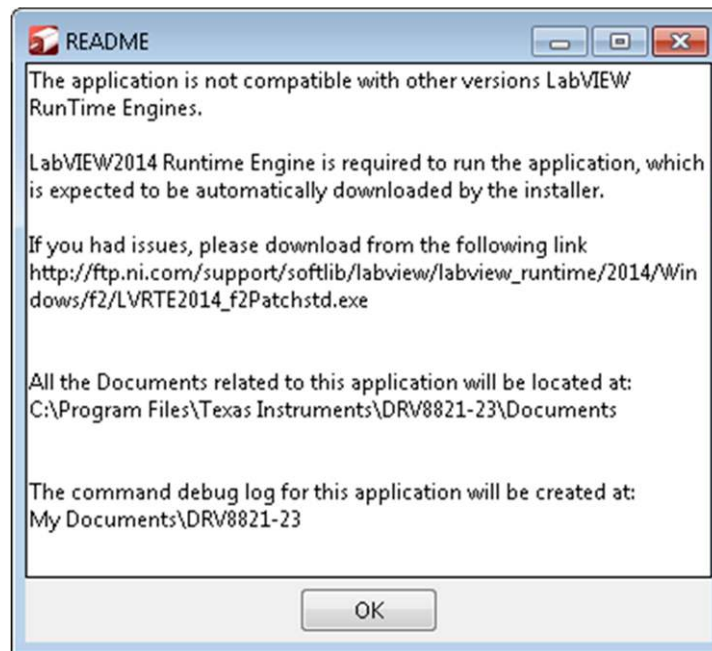

Figure 20. Readme Window

WARNING

The DRV8821/DRV8823 EVM GUI requires the LabVIEW Run-Time Engine 2014 to be installed before the GUI executes. Please note the application is not compatible with other versions of LabVIEW Runtime Engine.

You can download National Instruments LabVIEW Run-Time Engine 2014 from the below link:

[LabVIEW Run-Time Engine 2014](http://ftp.ni.com/support/softlib/labview/labview_runtime/2014/Windows/f2/LVRTE2014_f2Patchstd.exe)

NOTE: DRV8821/DRV8823 EVM GGUI executable has been built in LabVIEW 2014 (32-bit) version, and it expects the LabVIEW Run-Time Engine version to be LabVIEW Run-Time Engine (32-bit version).

3 The Windows Application

The CPG003_DRV8821-23EVM Windows application is the software counterpart for the CPG003_DRV8821-23EVM-001 EVM. It allows the PC computer to connect to the MSP430F1612 microcontroller through a USB interface chip. Once connection is established and commands are sent, the microcontroller takes care of configuring control signals and administering certain levels of automation, such as STEP generation (for DRV8821) or SPI communications (for DRV8823).

The graphical user interface (GUI) has been designed to allow for all of the DRV8821/DRV8823 device's functionality to be tested without having to intervene with the hardware, except for the proper configuration of jumpers, when needed.

Figure 21 and Figure 22 show the CPG003_DRV8821-23EVM-001_R1p0.exe main screen. The application is divided into two tabs: One for the DRV8821 and one for the DRV8823. The menu contains items to configure and enable/disable the serial port.

The DRV8821 tab contains frames with GPIO control for DRV8821's control signals, speed, acceleration and number of steps control for both stepper motors AB and CD, and current control through the microcontroller's DACs.

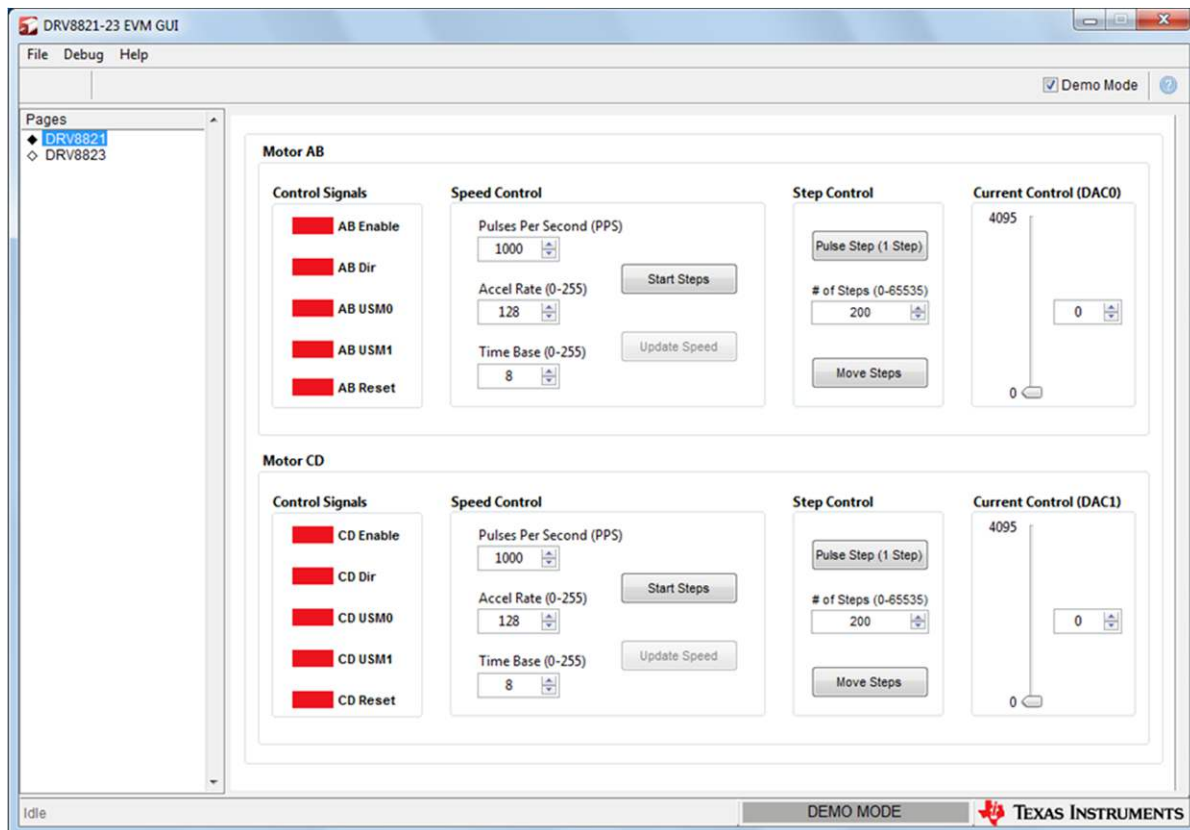

Figure 21. CPG003_DRV8821-23EVM-001_R1p0.exe Main Screen (DRV8821)

The DRV8823 tab contains two frames with the bits that make up the 16-bit serial registers which contain the control signals to properly articulate each motor. Also GPIO signals such as Reset and SLEEPn are made accessible through check boxes. Finally, two sliders adjust the reference voltage through the microcontroller's DAC outputs.

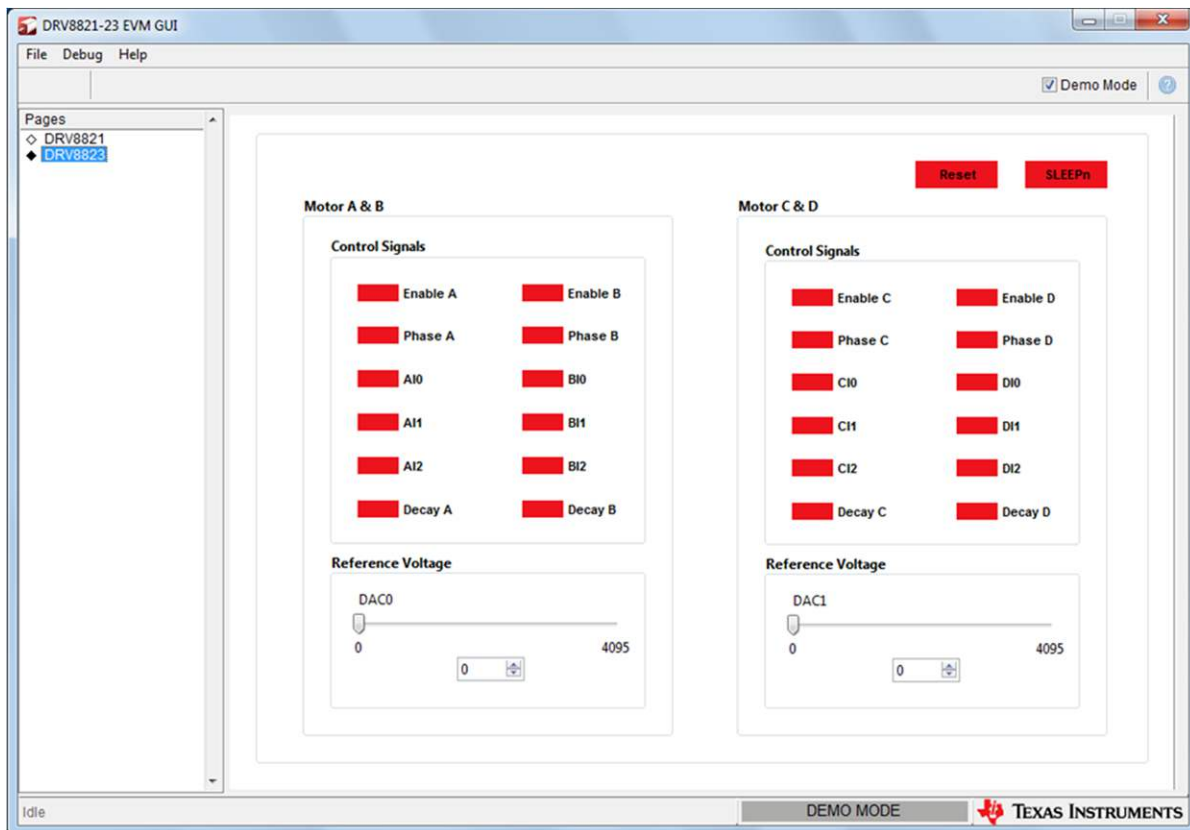

Figure 22. CPG003_DRV8821-23EVM-001_R1p0.exe Main Screen (DRV8823)

3.1 DRV8821 GPIO Control Signals

Once the application is communicating with the interface board, the control signals can be actuated by checking or un-checking check boxes on the Control Signals frame.

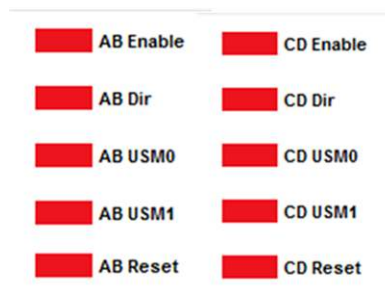

Figure 23. Control Signals Frame

A checked checkbox translates to a HI level on the respective control signal. Un-checked checkboxes translate to a LO level on the respective control signals.

3.2 Updating DAC Output for Current Control (VREF)

If the DRV8821 has been configured to accept VREF analog voltages through the microcontroller DAC outputs (refer to Jumpers section), then the slider bar on the Current Control frame can be used to set the VREF voltage.

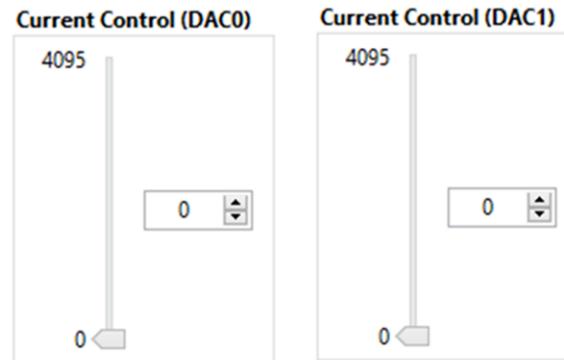

Figure 24. Current Control Frame

The 12-bit DAC channels, 0/1, are connected to the DRV8821/DRV8823 VREF analog inputs ABVREF and CDVREF. Changing the DAC digital value from 0 to 4095 changes the analog voltage at the respective VREF pin from 0 V to 2.5 V respectively, following [Equation 1](#).

$$VREF = DAC_VALUE \cdot \frac{2.5\text{ V}}{4095} \quad (1)$$

Where:

1. VREF is the output voltage.
2. DAC_VALUE is a number from 0 to 4095.

3.3 Operating the Stepper Motor (DRV8821)

3.3.1 Turning the Stepper Motor

The Windows application, in conjunction with the MSP430F1612 microcontroller, utilizes a series of timers to coordinate the rate of steps sent to the device. Once all the control signals are configured accordingly, (ENABLE_n = LO, SLEEP_n = HI, RESET_n = HI; DIR, USM0 and USM1 can be HI or LO depending on preferred mode of operation; SR_n must be L, if external diodes are not populated), the motor is ready to be turned.

The DRV8821-23EVM-001 customer EVM allows for the possibility of coordinating step rates such that accelerating and decelerating profiles are achieved. Both acceleration and deceleration are controlled by the same parameters, acceleration rate and time base.

When the motor starts, it always starts at the slowed PPS speed (62 pulses per second). The controller will accelerate the motor in order to reach the PPS speed. Acceleration rate is an 8-bit number (0 to 255) that gets added to the current PPS speed and time base is an 8-bit number (0 to 255) that specifies how many milliseconds will elapse from one speed increase to the next. Once the specified PPS has been achieved, the acceleration stops.

The inverse of the above described will command the motor to stop.

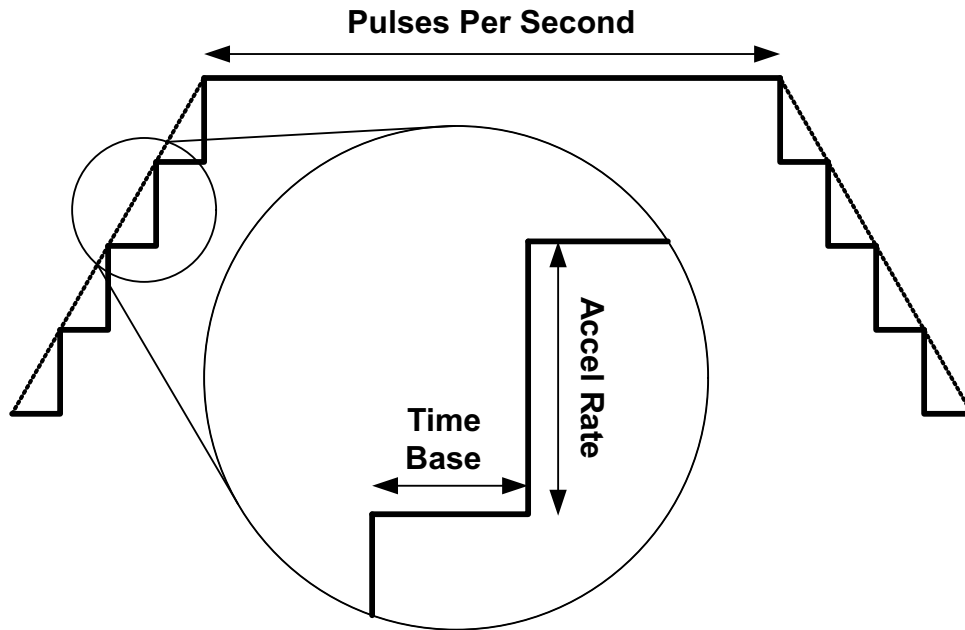

Figure 25. Turning the Stepper Motor

The Windows application frame to control speed, acceleration and deceleration, as well as motor start and stop is shown in [Figure 26](#).

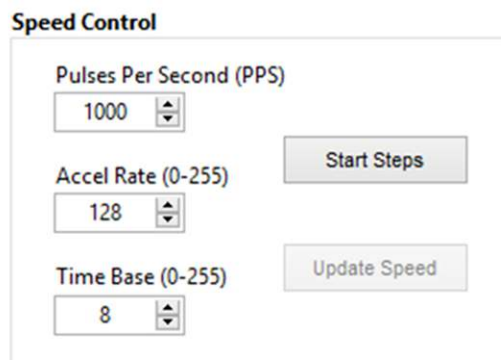

Figure 26. Speed control Frame

Pressing the “Start Steps” button, will start the timer and pulses will be generated at the rate specified by the decimal number at the PPS text box. Once the “Start Steps” button is pressed it becomes the “Stepping” button. Press the “Stepping” button to stop the stepper motion.

When the motor is stepping, the “Update Speed” button becomes enabled. Speed can be updated by modifying the PPS text box and then pressing the “Update Speed” button. The “Speed” button is disabled every time the motor is not turning because the stepping has been halted by pressing the “Stepping” button.

3.3.2 Step by Step control

The Step Control frame has a series of tools to control the stepping of the motor on a predetermined number of steps fashion.

The “Pulse Step” button allows for a single step to be issued. Remember that a STEP takes place when STEP goes from LO to HI.



Figure 27. Step Control Frame

To move the motor a number of steps and then stop, fill the "# of Steps" text box with a decimal number from 0 to 65535 and the motor will move that number of steps at the speed specified on the PPS text box. No acceleration or deceleration takes place under this function.

3.4 Operating the Motors (DRV8823)

The Windows application gives access to both serial registers on the DRV8823 bit by bit, very similar to the GPIO section on the DRV8821 tab. If the “Auto Update” checkbox is checked, checking any of the checkboxes on the respective frame, will update the serial register. If the “Auto Update” checkbox is unchecked, the button “Write Motor x” must be pressed for these bit states to be transmitted to the device.

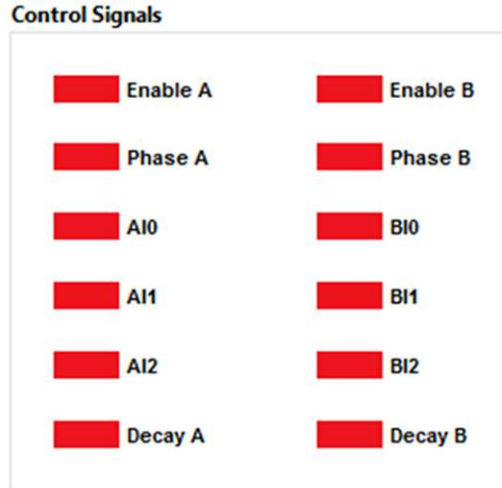

Figure 28. Motor A and B Frame

A checked checkbox translates to a 1 on the respective serial register bit. Un-checked checkboxes translates to a 0 on the respective serial register bits.

3.5 Updating DAC Output for Reference Voltage

If the DRV8823 has been configured to accept VREF analog voltages through the microcontroller's DAC outputs (refer to Jumpers section), then the slider bar on the Reference Voltage frame can be used to set the VREF voltage.

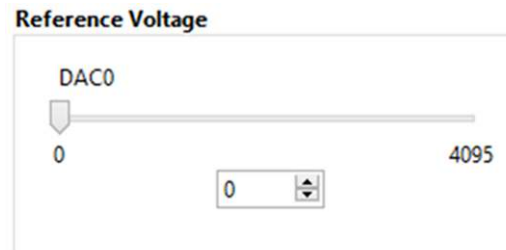

Figure 29. Reference Voltage Frame

The 12-bit DAC channels, 0/1, are connected to the DRV883 VREF analog inputs ABVREF and CDVREF. Changing the DAC digital value from 0 to 4095 changes the analog voltage at the respective VREF pin from 0 V to 2.5 V respectively, following [Equation 2](#).

$$VREF = DAC_VALUE \cdot \frac{2.5 V}{4095} \quad (2)$$

Where:

1. VREF is the output voltage.
2. DAC_VALUE is a number from 0 to 4095.

4 Menu Options

- File - The File menu contains the option Exit as shown in [Figure 30](#) below.

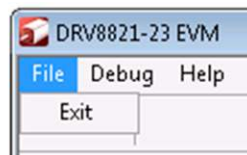

Figure 30. File Menu

- Debug - The Debug option can be used for the following operations.

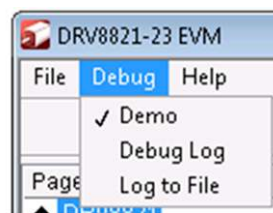

Figure 31. Debug Menu

- - Demo - By selecting the Demo in the submenu, the GUI runs in simulation mode, and by unselecting it, the GUI runs in connected mode.
 - Log to File - The log to file submenu is used to log the GUI activities to a log file that is specified.
 - Debug log - The Debug log option enables to log all the activities of the user. If that is not selected, only the high-level operations log.
- Help
 - Clicking the About in the Help Menu

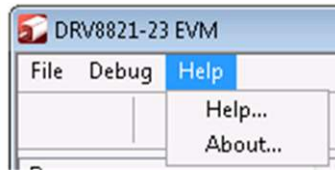

Figure 32. Help Menu

- The About Page provides the details like the Name of the GUI, GUI version, Supported OS and Copyright Information.



Figure 33. About Page

IMPORTANT NOTICE AND DISCLAIMER

TI PROVIDES TECHNICAL AND RELIABILITY DATA (INCLUDING DATA SHEETS), DESIGN RESOURCES (INCLUDING REFERENCE DESIGNS), APPLICATION OR OTHER DESIGN ADVICE, WEB TOOLS, SAFETY INFORMATION, AND OTHER RESOURCES "AS IS" AND WITH ALL FAULTS, AND DISCLAIMS ALL WARRANTIES, EXPRESS AND IMPLIED, INCLUDING WITHOUT LIMITATION ANY IMPLIED WARRANTIES OF MERCHANTABILITY, FITNESS FOR A PARTICULAR PURPOSE OR NON-INFRINGEMENT OF THIRD PARTY INTELLECTUAL PROPERTY RIGHTS.

These resources are intended for skilled developers designing with TI products. You are solely responsible for (1) selecting the appropriate TI products for your application, (2) designing, validating and testing your application, and (3) ensuring your application meets applicable standards, and any other safety, security, regulatory or other requirements.

These resources are subject to change without notice. TI grants you permission to use these resources only for development of an application that uses the TI products described in the resource. Other reproduction and display of these resources is prohibited. No license is granted to any other TI intellectual property right or to any third party intellectual property right. TI disclaims responsibility for, and you will fully indemnify TI and its representatives against, any claims, damages, costs, losses, and liabilities arising out of your use of these resources.

TI's products are provided subject to [TI's Terms of Sale](#) or other applicable terms available either on ti.com or provided in conjunction with such TI products. TI's provision of these resources does not expand or otherwise alter TI's applicable warranties or warranty disclaimers for TI products.

TI objects to and rejects any additional or different terms you may have proposed.

Mailing Address: Texas Instruments, Post Office Box 655303, Dallas, Texas 75265
Copyright © 2022, Texas Instruments Incorporated