

# 183 SERIES INDICATOR LIGHTS

Caps Ordered Separately, See Below

PART NO.	CAP	FIG
183-9730-14-602	ALL	1
183-9830-14-604	ALL	2

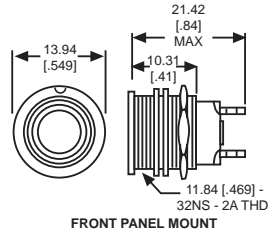

Fig. 1

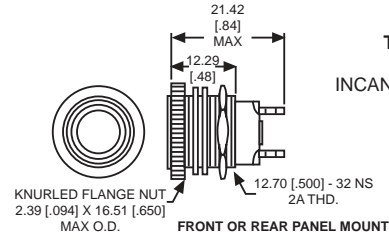

Fig. 2

Uses:  
T-1 3/4 MIDGET  
FLANGE BASE  
INCANDESCENT LAMP

# 184, 186, 187, 188, 302, 304, 305 & 307 SERIES CAPS

## 1/2" SQUARE

CAP PART NO.	COLOR	FIG
184-1871	RED	3
184-1872	GREEN	3
184-1873	YELLOW	3
184-1875	WHITE	3

## 1/2" ROUND

CAP PART NO.	COLOR	FIG
186-1471	RED	7
186-1472	GREEN	7
186-1473	YELLOW	7
186-1475	WHITE	7

## 5/8" SQUARE†

CAP PART NO.	COLOR	FIG
304-1871	RED	4
304-1872	GREEN	4
304-1873	YELLOW	4
304-1875	WHITE	4

## 5/8" ROUND†

CAP PART NO.	COLOR	FIG
305-1471	RED	8
305-1472	GREEN	8
305-1473	YELLOW	8
305-1475	WHITE	8

## 3/4" SQUARE

CAP PART NO.	COLOR	FIG
187-1871	RED	5
187-1872	GREEN	5
187-1873	YELLOW	5
187-1875	WHITE	5

## 3/4" ROUND

CAP PART NO.	COLOR	FIG
188-1471	RED	9
188-1472	GREEN	9
188-1473	YELLOW	9
188-1475	WHITE	9

## 3/4" SQUARE†

CAP PART NO.	COLOR	FIG
307-1871	RED	6
307-1872	GREEN	6
307-1873	YELLOW	6
307-1875	WHITE	6

## 3/4" x 1" RECTANGULAR†

CAP PART NO.	COLOR	FIG
302-3471	RED	10
302-3472	GREEN	10
302-3473	YELLOW	10
302-3475	WHITE	10

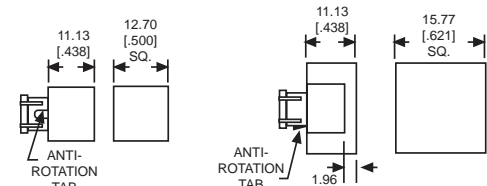

Fig. 3

Fig. 4

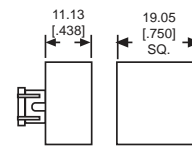

Fig. 5

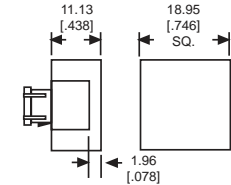

Fig. 6

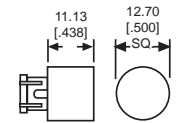

Fig. 7

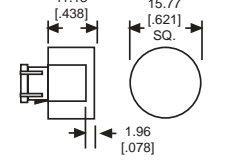

Fig. 8

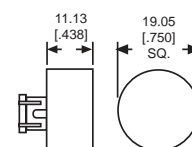

Fig. 9

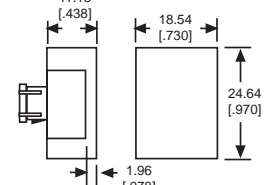

Fig. 10

Please contact factory for legend information available on Figures 3 thru 10

# 534 SERIES CAP KITS

## 3/4" x 1" LEGEND KITS†

KIT PART NO.	LENS/FILTER COLOR	FIG
534-0701-030	RED, GREEN, AMBER, BLUE/NONE	11
534-0701-037	CLEAR/NONE	11
534-0701-537	CLEAR/RED, GREEN, AMBER, BLUE	11

Legends provided by Dialight Stocking Distributors

† Feature fingertip grip for use with snap-in mount switches and indicators

Material & Finish: Base, Clear anodized aluminum;  
Cap, High temperature scratch-resistant plastic

Neon and incandescent lamp information on Pages 35 and 36.

Dimensions in mm [inches]

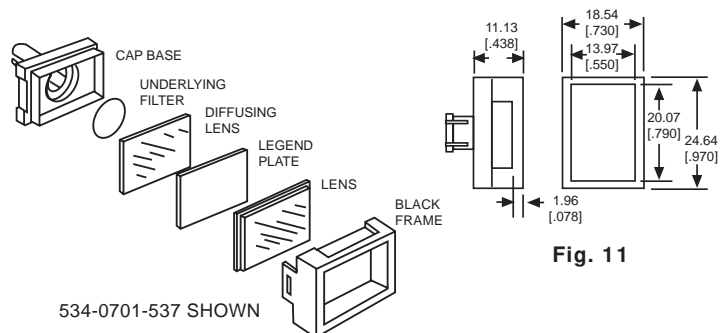

Fig. 11

534-0701-537 SHOWN