

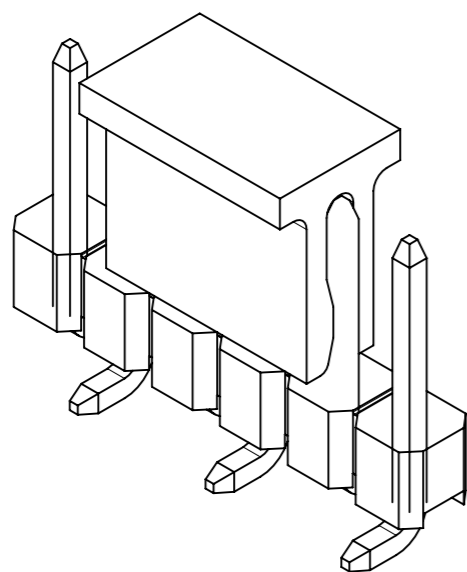

RECOMMENDED PCB LAYOUT: COMPONENT SIDE

NOTES:

- MATERIAL:
HSG: NYLON, GLASS-FILLED, UL94V-0, COLOR: BLACK
CAP: NYLON, GLASS-FILLED, UL94V-0, COLOR: BLACK
PIN: 0.64MM SQ, COPPER ALLOY
- PLATING TYPE:
(1) GOLD FLASH OVER
1.25µm MIN. NICKEL OVERALL.
(2) GOLD FLASH ON CONTACT AND
2.50µm MIN. TIN ON SOLDER TAIL OVER
1.25µm MIN. NICKEL OVERALL.
(4) 0.38µm MIN. GOLD PLATE ON CONTACT AND
2.00µm MIN. TIN ON SOLDER TAIL OVER
1.25µm MIN. NICKEL OVERALL.
(5) 0.75µm MIN. GOLD PLATE ON CONTACT AND
2.00µm MIN. TIN ON SOLDER TAIL OVER
1.25µm MIN. NICKEL OVERALL.
(6) 2.50µm MIN. TIN OVERALL
1.25µm MIN. NICKEL OVERALL
- PRODUCT SPECIFICATION: PS-87920-019
- PACKAGING TYPE: SEE TABLE
- PACKAGING SPEC:
TUBE WITH CAP VERSION: PK-89990-558
TUBE W/O CAP VERSION: PK-89990-545
TRAY W/O CAP: PK-89990-489
EMBOSS TAPE WITH CAP: PK-89990-486 AND PK-87898-400
- WAFER TO BE FLAT WITHIN 0.003 mm/mm
- BEND DEPRESSION IS ACCEPTED SO LONG AS IT DOES NOT AFFECT THE OVERALL COPLANARITY OF TAIL
- COPLANARITY IS TO BE MEASURED BY RESTING THE SOLDER TAIL ON A FLAT SURFACE
- IRREGULAR CIRCUIT CUTOFF WITHIN BREAKAWAY SECTION IS PERMISSIBLE. CUTTING OR CHIPPING OF THE MAIN BODY IS NOT ACCEPTABLE
- CAP LOCATION IS CENTERED ALONG THE MATING ENDS AS SHOWN. TOP SURFACE OF CAP TO BE FLAT FOR THE PURPOSE OF PICK & PLACE BY VACUUM SUCTION NOZZLE
- RECOMMENDED PCB THICKNESS IS 1.60mm±0.10
- THE ABOVE CKT 6 IS FOR ILLUSTRATION PURPOSE ONLY
- TUBE LENGTH AS PER STANDARD 560mm

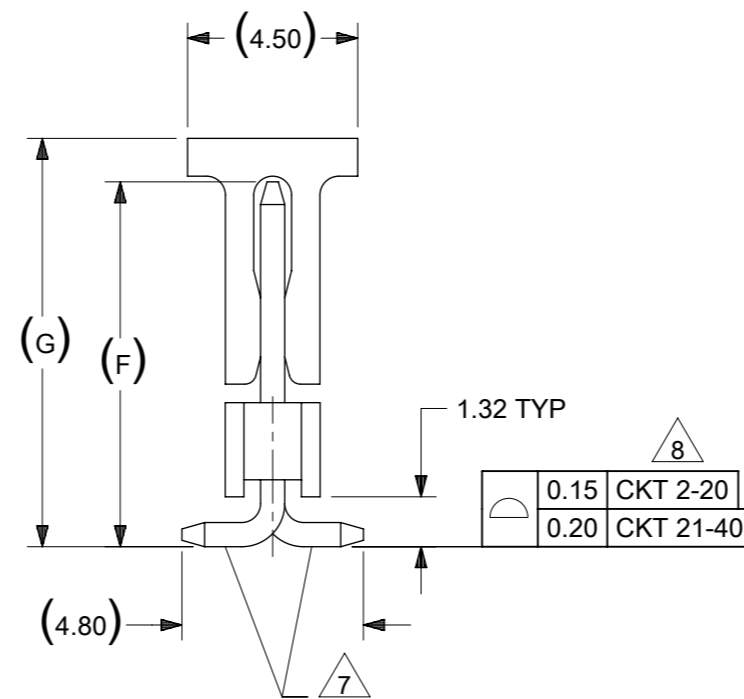
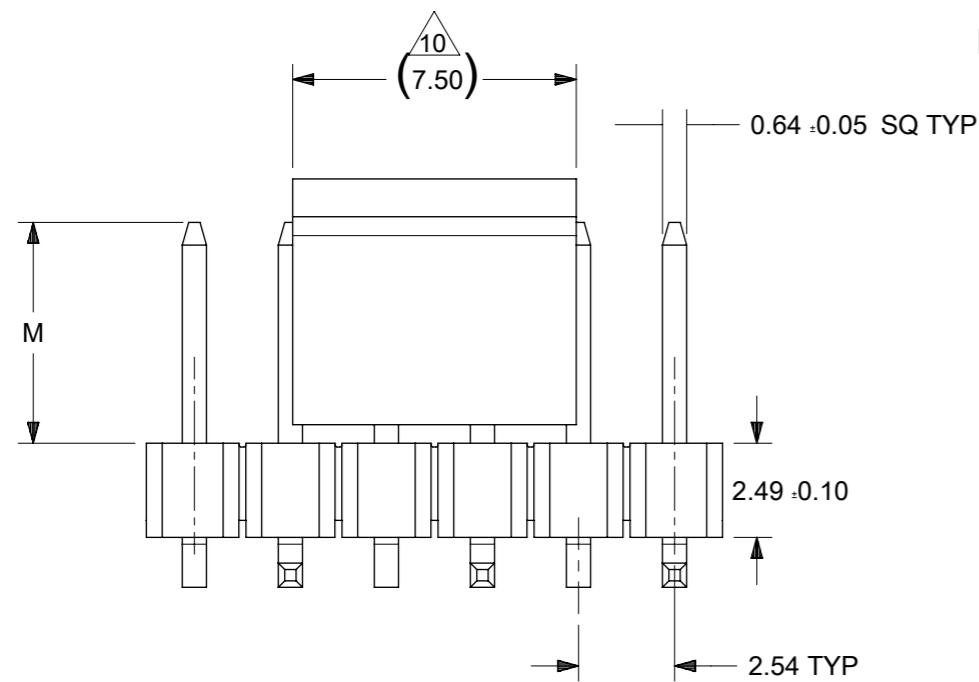

THIS DRAWING CONTAINS INFORMATION THAT IS PROPRIETARY TO MOLEX ELECTRONIC TECHNOLOGIES, LLC AND SHOULD NOT BE USED WITHOUT WRITTEN PERMISSION									
DIMENSION UNITS		SCALE		CURRENT REV DESC:					
mm		NTS		<p>molex</p> <p>CUSTOM HEADER 2.54MM PITCH SINGLE ROW SINGLE WAFER SMT HEADER</p> <p>PRODUCT CUSTOMER DRAWING</p> <p>DOCUMENT NUMBER: SD-87898-001 DOC TYPE: PSD DOC PART: 000 REVISION: B26</p> <p>DRAWING: A3-SIZE SERIES: 87898 MATERIAL NUMBER: SEE TABLE CUSTOMER: GENERAL MARKET SHEET NUMBER: 1 OF 21</p>					
GENERAL TOLERANCES (UNLESS SPECIFIED)									
		MM	INCH						
4 PLACES	±								
3 PLACES	±								
2 PLACES	±	0.2							
1 PLACE	±								
0 PLACES	±								
ANGULAR TOL		± 3.0°		EC NO: 745488		DRWN: SUIFR		2023/02/15	
				CHK'D: SUIFR		APPR: MRAMAKRISHNA		2023/04/10	
DRAFT WHERE APPLICABLE MUST REMAIN WITHIN DIMENSIONS		THIRD ANGLE PROJECTION		DRWN: GGUNAGI		APPR: ISHWARG		2016/11/09	
				SERIES		MATERIAL NUMBER		CUSTOMER	
				A3-SIZE		87898		GENERAL MARKET	

PACKAGING OPTION PART NO.						CKT SIZE	VOID POSITION	PLATING TYPE	DIMENSION					CAP (SEE SHEET-16)
TRAY WITHOUT CAP	TRAY WITH CAP	TUBE WITHOUT CAP	TUBE WITH CAP	TAPE & REEL WITHOUT CAP	TAPE & REEL WITH CAP				A	B	G	F	M	
87898-0301	-----	-----	-----	-----	-----	3	----	1	7.62	5.08	10.81	9.65	5.84	1
87898-0302	-----	-----	-----	-----	-----	3	----	2	7.62	5.08	10.81	9.65	5.84	1
87898-0304	-----	-----	-----	-----	87898-0314	3	----	4	7.62	5.08	10.81	9.65	5.84	1
87898-0305	-----	-----	-----	-----	87898-0315	3	----	5	7.62	5.08	10.81	9.65	5.84	1
87898-0306	-----	-----	-----	-----	87898-0316	3	----	6	7.62	5.08	10.81	9.65	5.84	1
87898-0307	-----	-----	-----	-----	87898-0320	3	----	6	7.62	5.08	10.81	9.65	5.84	1
-----	-----	-----	-----	-----	87898-0317	3	-----	6	7.62	5.08	10.81	9.65	5.84	1
-----	-----	-----	-----	-----	87898-0321	3	-----	6	7.62	5.08	10.81	9.65	5.84	1
-----	-----	-----	-----	-----	87898-0318	3	----	5	7.62	5.08	10.81	9.65	5.84	1
-----	-----	-----	-----	-----	87898-0310	3	-----	6	7.62	5.08	14.91	13.91	10.10	1
-----	-----	-----	-----	-----	87898-0309	3	-----	6	7.62	5.08	14.81	13.81	10.00	1
-----	-----	87898-0370	-----	-----	-----	3	-----	6	7.62	5.08	----	13.91	10.10	1

REFER TO LAST SHEET FOR 2CKT SIZE

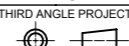
THIS DRAWING CONTAINS INFORMATION THAT IS PROPRIETARY TO MOLEX ELECTRONIC TECHNOLOGIES, LLC AND SHOULD NOT BE USED WITHOUT WRITTEN PERMISSION																	
DIMENSION UNITS		SCALE		CURRENT REV DESC:													
mm		NTS															
GENERAL TOLERANCES (UNLESS SPECIFIED)				EC NO: 745488 DRWN: SUAIFR 2023/02/15 CHK'D: SUAIFR 2023/04/10 APPR: MRAMAKRISHNA 2023/04/10 INITIAL REVISION: DRWN: GGUNAGI 2016/11/09 APPR: ISHWARG 2016/12/06										CUSTOM HEADER			
										2.54MM PITCH SINGLE ROW SINGLE WAFER SMT HEADER							
										PRODUCT CUSTOMER DRAWING							
4 PLACES ±		±								DOCUMENT NUMBER				SD-87898-001		DOC TYPE	
3 PLACES ±		±								REVISION				PSD		000 B26	
2 PLACES ±		0.2 ±		MATERIAL NUMBER				SEE TABLE		CUSTOMER							
1 PLACE ±		±		SERIES				A3-SIZE		87898							
0 PLACES ±		±		SHEET NUMBER				GENERAL MARKET		2 OF 21							
ANGULAR TOL ± 3.0°				THIRD ANGLE PROJECTION		DRAWING		SERIES		MATERIAL NUMBER							
DRAFT WHERE APPLICABLE MUST REMAIN WITHIN DIMENSIONS						A3-SIZE		87898		SEE TABLE							

DOCUMENT STATUS	P1	RELEASE DATE	2023/04/10	07:46:21
-----------------	----	--------------	------------	----------

10		9		8		7		6		5		4		3		2		1	
PACKAGING OPTION PART NO.						CKT SIZE	VOID POSITION	PLATING TYPE	MODIFIED MATING CKT	MODIFIED MATING LENGTH	DIMENSION					CAP (SEE SHEET-16)			
TRAY WITHOUT CAP	TRAY WITH CAP	TUBE WITHOUT CAP	TUBE WITH CAP	TAPE & REEL WITHOUT CAP	TAPE & REEL WITH CAP						A	B	G	F	M				
F	-----	-----	87898-0421	87898-0431	-----	87898-0451	4	-----	1	-----	-----	10.16	7.62	10.81	9.65	5.84	1		
	-----	-----	87898-0422	87898-0432	-----	87898-0452	4	-----	2	-----	-----	10.16	7.62	10.81	9.65	5.84	1		
	-----	-----	87898-0424	87898-0434	-----	87898-0454	4	-----	4	-----	-----	10.16	7.62	10.81	9.65	5.84	1		
	-----	-----	87898-0425	87898-0435	-----	87898-0455	4	-----	5	-----	-----	10.16	7.62	10.81	9.65	5.84	1		
	-----	-----	87898-0426	87898-0436	-----	87898-0456	4	-----	6	-----	-----	10.16	7.62	10.81	9.65	5.84	1		
	-----	-----	87898-0428	87898-0437	-----	87898-0460	4	-----	6	-----	-----	10.16	7.62	10.81	9.65	5.84	1		
	-----	-----	-----	-----	-----	87898-0457	4	-----	6	-----	-----	10.16	7.62	10.81	9.65	5.84	1		
	-----	-----	-----	-----	-----	87898-0458	4	-----	5	-----	-----	10.16	7.62	10.81	9.65	5.84	1		
	-----	-----	-----	-----	-----	87898 - 0480	4	CKT# 4	5	-----	-----	10.16	7.62	14.70	13.65	9.84	1		
	-----	-----	-----	-----	-----	87898 - 0481	4	-----	5	CKT # 1, 2 & 3	1.00	10.16	7.62	17.70	16.65	12.84	1		
E	87898 - 0482	-----	-----	-----	-----	-----	4	-----	---	CKT # 1, 2 & 3	1.00	10.16	7.62	---	16.65	12.84	1		
	-----	-----	-----	-----	-----	87898 - 0483	4	-----	---	CKT # 1, 2 & 3	1.00	10.16	7.62	14.70	13.65	9.84	1		
	-----	-----	87898-0427	-----	-----	-----	4	-----	---	-----	-----	10.16	7.62	---	11.87	8.06	1		
	-----	-----	-----	-----	-----	87898 - 0488	4	-----	5	-----	-----	10.16	7.62	17.78	16.74	12.93	1		
	-----	-----	87898-0521	87898-0531	-----	87898-0551	5	-----	1	-----	-----	12.70	10.16	10.81	9.65	5.84	1		
	-----	-----	87898-0522	87898-0532	-----	87898-0552	5	-----	2	-----	-----	12.70	10.16	10.81	9.65	5.84	1		
	-----	-----	87898-0524	87898-0534	-----	87898-0554	5	-----	4	-----	-----	12.70	10.16	10.81	9.65	5.84	1		
	-----	-----	87898-0525	87898-0535	-----	87898-0555	5	-----	5	-----	-----	12.70	10.16	10.81	9.65	5.84	1		
D	-----	-----	87898-0526	87898-0536	87898-0583	87898-0556	5	-----	6	-----	-----	12.70	10.16	10.81	9.65	5.84	1		
	-----	-----	87898-0528	87898-0538	87898-0584	87898-0558	5	-----	6	-----	-----	12.70	10.16	10.81	9.65	5.84	1		
	87898-0581	-----	-----	-----	-----	-----	5	-----	4	-----	-----	12.70	10.16	---	24.18	20.25	1		
	-----	-----	-----	-----	-----	87898-0576	5	-----	5	-----	-----	12.70	10.16	14.35	13.31	9.50	1		
	-----	-----	87898-0621	87898-0631	-----	87898-0651	6	-----	1	-----	-----	15.24	12.70	10.81	9.65	5.84	1		
	-----	-----	87898-0622	87898-0632	-----	87898-0652	6	-----	2	-----	-----	15.24	12.70	10.81	9.65	5.84	1		
	-----	-----	87898-0624	87898-0634	-----	87898-0654	6	-----	4	-----	-----	15.24	12.70	10.81	9.65	5.84	1		
	-----	-----	87898-0625	87898-0635	-----	87898-0655	6	-----	5	-----	-----	15.24	12.70	10.81	9.65	5.84	1		
C	-----	-----	87898-0626	87898-0636	-----	87898-0656	6	-----	6	-----	-----	15.24	12.70	10.81	9.65	5.84	1		
	-----	-----	87898-0628	87898-0638	-----	87898-0658	6	-----	6	-----	-----	15.24	12.70	10.81	9.65	5.84	1		
	87898-0607	-----	-----	-----	-----	87898-0657	6	-----	6	-----	-----	15.24	12.70	16.47	15.31	11.50	1		
	-----	-----	-----	-----	-----	87898-0605	6	-----	5	-----	-----	15.24	12.70	12.98	11.94	8.13	1		
	-----	-----	87898-0604	-----	-----	-----	6	-----	5	-----	-----	15.24	12.70	---	13.31	9.50	1		

A		B		C		D		E		F		1		2		3		4		5		6		7		8		9	
A		B		C		D		E		F		1		2		3		4		5		6		7		8		9	
A		B		C		D		E		F		1		2		3		4		5		6		7		8		9	

THIS DRAWING CONTAINS INFORMATION THAT IS PROPRIETARY TO MOLEX ELECTRONIC TECHNOLOGIES, LLC AND SHOULD NOT BE USED WITHOUT WRITTEN PERMISSION													
DIMENSION UNITS		SCALE		CURRENT REV DESC:									
mm		NTS		<p>molex</p> <p>CUSTOM HEADER 2.54MM PITCH SINGLE ROW SINGLE WAFER SMT HEADER</p> <p>PRODUCT CUSTOMER DRAWING</p> <p>DOCUMENT NUMBER: SD-87898-001 DOC TYPE: PSD DOC PART: 000 REVISION: B26</p> <p>EC NO: 745488 DRWN: SUAIFR 2023/02/15 CHK'D: SUAIFR 2023/04/10 APPR: MRAMAKRISHNA 2023/04/10</p> <p>INITIAL REVISION: DRWN: GGUNAGI 2016/11/09 APPR: ISHWARG 2016/12/06</p> <p>DRAFT WHERE APPLICABLE MUST REMAIN WITHIN DIMENSIONS</p> <p>THIRD ANGLE PROJECTION</p> <p>DRAWING: A3-SIZE SERIES: 87898 MATERIAL NUMBER: SEE TABLE CUSTOMER: GENERAL MARKET SHEET NUMBER: 3 OF 21</p>									
GENERAL TOLERANCES (UNLESS SPECIFIED)													
		MM										INCH	
4 PLACES	±		±										
3 PLACES	±		±										
2 PLACES	±	0.2	±										
1 PLACE	±		±										
0 PLACES	±		±										
ANGULAR TOL ± 3.0°													

10		9		8		7		6		5		4		3		2		1	
PACKAGING OPTION PART NO.						CKT SIZE	VOID POSITION	PLATING TYPE	DIMENSION					CAP (SEE SHEET-16)					
TRAY WITHOUT CAP	TRAY WITH CAP	TUBE WITHOUT CAP	TUBE WITH CAP	TAPE & REEL WITHOUT CAP	TAPE & REEL WITH CAP				A	B	G	F	M						
-----	-----	87898-0721	87898-0731	-----	87898-0751	7	-----	1	17.78	15.24	10.81	9.65	5.84	1					
-----	-----	87898-0722	87898-0732	-----	87898-0752	7	-----	2	17.78	15.24	10.81	9.65	5.84	1					
-----	-----	87898-0724	87898-0734	-----	87898-0754	7	-----	4	17.78	15.24	10.81	9.65	5.84	1					
-----	-----	87898-0725	87898-0735	-----	87898-0755	7	-----	5	17.78	15.24	10.81	9.65	5.84	1					
-----	-----	87898-0726	87898-0736	-----	87898-0756	7	-----	6	17.78	15.24	10.81	9.65	5.84	1					
-----	-----	87898-0727	87898-0737	-----	87898-0758	7	-----	6	17.78	15.24	10.81	9.65	5.84	1					
-----	-----	-----	-----	87898-0757	-----	7	-----	6	17.78	15.24	---	9.65	5.84	1					
-----	-----	-----	-----	87898-0759	-----	7	-----	6	17.78	15.24	---	9.65	5.84	1					
-----	-----	87898-0720	-----	-----	-----	7	-----	5	17.78	15.24	---	9.81	6.00	1					
-----	-----	87898-0767	-----	-----	-----	7	-----	5	17.78	15.24	---	13.81	10.00	1					
-----	-----	87898-0821	87898-0831	-----	87898-0851	8	-----	1	20.32	17.78	10.81	9.65	5.84	1					
-----	-----	87898-0822	87898-0832	-----	87898-0852	8	-----	2	20.32	17.78	10.81	9.65	5.84	1					
-----	-----	87898-0824	87898-0834	-----	87898-0854	8	-----	4	20.32	17.78	10.81	9.65	5.84	1					
-----	-----	87898-0825	87898-0835	-----	87898-0855	8	-----	5	20.32	17.78	10.81	9.65	5.84	1					
-----	-----	87898-0826	87898-0836	-----	87898-0856	8	-----	6	20.32	17.78	10.81	9.65	5.84	1					
-----	-----	87898-0827	87898-0837	-----	87898-0857	8	-----	6	20.32	17.78	10.81	9.65	5.84	1					
87898-0881	-----	-----	-----	-----	-----	8	-----	4	20.32	17.78	---	21.84	17.91	1					
-----	-----	87898-0921	87898-0931	-----	87898-0951	9	-----	1	22.86	20.32	10.81	9.65	5.84	1					
-----	-----	87898-0922	87898-0932	-----	87898-0952	9	-----	2	22.86	20.32	10.81	9.65	5.84	1					
-----	-----	87898-0924	87898-0934	-----	87898-0954	9	-----	4	22.86	20.32	10.81	9.65	5.84	1					
-----	-----	87898-0925	87898-0935	-----	87898-0955	9	-----	5	22.86	20.32	10.81	9.65	5.84	1					
-----	-----	87898-0926	87898-0936	-----	87898-0956	9	-----	6	22.86	20.32	10.81	9.65	5.84	1					

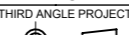
THIS DRAWING CONTAINS INFORMATION THAT IS PROPRIETARY TO MOLEX ELECTRONIC TECHNOLOGIES, LLC AND SHOULD NOT BE USED WITHOUT WRITTEN PERMISSION																					
DIMENSION UNITS		SCALE		CURRENT REV DESC:																	
mm		NTS		<div style="text-align: center;">  <p>CUSTOM HEADER 2.54MM PITCH SINGLE ROW SINGLE WAFER SMT HEADER</p> <p>PRODUCT CUSTOMER DRAWING</p> </div>																	
GENERAL TOLERANCES (UNLESS SPECIFIED)																					
		MM																		INCH	
4 PLACES	±		±																		
3 PLACES	±		±																		
2 PLACES	±	0.2	±																		
1 PLACE	±		±																		
0 PLACES	±		±																		
ANGULAR TOL ± 3.0°				EC NO: 745488 DRWN: SUAIFR 2023/02/15 CHK'D: SUAIFR 2023/04/10 APPR: MRAMAKRISHNA 2023/04/10 INITIAL REVISION: DRWN: GGUNAGI 2016/11/09 APPR: ISHWARG 2016/12/06																	
DRAFT WHERE APPLICABLE MUST REMAIN WITHIN DIMENSIONS				THIRD ANGLE PROJECTION		DRAWING		SERIES		MATERIAL NUMBER		CUSTOMER		DOCUMENT NUMBER		DOC TYPE		DOC PART		REVISION	
						A3-SIZE		87898		SEE TABLE		GENERAL MARKET		SD-87898-001		PSD		000		B26	
DOCUMENT STATUS				P1		RELEASE DATE		2023/04/10		07:46:21											

PACKAGING OPTION PART NO.										DIMENSION					CAP (SEE SHEET-16)
TRAY WITHOUT CAP	TRAY WITH CAP	TUBE WITHOUT CAP	TUBE WITH CAP	TAPE & REEL WITHOUT CAP	TAPE & REEL WITH CAP	CKT SIZE	VOID POSITION	PLATING TYPE	A	B	G	F	M		
-----	-----	87898-1021	87898-1031	-----	87898-1051	10	-----	1	25.40	22.86	10.81	9.65	5.84	1	
-----	-----	87898-1022	87898-1032	-----	87898-1052	10	-----	2	25.40	22.86	10.81	9.65	5.84	1	
-----	-----	87898-1024	87898-1034	-----	87898-1054	10	-----	4	25.40	22.86	10.81	9.65	5.84	1	
-----	-----	87898-1025	87898-1035	-----	87898-1055	10	-----	5	25.40	22.86	10.81	9.65	5.84	1	
-----	-----	87898-1026	87898-1036	-----	87898-1056	10	-----	6	25.40	22.86	10.81	9.65	5.84	1	
-----	-----	87898-1027	87898-1037	-----	87898-1057	10	-----	6	25.40	22.86	10.81	9.65	5.84	1	
-----	-----	87898-1003	-----	-----	-----	10	-----	5	25.40	22.86	---	9.81	6.00	1	
-----	-----	87898-1121	87898-1131	-----	87898-1151	11	-----	1	27.94	25.40	10.81	9.65	5.84	1	
-----	-----	87898-1122	87898-1132	-----	87898-1152	11	-----	2	27.94	25.40	10.81	9.65	5.84	1	
-----	-----	87898-1124	87898-1134	-----	87898-1154	11	-----	4	27.94	25.40	10.81	9.65	5.84	1	
-----	-----	87898-1125	87898-1135	-----	87898-1155	11	-----	5	27.94	25.40	10.81	9.65	5.84	1	
-----	-----	87898-1126	87898-1136	-----	87898-1156	11	-----	6	27.94	25.40	10.81	9.65	5.84	1	
-----	-----	87898-1221	87898-1231	-----	87898-1251	12	-----	1	30.48	27.94	10.81	9.65	5.84	1	
-----	-----	87898-1222	87898-1232	-----	87898-1252	12	-----	2	30.48	27.94	10.81	9.65	5.84	1	
-----	-----	87898-1224	87898-1234	-----	87898-1254	12	-----	4	30.48	27.94	10.81	9.65	5.84	1	
-----	-----	87898-1225	87898-1235	-----	87898-1255	12	-----	5	30.48	27.94	10.81	9.65	5.84	1	
-----	-----	87898-1226	87898-1236	-----	87898-1256	12	-----	6	30.48	27.94	10.81	9.65	5.84	1	

THIS DRAWING CONTAINS INFORMATION THAT IS PROPRIETARY TO MOLEX ELECTRONIC TECHNOLOGIES, LLC AND SHOULD NOT BE USED WITHOUT WRITTEN PERMISSION

DIMENSION UNITS	SCALE	CURRENT REV DESC:	molex
mm	NTS		
GENERAL TOLERANCES (UNLESS SPECIFIED)		EC NO: 745488 DRWN: SUAIFR CHK'D: SUAIFR APPR: MRAMAKRISHNA INITIAL REVISION: DRWN: GGUNAGI APPR: ISHWARG	CUSTOM HEADER 2.54MM PITCH SINGLE ROW SINGLE WAFER SMT HEADER PRODUCT CUSTOMER DRAWING
	MM INCH		
4 PLACES	± ±		
3 PLACES	± ±		
2 PLACES	± 0.2 ±		
1 PLACE	± ±		
0 PLACES	± ±	DOCUMENT NUMBER SD-87898-001	DOC TYPE PSD
ANGULAR TOL	± 3.0°	2023/02/15 2023/04/10 2023/04/10 2016/11/09 2016/12/06	DOC PART 000
DRAFT WHERE APPLICABLE MUST REMAIN WITHIN DIMENSIONS	THIRD ANGLE PROJECTION	DRAWING	SHEET NUMBER
		A3-SIZE	87898
		SERIES	5 OF 21
		MATERIAL NUMBER	SEE TABLE
		CUSTOMER	GENERAL MARKET

DOCUMENT STATUS	P1	RELEASE DATE	2023/04/10	07:46:21
-----------------	----	--------------	------------	----------

10		9		8		7		6		5		4		3		2		1	
PACKAGING OPTION PART NO.						CKT SIZE	VOID POSITION	PLATING TYPE	DIMENSION					CAP (SEE SHEET-16)					
TRAY WITHOUT CAP	TRAY WITH CAP	TUBE WITHOUT CAP	TUBE WITH CAP	TAPE & REEL WITHOUT CAP	TAPE & REEL WITH CAP				A	B	G	F	M						
-----	-----	87898-1321	87898-1331	-----	87898-1351	13	-----	1	33.02	30.48	10.81	9.65	5.84	1					
-----	-----	87898-1322	87898-1332	-----	87898-1352	13	-----	2	33.02	30.48	10.81	9.65	5.84	1					
-----	-----	87898-1324	87898-1334	-----	87898-1354	13	-----	4	33.02	30.48	10.81	9.65	5.84	1					
-----	-----	87898-1325	87898-1335	-----	87898-1355	13	-----	5	33.02	30.48	10.81	9.65	5.84	1					
-----	-----	87898-1326	87898-1336	-----	87898-1356	13	-----	6	33.02	30.48	10.81	9.65	5.84	1					
-----	-----	87898-1421	87898-1431	-----	87898-1451	14	-----	1	35.56	33.02	10.81	9.65	5.84	1					
-----	-----	87898-1422	87898-1432	-----	87898-1452	14	-----	2	35.56	33.02	10.81	9.65	5.84	1					
-----	-----	87898-1424	87898-1434	-----	87898-1454	14	-----	4	35.56	33.02	10.81	9.65	5.84	1					
-----	-----	87898-1425	87898-1435	-----	87898-1455	14	-----	5	35.56	33.02	10.81	9.65	5.84	1					
-----	-----	87898-1426	87898-1436	-----	87898-1456	14	-----	6	35.56	33.02	10.81	9.65	5.84	1					
-----	-----	87898-1427	87898-1437	-----	87898-1457	14	-----	6	35.56	33.02	10.81	9.65	5.84	1					
-----	-----	87898-1521	87898-1531	-----	87898-1551	15	-----	1	38.10	35.56	10.81	9.65	5.84	1					
-----	-----	87898-1522	87898-1532	-----	87898-1552	15	-----	2	38.10	35.56	10.81	9.65	5.84	1					
-----	-----	87898-1524	87898-1534	-----	87898-1554	15	-----	4	38.10	35.56	10.81	9.65	5.84	1					
-----	-----	87898-1525	87898-1535	-----	87898-1555	15	-----	5	38.10	35.56	10.81	9.65	5.84	1					
-----	-----	87898-1526	87898-1536	-----	87898-1556	15	-----	6	38.10	35.56	10.81	9.65	5.84	1					

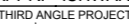
THIS DRAWING CONTAINS INFORMATION THAT IS PROPRIETARY TO MOLEX ELECTRONIC TECHNOLOGIES, LLC AND SHOULD NOT BE USED WITHOUT WRITTEN PERMISSION																	
DIMENSION UNITS		SCALE		CURRENT REV DESC:													
mm		NTS		<p style="text-align: center;">molex</p> <p style="text-align: center;">CUSTOM HEADER 2.54MM PITCH SINGLE ROW SINGLE WAFER SMT HEADER</p> <p style="text-align: center;">PRODUCT CUSTOMER DRAWING</p>													
GENERAL TOLERANCES (UNLESS SPECIFIED)																	
		MM	INCH														
4 PLACES	±		±														
3 PLACES	±		±														
2 PLACES	±	0.2	±														
1 PLACE	±		±														
0 PLACES	±		±														
ANGULAR TOL ± 3.0°				EC NO: 745488		DRWN: SUAIFR		2023/02/15		CHK'D: SUAIFR		2023/04/10		APPR: MRAMAKRISHNA		2023/04/10	
DRAFT WHERE APPLICABLE MUST REMAIN WITHIN DIMENSIONS				THIRD ANGLE PROJECTION		DRAWING		SERIES		MATERIAL NUMBER		CUSTOMER		SHEET NUMBER			
						A3-SIZE		87898		SEE TABLE		GENERAL MARKET		6 OF 21			

DOCUMENT STATUS	P1	RELEASE DATE	2023/04/10	07:46:21
-----------------	----	--------------	------------	----------

PACKAGING OPTION PART NO.										DIMENSION					CAP (SEE SHEET-16)
TRAY WITHOUT CAP	TRAY WITH CAP	TUBE WITHOUT CAP	TUBE WITH CAP	TAPE & REEL WITHOUT CAP	TAPE & REEL WITH CAP	CKT SIZE	VOID POSITION	PLATING TYPE	A	B	G	F	M		
-----	-----	87898-1621	87898-1631	-----	87898-1651	16	-----	1	40.64	38.10	10.81	9.65	5.84	1	
-----	-----	87898-1622	87898-1632	-----	87898-1652	16	-----	2	40.64	38.10	10.81	9.65	5.84	1	
-----	-----	87898-1624	87898-1634	-----	87898-1654	16	-----	4	40.64	38.10	10.81	9.65	5.84	1	
-----	-----	87898-1625	87898-1635	-----	87898-1655	16	-----	5	40.64	38.10	10.81	9.65	5.84	1	
-----	-----	87898-1626	87898-1636	-----	87898-1656	16	-----	6	40.64	38.10	10.81	9.65	5.84	1	
-----	-----	87898-1627	87898-1637	-----	87898-1657	16	-----	6	40.64	38.10	10.81	9.65	5.84	1	
-----	-----	87898-1721	87898-1731	-----	87898-1751	17	-----	1	43.18	40.64	10.81	9.65	5.84	1	
-----	-----	87898-1722	87898-1732	-----	87898-1752	17	-----	2	43.18	40.64	10.81	9.65	5.84	1	
-----	-----	87898-1724	87898-1734	-----	87898-1754	17	-----	4	43.18	40.64	10.81	9.65	5.84	1	
-----	-----	87898-1725	87898-1735	-----	87898-1755	17	-----	5	43.18	40.64	10.81	9.65	5.84	1	
-----	-----	87898-1726	87898-1736	-----	87898-1756	17	-----	6	43.18	40.64	10.81	9.65	5.84	1	
-----	-----	87898-1821	87898-1831	-----	87898-1851	18	-----	1	45.72	43.18	10.81	9.65	5.84	1	
-----	-----	87898-1822	87898-1832	-----	87898-1852	18	-----	2	45.72	43.18	10.81	9.65	5.84	1	
-----	-----	87898-1824	87898-1834	-----	87898-1854	18	-----	4	45.72	43.18	10.81	9.65	5.84	1	
-----	-----	87898-1825	87898-1835	-----	87898-1855	18	-----	5	45.72	43.18	10.81	9.65	5.84	1	
-----	-----	87898-1826	87898-1836	-----	87898-1856	18	-----	6	45.72	43.18	10.81	9.65	5.84	1	
-----	-----	87898-1827	87898-1837	-----	87898-1857	18	-----	6	45.72	43.18	10.81	9.65	5.84	1	

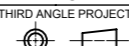
THIS DRAWING CONTAINS INFORMATION THAT IS PROPRIETARY TO MOLEX ELECTRONIC TECHNOLOGIES, LLC AND SHOULD NOT BE USED WITHOUT WRITTEN PERMISSION									
DIMENSION UNITS		SCALE		CURRENT REV DESC:					
mm		NTS		 CUSTOMER HEADER 2.54MM PITCH SINGLE ROW SINGLE WAFER SMT HEADER PRODUCT CUSTOMER DRAWING					
GENERAL TOLERANCES (UNLESS SPECIFIED)									
		MM	INCH						
4 PLACES	±		±						
3 PLACES	±		±						
2 PLACES	±	0.2	±						
1 PLACE	±		±						
0 PLACES	±		±						
ANGULAR TOL		± 3.0°		EC NO: 745488		DRWN: SUIAIFR		2023/02/15	
				CHK'D: SUIAIFR		APPR: MRAMAKRISHNA		2023/04/10	
				INITIAL REVISION:		DRWN: GGUNAGI		2016/11/09	
				APPR: ISHWARG		APPR: ISHWARG		2016/12/06	
DRAFT WHERE APPLICABLE MUST REMAIN WITHIN DIMENSIONS		THIRD ANGLE PROJECTION		DRAWING		SERIES		MATERIAL NUMBER	
				A3-SIZE		87898		SEE TABLE	
				CUSTOMER		GENERAL MARKET		SHEET NUMBER	
								7 OF 21	

DOCUMENT STATUS	P1	RELEASE DATE	2023/04/10	07:46:21
-----------------	----	--------------	------------	----------

10		9		8		7		6		5		4		3		2		1	
PACKAGING OPTION PART NO.						CKT SIZE	VOID POSITION	PLATING TYPE	DIMENSION					CAP (SEE SHEET-16)					
TRAY WITHOUT CAP	TRAY WITH CAP	TUBE WITHOUT CAP	TUBE WITH CAP	TAPE & REEL WITHOUT CAP	TAPE & REEL WITH CAP				A	B	G	F	M						
-----	-----	87898-1921	87898-1931	-----	87898-1951	19	-----	1	48.26	45.72	10.81	9.65	5.84	1					
-----	-----	87898-1922	87898-1932	-----	87898-1952	19	-----	2	48.26	45.72	10.81	9.65	5.84	1					
-----	-----	87898-1924	87898-1934	-----	87898-1954	19	-----	4	48.26	45.72	10.81	9.65	5.84	1					
-----	-----	87898-1925	87898-1935	-----	87898-1955	19	-----	5	48.26	45.72	10.81	9.65	5.84	1					
-----	-----	87898-1926	87898-1936	-----	87898-1956	19	-----	6	48.26	45.72	10.81	9.65	5.84	1					
-----	-----	87898-2021	87898-2031	-----	87898-2051	20	-----	1	50.80	48.26	10.81	9.65	5.84	1					
-----	-----	87898-2022	87898-2032	-----	87898-2052	20	-----	2	50.80	48.26	10.81	9.65	5.84	1					
-----	-----	87898-2024	87898-2034	-----	87898-2054	20	-----	4	50.80	48.26	10.81	9.65	5.84	1					
-----	-----	87898-2025	87898-2035	-----	87898-2055	20	-----	5	50.80	48.26	10.81	9.65	5.84	1					
-----	-----	87898-2026	87898-2036	-----	87898-2056	20	-----	6	50.80	48.26	10.81	9.65	5.84	1					
-----	-----	87898-2027	87898-2037	-----	87898-2057	20	-----	6	50.80	48.26	10.81	9.65	5.84	1					
-----	-----	87898-2121	87898-2131	-----	87898-2151	21	-----	1	53.34	50.80	10.81	9.65	5.84	1					
-----	-----	87898-2122	87898-2132	-----	87898-2152	21	-----	2	53.34	50.80	10.81	9.65	5.84	1					
-----	-----	87898-2124	87898-2134	-----	87898-2154	21	-----	4	53.34	50.80	10.81	9.65	5.84	1					
-----	-----	87898-2125	87898-2135	-----	87898-2155	21	-----	5	53.34	50.80	10.81	9.65	5.84	1					
-----	-----	87898-2126	87898-2136	-----	87898-2156	21	-----	6	53.34	50.80	10.81	9.65	5.84	1					

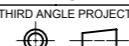
THIS DRAWING CONTAINS INFORMATION THAT IS PROPRIETARY TO MOLEX ELECTRONIC TECHNOLOGIES, LLC AND SHOULD NOT BE USED WITHOUT WRITTEN PERMISSION																	
DIMENSION UNITS		SCALE		CURRENT REV DESC:													
mm		NTS															
GENERAL TOLERANCES (UNLESS SPECIFIED)				EC NO: 745488 DRWN: SUAIFR CHK'D: SUAIFR APPR: MRAMAKRISHNA INITIAL REVISION: DRWN: GGUNAGI APPR: ISHWARG						2023/02/15 2023/04/10 2023/04/10 2016/11/09 2016/12/06							
ANGULAR TOL ± 3.0°				DRAWING		SERIES		MATERIAL NUMBER		CUSTOMER		SHEET NUMBER					
DRAFT WHERE APPLICABLE MUST REMAIN WITHIN DIMENSIONS				A3-SIZE		87898		SEE TABLE		GENERAL MARKET		8 OF 21					
				CUSTOMER DRAWING 2.54MM PITCH SINGLE ROW SINGLE WAFER SMT HEADER				DOCUMENT NUMBER SD-87898-001				DOC TYPE PSD		DOC PART 000		REVISION B26	

DOCUMENT STATUS	P1	RELEASE DATE	2023/04/10	07:46:21
-----------------	----	--------------	------------	----------

PACKAGING OPTION PART NO.										DIMENSION					CAP (SEE SHEET-16)
TRAY WITHOUT CAP	TRAY WITH CAP	TUBE WITHOUT CAP	TUBE WITH CAP	TAPE & REEL WITHOUT CAP	TAPE & REEL WITH CAP	CKT SIZE	VOID POSITION	PLATING TYPE	A	B	G	F	M		
-----	-----	87898-2221	87898-2231	-----	-----	22	----	1	55.88	53.34	10.81	9.65	5.84	1	
-----	-----	87898-2222	87898-2232	-----	-----	22	----	2	55.88	53.34	10.81	9.65	5.84	1	
-----	-----	87898-2224	87898-2234	-----	-----	22	----	4	55.88	53.34	10.81	9.65	5.84	1	
-----	-----	87898-2225	87898-2235	-----	-----	22	----	5	55.88	53.34	10.81	9.65	5.84	1	
-----	-----	87898-2226	87898-2236	-----	-----	22	----	6	55.88	53.34	10.81	9.65	5.84	1	
-----	-----	87898-2321	87898-2331	-----	-----	23	----	1	58.42	55.88	10.81	9.65	5.84	1	
-----	-----	87898-2322	87898-2332	-----	-----	23	----	2	58.42	55.88	10.81	9.65	5.84	1	
-----	-----	87898-2324	87898-2334	-----	-----	23	----	4	58.42	55.88	10.81	9.65	5.84	1	
-----	-----	87898-2325	87898-2335	-----	-----	23	----	5	58.42	55.88	10.81	9.65	5.84	1	
-----	-----	87898-2326	87898-2336	-----	-----	23	----	6	58.42	55.88	10.81	9.65	5.84	1	
-----	-----	87898-2421	87898-2431	-----	-----	24	----	1	60.96	58.42	10.81	9.65	5.84	1	
-----	-----	87898-2422	87898-2432	-----	-----	24	----	2	60.96	58.42	10.81	9.65	5.84	1	
-----	-----	87898-2424	87898-2434	-----	-----	24	----	4	60.96	58.42	10.81	9.65	5.84	1	
-----	-----	87898-2425	87898-2435	-----	-----	24	----	5	60.96	58.42	10.81	9.65	5.84	1	
-----	-----	87898-2426	87898-2436	-----	-----	24	----	6	60.96	58.42	10.81	9.65	5.84	1	
-----	-----	87898-2427	87898-2437	-----	-----	24	----	6	60.96	58.42	10.81	9.65	5.84	1	

D										E					F				
C										B					A				
B										A					A				
A										A					A				

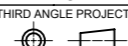
THIS DRAWING CONTAINS INFORMATION THAT IS PROPRIETARY TO MOLEX ELECTRONIC TECHNOLOGIES, LLC AND SHOULD NOT BE USED WITHOUT WRITTEN PERMISSION																		
DIMENSION UNITS		SCALE		CURRENT REV DESC:					 CUSTOM HEADER 2.54MM PITCH SINGLE ROW SINGLE WAFER SMT HEADER									
mm		NTS																
GENERAL TOLERANCES (UNLESS SPECIFIED)										EC NO: 745488								
										DRWN: SUAIFR 2023/02/15								
										CHK'D: SUAIFR 2023/04/10								
										APPR: MRAMAKRISHNA 2023/04/10								
										INITIAL REVISION:								
										DRWN: GGUNAGI 2016/11/09								
										APPR: ISHWARG 2016/12/06								
ANGULAR TOL ± 3.0°										DOCUMENT NUMBER		DOC TYPE		DOC PART	REVISION			
DRAFT WHERE APPLICABLE MUST REMAIN WITHIN DIMENSIONS										SD-87898-001		PSD		000	B26			
THIRD ANGLE PROJECTION										DRAWING		SERIES		MATERIAL NUMBER		CUSTOMER		SHEET NUMBER
										A3-SIZE		87898		SEE TABLE		GENERAL MARKET		9 OF 21

DOCUMENT STATUS	P1	RELEASE DATE	2023/04/10	07:46:21
-----------------	----	--------------	------------	----------

10		9		8		7		6		5		4		3		2		1	
PACKAGING OPTION PART NO.														CAP (SEE SHEET-16)					
TRAY WITHOUT CAP	TRAY WITH CAP	TUBE WITHOUT CAP	TUBE WITH CAP	TAPE & REEL WITHOUT CAP	TAPE & REEL WITH CAP	CKT SIZE	VOID POSITION	PLATING TYPE	DIMENSION										
									A	B	G	F	M						
-----	-----	87898-2521	87898-2531	-----	-----	25	-----	1	63.50	60.96	10.81	9.65	5.84	1					
-----	-----	87898-2522	87898-2532	-----	-----	25	-----	2	63.50	60.96	10.81	9.65	5.84	1					
-----	-----	87898-2524	87898-2534	-----	-----	25	-----	4	63.50	60.96	10.81	9.65	5.84	1					
-----	-----	87898-2525	87898-2535	-----	-----	25	-----	5	63.50	60.96	10.81	9.65	5.84	1					
-----	-----	87898-2526	87898-2536	-----	-----	25	-----	6	63.50	60.96	10.81	9.65	5.84	1					
-----	-----	87898-2621	87898-2631	-----	-----	26	-----	1	66.04	63.50	10.81	9.65	5.84	1					
-----	-----	87898-2622	87898-2632	-----	-----	26	-----	2	66.04	63.50	10.81	9.65	5.84	1					
-----	-----	87898-2624	87898-2634	-----	-----	26	-----	4	66.04	63.50	10.81	9.65	5.84	1					
-----	-----	87898-2625	87898-2635	-----	-----	26	-----	5	66.04	63.50	10.81	9.65	5.84	1					
-----	-----	87898-2626	87898-2636	-----	-----	26	-----	6	66.04	63.50	10.81	9.65	5.84	1					
-----	-----	87898-2627	87898-2637	-----	-----	26	-----	6	66.04	63.50	10.81	9.65	5.84	1					
-----	-----	87898-2721	87898-2731	-----	-----	27	-----	1	68.58	66.04	10.81	9.65	5.84	1					
-----	-----	87898-2722	87898-2732	-----	-----	27	-----	2	68.58	66.04	10.81	9.65	5.84	1					
-----	-----	87898-2724	87898-2734	-----	-----	27	-----	4	68.58	66.04	10.81	9.65	5.84	1					
-----	-----	87898-2725	87898-2735	-----	-----	27	-----	5	68.58	66.04	10.81	9.65	5.84	1					
-----	-----	87898-2726	87898-2736	-----	-----	27	-----	6	68.58	66.04	10.81	9.65	5.84	1					

THIS DRAWING CONTAINS INFORMATION THAT IS PROPRIETARY TO MOLEX ELECTRONIC TECHNOLOGIES, LLC AND SHOULD NOT BE USED WITHOUT WRITTEN PERMISSION															
DIMENSION UNITS		SCALE		CURRENT REV DESC:											
mm		NTS		<p style="text-align: center;">molex</p> <p style="text-align: center;">CUSTOM HEADER 2.54MM PITCH SINGLE ROW SINGLE WAFER SMT HEADER</p> <p style="text-align: center;">PRODUCT CUSTOMER DRAWING</p>											
GENERAL TOLERANCES (UNLESS SPECIFIED)															
		MM												INCH	
4 PLACES	±		±												
3 PLACES	±		±												
2 PLACES	±	0.2	±												
1 PLACE	±		±												
0 PLACES	±		±												
ANGULAR TOL ± 3.0°				EC NO: 745488 DRWN: SUAIFR CHK'D: SUAIFR APPR: MRAMAKRISHNA INITIAL REVISION: DRWN: GGUNAGI APPR: ISHWARG											
DRAFT WHERE APPLICABLE MUST REMAIN WITHIN DIMENSIONS		THIRD ANGLE PROJECTION		DRAWING		SERIES		MATERIAL NUMBER		CUSTOMER		SHEET NUMBER			
				A3-SIZE		87898		SEE TABLE		GENERAL MARKET		10 OF 21			

DOCUMENT STATUS	P1	RELEASE DATE	2023/04/10	07:46:21
-----------------	----	--------------	------------	----------

FORMAT: Mel-lega-master-ib-prod-A3
 REVISION: E
 DATE: 2023/01/14

PACKAGING OPTION PART NO.						CKT SIZE	VOID POSITION	PLATING TYPE	DIMENSION					CAP (SEE SHEET-16)
TRAY WITHOUT CAP	TRAY WITH CAP	TUBE WITHOUT CAP	TUBE WITH CAP	TAPE & REEL WITHOUT CAP	TAPE & REEL WITH CAP				A	B	G	F	M	
-----	-----	87898-2821	87898-2831	-----	-----	28	----	1	71.12	68.58	10.81	9.65	5.84	1
-----	-----	87898-2822	87898-2832	-----	-----	28	----	2	71.12	68.58	10.81	9.65	5.84	1
-----	-----	87898-2824	87898-2834	-----	-----	28	----	4	71.12	68.58	10.81	9.65	5.84	1
-----	-----	87898-2825	87898-2835	-----	-----	28	----	5	71.12	68.58	10.81	9.65	5.84	1
-----	-----	87898-2826	87898-2836	-----	-----	28	----	6	71.12	68.58	10.81	9.65	5.84	1
-----	-----	87898-2921	87898-2931	-----	-----	29	----	1	73.66	71.12	10.81	9.65	5.84	1
-----	-----	87898-2922	87898-2932	-----	-----	29	----	2	73.66	71.12	10.81	9.65	5.84	1
-----	-----	87898-2924	87898-2934	-----	-----	29	----	4	73.66	71.12	10.81	9.65	5.84	1
-----	-----	87898-2925	87898-2935	-----	-----	29	----	5	73.66	71.12	10.81	9.65	5.84	1
-----	-----	87898-2926	87898-2936	-----	-----	29	----	6	73.66	71.12	10.81	9.65	5.84	1
-----	-----	87898-3021	87898-3031	-----	-----	30	----	1	76.20	73.66	10.81	9.65	5.84	1
-----	-----	87898-3022	87898-3032	-----	-----	30	----	2	76.20	73.66	10.81	9.65	5.84	1
-----	-----	87898-3024	87898-3034	-----	-----	30	----	4	76.20	73.66	10.81	9.65	5.84	1
-----	-----	87898-3025	87898-3035	-----	-----	30	----	5	76.20	73.66	10.81	9.65	5.84	1
-----	-----	87898-3026	87898-3036	-----	-----	30	----	6	76.20	73.66	10.81	9.65	5.84	1



THIS DRAWING CONTAINS INFORMATION THAT IS PROPRIETARY TO MOLEX ELECTRONIC TECHNOLOGIES, LLC AND SHOULD NOT BE USED WITHOUT WRITTEN PERMISSION															
DIMENSION UNITS		SCALE		CURRENT REV DESC:											
mm		NTS													
GENERAL TOLERANCES (UNLESS SPECIFIED)				EC NO: 745488 DRWN: SUAIFR CHK'D: SUAIFR APPR: MRAMAKRISHNA INITIAL REVISION: DRWN: GGUNAGI APPR: ISHWARG						CUSTOM HEADER 2.54MM PITCH SINGLE ROW SINGLE WAFER SMT HEADER PRODUCT CUSTOMER DRAWING					
		MM												INCH	
4 PLACES	±		±												
3 PLACES	±		±												
2 PLACES	±	0.2	±												
1 PLACE	±		±												
0 PLACES	±		±												
ANGULAR TOL		± 3.0°		2023/02/15 2023/04/10 2023/04/10 2016/11/09 2016/12/06						DOCUMENT NUMBER SD-87898-001 DOC TYPE PSD DOC PART 000 REVISION B26					
DRAFT WHERE APPLICABLE MUST REMAIN WITHIN DIMENSIONS				THIRD ANGLE PROJECTION		DRAWING		SERIES		MATERIAL NUMBER		CUSTOMER		SHEET NUMBER	
						A3-SIZE		87898		SEE TABLE		GENERAL MARKET		11 OF 21	

DOCUMENT STATUS	P1	RELEASE DATE	2023/04/10	07:46:21
-----------------	----	--------------	------------	----------

10		9		8		7		6		5		4		3		2		1	
PACKAGING OPTION PART NO.														CAP (SEE SHEET-16)					
TRAY WITHOUT CAP	TRAY WITH CAP	TUBE WITHOUT CAP	TUBE WITH CAP	TAPE & REEL WITHOUT CAP	TAPE & REEL WITH CAP	CKT SIZE	VOID POSITION	PLATING TYPE	DIMENSION										
									A	B	G	F	M						
-----	-----	87898-3121	87898-3131	-----	-----	31	-----	1	78.74	76.20	10.81	9.65	5.84	1					
-----	-----	87898-3122	87898-3132	-----	-----	31	-----	2	78.74	76.20	10.81	9.65	5.84	1					
-----	-----	87898-3124	87898-3134	-----	-----	31	-----	4	78.74	76.20	10.81	9.65	5.84	1					
-----	-----	87898-3125	87898-3135	-----	-----	31	-----	5	78.74	76.20	10.81	9.65	5.84	1					
-----	-----	87898-3126	87898-3136	-----	-----	31	-----	6	78.74	76.20	10.81	9.65	5.84	1					
-----	-----	87898-3221	87898-3231	-----	-----	32	-----	1	81.28	78.74	10.81	9.65	5.84	1					
-----	-----	87898-3222	87898-3232	-----	-----	32	-----	2	81.28	78.74	10.81	9.65	5.84	1					
-----	-----	87898-3224	87898-3234	-----	-----	32	-----	4	81.28	78.74	10.81	9.65	5.84	1					
-----	-----	87898-3225	87898-3235	-----	-----	32	-----	5	81.28	78.74	10.81	9.65	5.84	1					
-----	-----	87898-3226	87898-3236	-----	-----	32	-----	6	81.28	78.74	10.81	9.65	5.84	1					
-----	-----	87898-3227	87898-3237	-----	-----	32	-----	6	81.28	78.74	10.81	9.65	5.84	1					
-----	-----	87898-3321	87898-3331	-----	-----	33	-----	1	83.82	81.28	10.81	9.65	5.84	1					
-----	-----	87898-3322	87898-3332	-----	-----	33	-----	2	83.82	81.28	10.81	9.65	5.84	1					
-----	-----	87898-3324	87898-3334	-----	-----	33	-----	4	83.82	81.28	10.81	9.65	5.84	1					
-----	-----	87898-3325	87898-3335	-----	-----	33	-----	5	83.82	81.28	10.81	9.65	5.84	1					
-----	-----	87898-3326	87898-3336	-----	-----	33	-----	6	83.82	81.28	10.81	9.65	5.84	1					

THIS DRAWING CONTAINS INFORMATION THAT IS PROPRIETARY TO MOLEX ELECTRONIC TECHNOLOGIES, LLC AND SHOULD NOT BE USED WITHOUT WRITTEN PERMISSION

DIMENSION UNITS	SCALE	CURRENT REV DESC:	
mm	NTS		
GENERAL TOLERANCES (UNLESS SPECIFIED)			
	MM	INCH	
4 PLACES	±	±	
3 PLACES	±	±	
2 PLACES	± 0.2	±	
1 PLACE	±	±	
0 PLACES	±	±	
ANGULAR TOL	± 3.0°		
DRAFT WHERE APPLICABLE MUST REMAIN WITHIN DIMENSIONS		THIRD ANGLE PROJECTION	DRAWING
			A3-SIZE
		SERIES	87898
		MATERIAL NUMBER	SEE TABLE
		CUSTOMER	GENERAL MARKET
		SHEET NUMBER	12 OF 21

EC NO: 745488
 DRWN: SUAIFR
 APPR: MRAMAKRISHNA

2023/02/15
 2023/04/10
 2023/04/10

molex

CUSTOM HEADER
 2.54MM PITCH SINGLE ROW SINGLE WAFER SMT
 HEADER

PRODUCT CUSTOMER DRAWING

DOCUMENT NUMBER
SD-87898-001

DOC TYPE
 PSD

DOC PART
 000

REVISION
 B26

DOCUMENT STATUS	P1	RELEASE DATE	2023/04/10	07:46:21
-----------------	----	--------------	------------	----------

PACKAGING OPTION PART NO.										DIMENSION					CAP (SEE SHEET-16)
TRAY WITHOUT CAP	TRAY WITH CAP	TUBE WITHOUT CAP	TUBE WITH CAP	TAPE & REEL WITHOUT CAP	TAPE & REEL WITH CAP	CKT SIZE	VOID POSITION	PLATING TYPE	A	B	G	F	M		
-----	-----	87898-3421	87898-3431	-----	-----	34	-----	1	86.36	83.82	10.81	9.65	5.84	1	
-----	-----	87898-3422	87898-3432	-----	-----	34	-----	2	86.36	83.82	10.81	9.65	5.84	1	
-----	-----	87898-3424	87898-3434	-----	-----	34	-----	4	86.36	83.82	10.81	9.65	5.84	1	
-----	-----	87898-3425	87898-3435	-----	-----	34	-----	5	86.36	83.82	10.81	9.65	5.84	1	
-----	-----	87898-3426	87898-3436	-----	-----	34	-----	6	86.36	83.82	10.81	9.65	5.84	1	
-----	-----	87898-3521	87898-3531	-----	-----	35	-----	1	88.90	86.36	10.81	9.65	5.84	1	
-----	-----	87898-3522	87898-3532	-----	-----	35	-----	2	88.90	86.36	10.81	9.65	5.84	1	
-----	-----	87898-3524	87898-3534	-----	-----	35	-----	4	88.90	86.36	10.81	9.65	5.84	1	
-----	-----	87898-3525	87898-3535	-----	-----	35	-----	5	88.90	86.36	10.81	9.65	5.84	1	
-----	-----	87898-3526	87898-3536	-----	-----	35	-----	6	88.90	86.36	10.81	9.65	5.84	1	
-----	-----	87898-3621	87898-3631	-----	-----	36	-----	1	91.44	88.90	10.81	9.65	5.84	1	
-----	-----	87898-3622	87898-3632	-----	-----	36	-----	2	91.44	88.90	10.81	9.65	5.84	1	
-----	-----	87898-3624	87898-3634	-----	-----	36	-----	4	91.44	88.90	10.81	9.65	5.84	1	
-----	-----	87898-3625	87898-3635	-----	-----	36	-----	5	91.44	88.90	10.81	9.65	5.84	1	
-----	-----	87898-3626	87898-3636	-----	-----	36	-----	6	91.44	88.90	10.81	9.65	5.84	1	

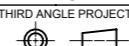
THIS DRAWING CONTAINS INFORMATION THAT IS PROPRIETARY TO MOLEX ELECTRONIC TECHNOLOGIES, LLC AND SHOULD NOT BE USED WITHOUT WRITTEN PERMISSION															
DIMENSION UNITS		SCALE		CURRENT REV DESC:											
mm		NTS													
GENERAL TOLERANCES (UNLESS SPECIFIED)				EC NO: 745488 DRWN: SUAIFR CHK'D: SUAIFR APPR: MRAMAKRISHNA INITIAL REVISION: DRWN: GGUNAGI APPR: ISHWARG				CUSTOM HEADER 2.54MM PITCH SINGLE ROW SINGLE WAFER SMT HEADER							
								PRODUCT CUSTOMER DRAWING							
								DOCUMENT NUMBER		DOC TYPE		DOC PART		REVISION	
				SD-87898-001		PSD		000		B26					
DRAFT WHERE APPLICABLE MUST REMAIN WITHIN DIMENSIONS				THIRD ANGLE PROJECTION		DRAWING		SERIES		MATERIAL NUMBER		CUSTOMER		SHEET NUMBER	
						A3-SIZE		87898		SEE TABLE		GENERAL MARKET		13 OF 21	

DOCUMENT STATUS	P1	RELEASE DATE	2023/04/10	07:46:21
-----------------	----	--------------	------------	----------

PACKAGING OPTION PART NO.						CKT SIZE	VOID POSITION	PLATING TYPE	DIMENSION					CAP (SEE SHEET-16)
TRAY WITHOUT CAP	TRAY WITH CAP	TUBE WITHOUT CAP	TUBE WITH CAP	TAPE & REEL WITHOUT CAP	TAPE & REEL WITH CAP				A	B	G	F	M	
-----	-----	87898-3721	87898-3731	-----	-----	37	----	1	93.98	91.44	10.81	9.65	5.84	1
-----	-----	87898-3722	87898-3732	-----	-----	37	----	2	93.98	91.44	10.81	9.65	5.84	1
-----	-----	87898-3724	87898-3734	-----	-----	37	----	4	93.98	91.44	10.81	9.65	5.84	1
-----	-----	87898-3725	87898-3735	-----	-----	37	----	5	93.98	91.44	10.81	9.65	5.84	1
-----	-----	87898-3726	87898-3736	-----	-----	37	----	6	93.98	91.44	10.81	9.65	5.84	1
-----	-----	87898-3821	87898-3831	-----	-----	38	----	1	96.52	93.98	10.81	9.65	5.84	1
-----	-----	87898-3822	87898-3832	-----	-----	38	----	2	96.52	93.98	10.81	9.65	5.84	1
-----	-----	87898-3824	87898-3834	-----	-----	38	----	4	96.52	93.98	10.81	9.65	5.84	1
-----	-----	87898-3825	87898-3835	-----	-----	38	----	5	96.52	93.98	10.81	9.65	5.84	1
-----	-----	87898-3826	87898-3836	-----	-----	38	----	6	96.52	93.98	10.81	9.65	5.84	1
-----	-----	87898-3921	87898-3931	-----	-----	39	----	1	99.06	96.52	10.81	9.65	5.84	1
-----	-----	87898-3922	87898-3932	-----	-----	39	----	2	99.06	96.52	10.81	9.65	5.84	1
-----	-----	87898-3924	87898-3934	-----	-----	39	----	4	99.06	96.52	10.81	9.65	5.84	1
-----	-----	87898-3925	87898-3935	-----	-----	39	----	5	99.06	96.52	10.81	9.65	5.84	1
-----	-----	87898-3926	87898-3936	-----	-----	39	----	6	99.06	96.52	10.81	9.65	5.84	1

THIS DRAWING CONTAINS INFORMATION THAT IS PROPRIETARY TO MOLEX ELECTRONIC TECHNOLOGIES, LLC AND SHOULD NOT BE USED WITHOUT WRITTEN PERMISSION

DIMENSION UNITS	SCALE	CURRENT REV DESC:	molex			
mm	NTS					
GENERAL TOLERANCES (UNLESS SPECIFIED)		EC NO: 745488 DRWN: SUAIFR CHK'D: SUAIFR APPR: MRAMAKRISHNA INITIAL REVISION: DRWN: GGUNAGI APPR: ISHWARG	CUSTOM HEADER 2.54MM PITCH SINGLE ROW SINGLE WAFER SMT HEADER PRODUCT CUSTOMER DRAWING			
	MM INCH					
4 PLACES	± ±					
3 PLACES	± ±					
2 PLACES	± 0.2 ±					
1 PLACE	± ±					
0 PLACES	± ±	2023/02/15 2023/04/10 2023/04/10	DOCUMENT NUMBER SD-87898-001	DOC TYPE PSD	DOC PART 000	REVISION B26
ANGULAR TOL	± 3.0°	2016/11/09 2016/12/06	MATERIAL NUMBER SEE TABLE	CUSTOMER GENERAL MARKET	SHEET NUMBER 14 OF 21	
DRAFT WHERE APPLICABLE MUST REMAIN WITHIN DIMENSIONS		THIRD ANGLE PROJECTION 	DRAWING A3-SIZE	SERIES 87898		

DOCUMENT STATUS	P1	RELEASE DATE	2023/04/10	07:46:21
-----------------	----	--------------	------------	----------

PACKAGING OPTION PART NO.						CKT SIZE	VOID POSITION	PLATING TYPE	DIMENSION					CAP (SEE SHEET-16)
TRAY WITHOUT CAP	TRAY WITH CAP	TUBE WITHOUT CAP	TUBE WITH CAP	TAPE & REEL WITHOUT CAP	TAPE & REEL WITH CAP				A	B	G	F	M	
-----	-----	87898-4021	87898-4031	-----	-----	40	-----	1	101.60	99.06	10.81	9.65	5.84	1
-----	-----	87898-4022	87898-4032	-----	-----	40	-----	2	101.60	99.06	10.81	9.65	5.84	1
-----	-----	87898-4024	87898-4034	-----	-----	40	-----	4	101.60	99.06	10.81	9.65	5.84	1
-----	-----	87898-4025	87898-4035	-----	-----	40	-----	5	101.60	99.06	10.81	9.65	5.84	1
-----	-----	87898-4026	87898-4036	-----	-----	40	-----	6	101.60	99.06	10.81	9.65	5.84	1



THIS DRAWING CONTAINS INFORMATION THAT IS PROPRIETARY TO MOLEX ELECTRONIC TECHNOLOGIES, LLC AND SHOULD NOT BE USED WITHOUT WRITTEN PERMISSION																					
DIMENSION UNITS		SCALE		CURRENT REV DESC:																	
mm		NTS																			
GENERAL TOLERANCES (UNLESS SPECIFIED)				EC NO: 745488 DRWN: SUAIFR 2023/02/15 CHK'D: SUAIFR 2023/04/10 APPR: MRAMAKRISHNA 2023/04/10 INITIAL REVISION: DRWN: GGUNAGI 2016/11/09 APPR: ISHWARG 2016/12/06						CUSTOM HEADER 2.54MM PITCH SINGLE ROW SINGLE WAFER SMT HEADER											
														PRODUCT CUSTOMER DRAWING							
										DOCUMENT NUMBER		DOC TYPE						DOC PART		REVISION	
4 PLACES ±		±								SD-87898-001		PSD						000		B26	
3 PLACES ±		±																			
2 PLACES ±		0.2 ±																			
1 PLACE ±		±																			
0 PLACES ±		±																			
ANGULAR TOL ± 3.0°				THIRD ANGLE PROJECTION		DRAWING		SERIES		MATERIAL NUMBER		CUSTOMER		SHEET NUMBER							
DRAFT WHERE APPLICABLE MUST REMAIN WITHIN DIMENSIONS						A3-SIZE		87898		SEE TABLE		GENERAL MARKET		15 OF 21							

DOCUMENT STATUS	P1	RELEASE DATE	2023/04/10	07:46:21
-----------------	----	--------------	------------	----------

CAP ORIENTATION (CAP - 1)

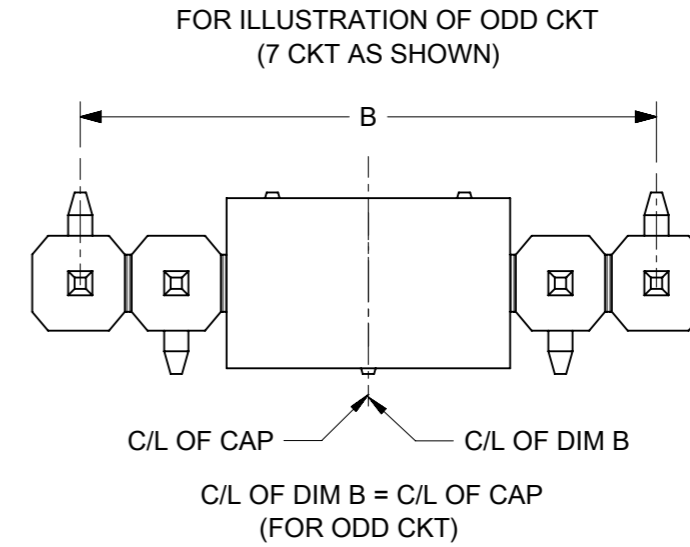

CAP ORIENTATION (CAP - 2)

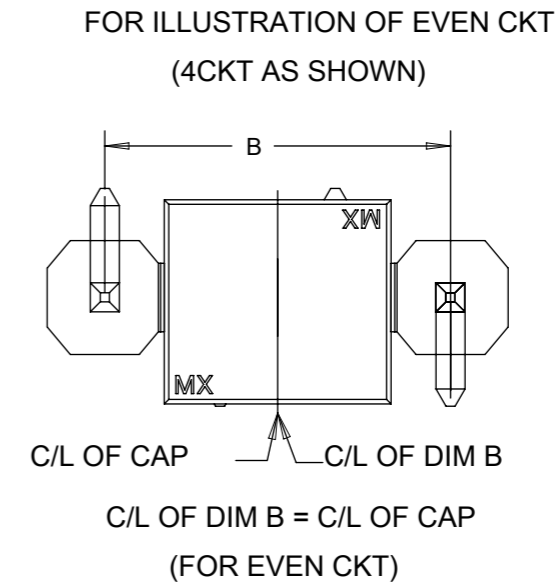
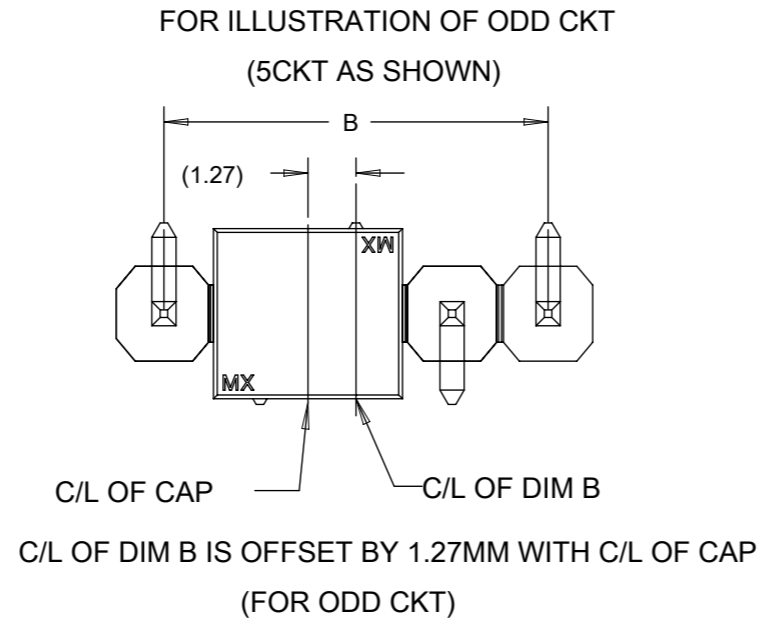

PART ORIENTATION IN TUBE



PART WITHOUT CAP

PART WITH CAP

THIS DRAWING CONTAINS INFORMATION THAT IS PROPRIETARY TO MOLEX ELECTRONIC TECHNOLOGIES, LLC AND SHOULD NOT BE USED WITHOUT WRITTEN PERMISSION											
DIMENSION UNITS		SCALE		CURRENT REV DESC:							
mm		NTS									
GENERAL TOLERANCES (UNLESS SPECIFIED)											
		MM		INCH							
4 PLACES		±		±		EC NO: 745488					
3 PLACES		±		±		DRWN: SUAIFR		2023/02/15			
2 PLACES		±		0.2		CHK'D: SUAIFR		2023/04/10			
1 PLACE		±		±		APPR: MRAMAKRISHNA		2023/04/10			
0 PLACES		±		±		INITIAL REVISION:					
ANGULAR TOL		±		3.0°		DRWN: GGUNAGI		2016/11/09		DOCUMENT NUMBER	
						APPR: ISHWARG		2016/12/06		SD-87898-001	
DRAFT WHERE APPLICABLE MUST REMAIN WITHIN DIMENSIONS				THIRD ANGLE PROJECTION		DRAWING		SERIES		MATERIAL NUMBER	
						A3-SIZE		87898		CUSTOMER	
										GENERAL MARKET	
										SEE TABLE	
										PSD 000 B26	
										REVISION	
										16 OF 21	

EMBOSED CARRIER TYPE 'A'

CKT	DIMENSION				
	Bo	Ao	Ko	F	W
2	8.02	5.20	13.60	11.50	24.00
3	8.02	5.20	13.60	11.50	24.00
4	10.55	5.20	13.60	11.50	24.00

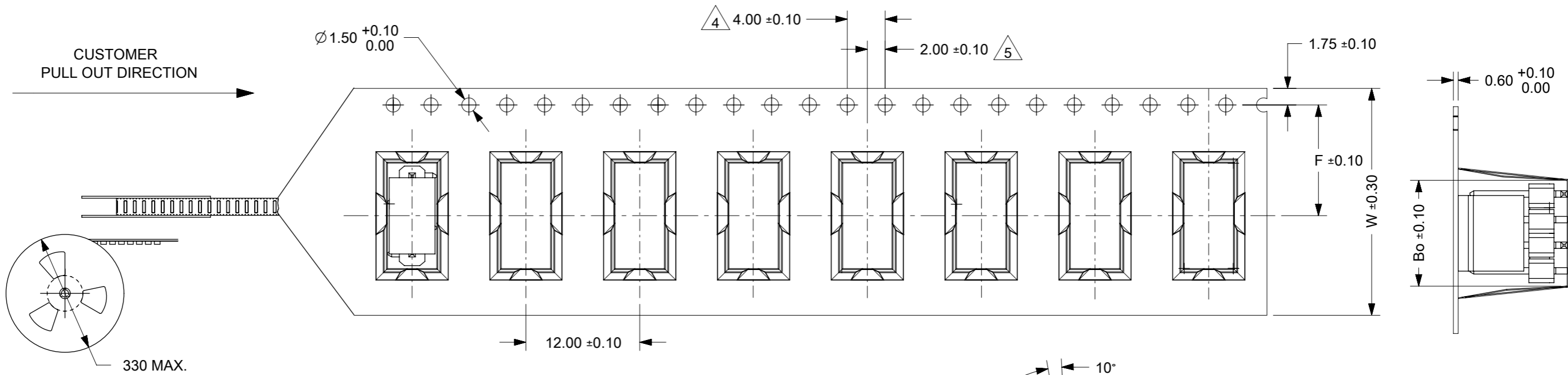

NOTES:
1. LEADER AND TRAILER TAPE

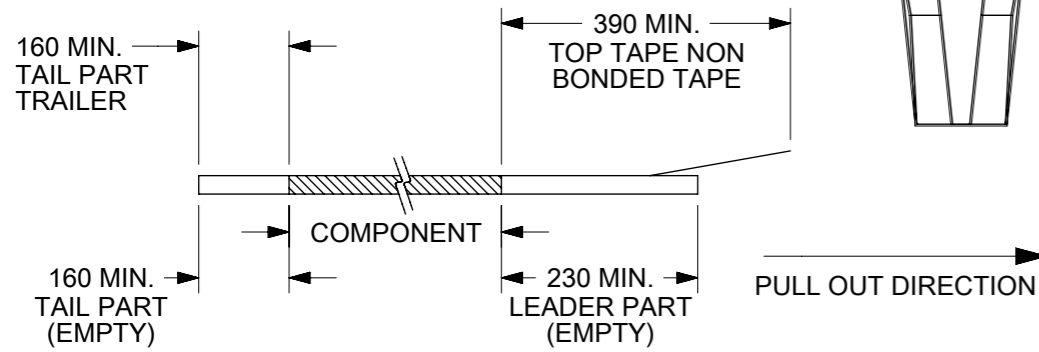

2. PEELING OFF FORCE OF THE TOP TAPE: 20 - 80gf.
(PEELING DIRECTION AS SHOWN IN FOLLOWING FIGURE)

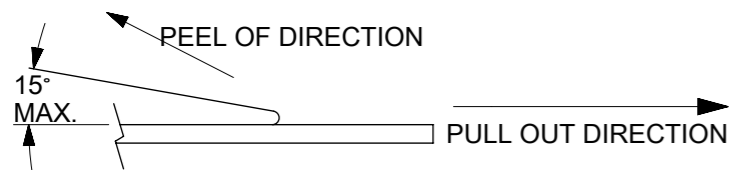

3. MATERIAL: BLACK P.S CONDUCTIVE, BLACK

4. MEASURED FROM CENTRELINE OF SPROCKET HOLE TO CENTRELINE OF SPOCKET

5. CUMULATIVE TOLERANCE OF 10 SPROCKET HOLE IS ± 0.20 mm

6. A0 AND B0 ARE MEASURE FROM ABOVE POCKET BASE 0.30mm

7. TAPE AND REEL SPECIFICATION IS AS PER EIA-481.

8. TAPE AND REEL QUANTITY : 440PCS/REEL

9. THE TAPE IS TREATED FOR ANTI-STATIC.

10. ALL RADIUS ARE 0.30MM UNLESS SPECIFY

11. SURFACE RESISTIVITY 10^3 TO 10^6 OHMS.

PART PACK
IN E/TAPE
ORIENTATION
(FOR REF USE)

THIS DRAWING CONTAINS INFORMATION THAT IS PROPRIETARY TO MOLEX ELECTRONIC TECHNOLOGIES, LLC AND SHOULD NOT BE USED WITHOUT WRITTEN PERMISSION		CURRENT REV DESC:			
DIMENSION UNITS	SCALE	EC NO: 745488			
mm	NTS	DRWN: SUAIFR 2023/02/15		CUSTOM HEADER 2.54MM PITCH SINGLE ROW SINGLE WAFER SMT HEADER	
GENERAL TOLERANCES (UNLESS SPECIFIED)		CHK'D: SUAIFR 2023/04/10			
		MM	INCH	PRODUCT CUSTOMER DRAWING	
4 PLACES	\pm	\pm		DOCUMENT NUMBER	
3 PLACES	\pm	\pm		SD-87898-001	
2 PLACES	± 0.2	\pm		DOC TYPE	DOC PART
1 PLACE	\pm	\pm		PSD	000
0 PLACES	\pm	\pm		REVISION	B26
ANGULAR TOL $\pm 3.0^\circ$		INITIAL REVISION:		SHEET NUMBER	
		DRWN: GGUNAGI 2016/11/09		17 OF 21	
		APPR: ISHWARG 2016/12/06		MATERIAL NUMBER	
DRAFT WHERE APPLICABLE MUST REMAIN WITHIN DIMENSIONS		THIRD ANGLE PROJECTION	DRAWING	SERIES	CUSTOMER
			A3-SIZE	87898	GENERAL MARKET

CKT	DIMENSION				
	Bo	Ao	Ko	F	W
5	13.10	5.20	11.30	11.50	24.00

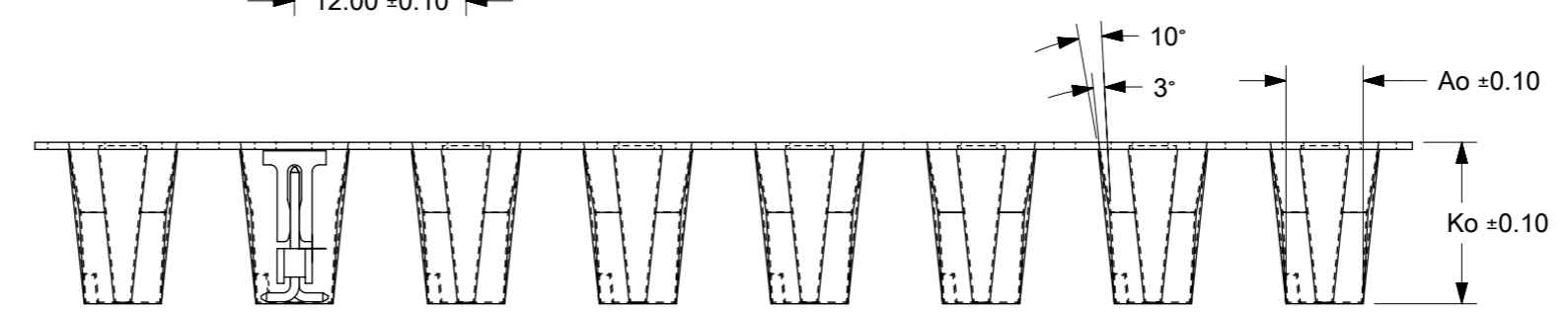
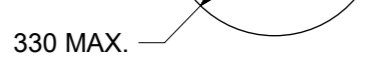

NOTES:
1. LEADER AND TRAILER TAPE

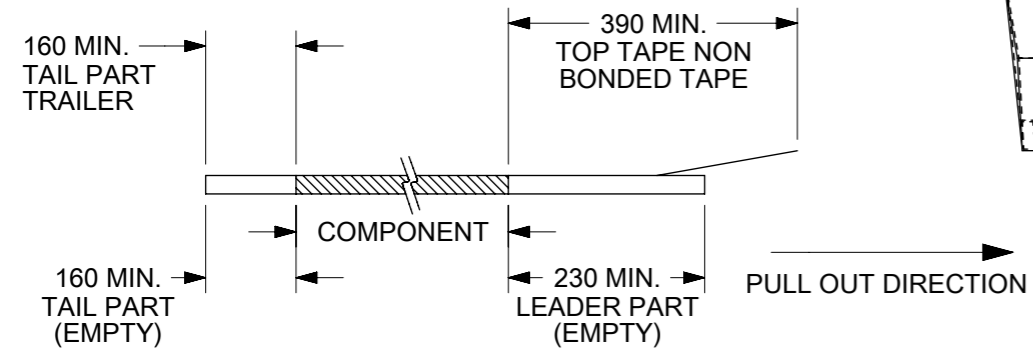

PART PACK
IN E/TAPE
ORIENTATION
(FOR REF USE)

2. PEELING OFF FORCE OF THE TOP TAPE: 20 - 80gf.
(PEELING DIRECTION AS SHOWN IN FOLLOWING FIGURE)

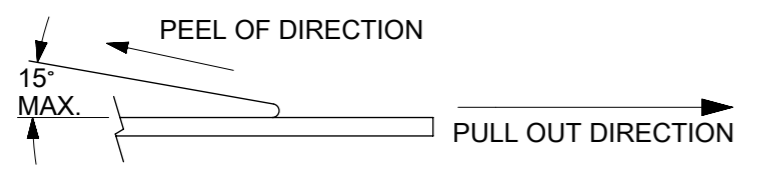

- MATERIAL: BLACK P.S CONDUCTIVE, BLACK
- MEASURED FROM CENTRELINE OF SPROCKET HOLE TO CENTRELINE OF SPOCKET
- CUMULATIVE TOLERANCE OF 10 SPROCKET HOLE IS ±0.20mm
- A0 AND B0 ARE MEASURE FROM ABOVE POCKET BASE 0.30mm
- TAPE AND REEL SPECIFICATION IS AS PER EIA-481.
- TAPE AND REEL QUANTITY : 440PCS/REEL
- THE TAPE IS TREATED FOR ANTI-STATIC.
- ALL RADIUS ARE 0.30MM UNLESS SPECIFY
- SURFACE RESISTIVITY 10³ TO 10 OHMS.

THIS DRAWING CONTAINS INFORMATION THAT IS PROPRIETARY TO MOLEX ELECTRONIC TECHNOLOGIES, LLC AND SHOULD NOT BE USED WITHOUT WRITTEN PERMISSION		CURRENT REV DESC:		molex	
DIMENSION UNITS	SCALE	EC NO: 745488			
mm	NTS	DRWN: SUAIFR		2.54MM PITCH SINGLE ROW SINGLE WAFER SMT HEADER	
GENERAL TOLERANCES (UNLESS SPECIFIED)		CHK'D: SUAIFR		PRODUCT CUSTOMER DRAWING	
		APPR: MRAMAKRISHNA		DOCUMENT NUMBER	
		INITIAL REVISION:		DOC TYPE	
		DRWN: GGUNAGI		DOC PART	
		APPR: ISHWARG		REVISION	
		SERIES		SD-87898-001	
		MATERIAL NUMBER		PSD	
		CUSTOMER		000	
		SHEET NUMBER		B26	
DRAFT WHERE APPLICABLE MUST REMAIN WITHIN DIMENSIONS		THIRD ANGLE PROJECTION		SEE TABLE	
		DRAWING		GENERAL MARKET	
		A3-SIZE		18 OF 21	
		87898			

10
9
8
7
6
5
4
3
2
1

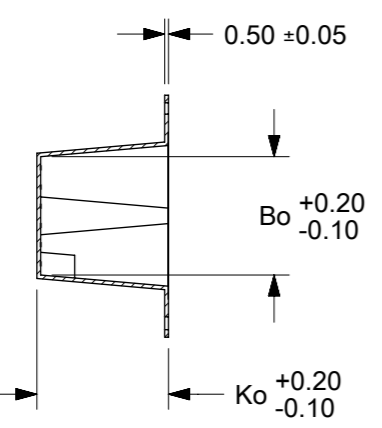

CKT	DIMENSION							TYPE	QTY/ REEL
	M	Bo	So	Ao	Ko	F	W		
6	11.50	15.65	28.40	5.20	16.90	14.20	32.00	A	150
6	5.84	15.65	28.40	5.20	11.30	14.20	32.00	B	440
8		20.70	40.40	5.20	11.30	20.20	44.00		
10		25.80	40.40	5.20	11.30	20.20	44.00		
12		30.90	52.40	5.20	11.30	26.20	56.00		
14		35.95	52.40	5.20	11.30	26.20	56.00		
16		41.05	52.40	5.20	11.30	26.20	56.00		
18		46.20	68.40	5.20	11.30	34.20	72.00		
20		51.20	68.40	5.20	11.30	34.20	72.00		

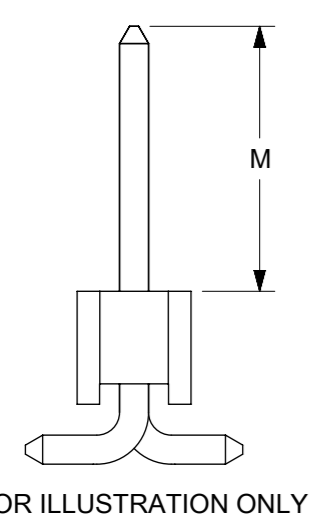

NOTES:
1. LEADER AND TRAILER TAPE

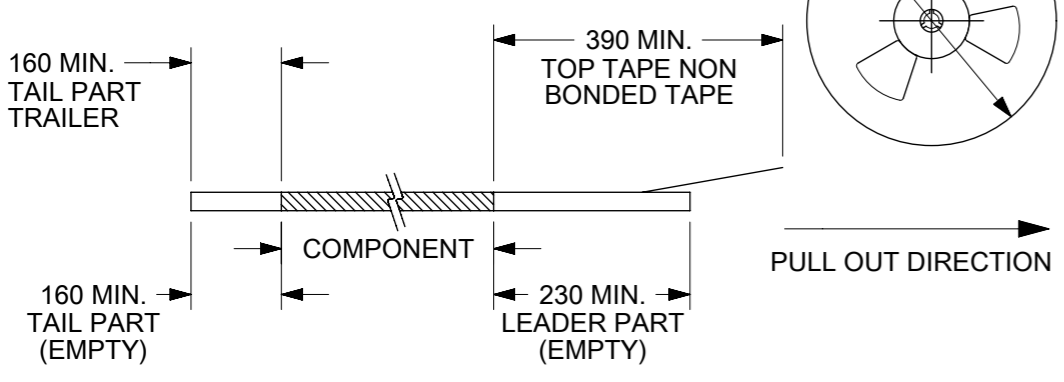

2. PEELING OFF FORCE OF THE TOP TAPE: 20 - 80gf.
(PEELING DIRECTION AS SHOWN IN FOLLOWING FIGURE)

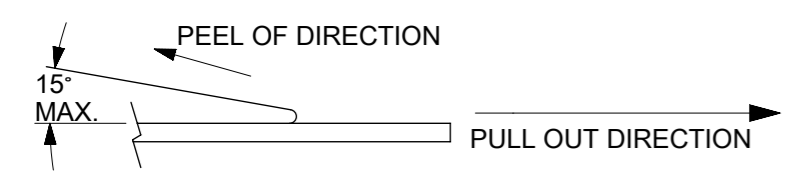

- 3. MATERIAL: BLACK P.S CONDUCTIVE, BLACK
- 4. MEASURED FROM CENTRELINE OF SPROCKET HOLE TO CENTRELINE OF SPOCKET
- 5. CUMULATIVE TOLERANCE OF 10 SPROCKET HOLE IS ±0.20mm
- 6. A0 AND B0 ARE MEASURE FROM ABOVE POCKET BASE 0.30mm
- 7. TAPE AND REEL SPECIFICATION IS AS PER EIA-481.
- 8. TAPE AND REEL QUANTITY : SEE TABLE
- 9. THE TAPE IS TREATED FOR ANTI-STATIC.
- 10. ALL RADIUS ARE 0.30MM UNLESS SPECIFY
- 11. SURFACE RESISTIVITY 10³ TO 10 OHMS.

TYPE B

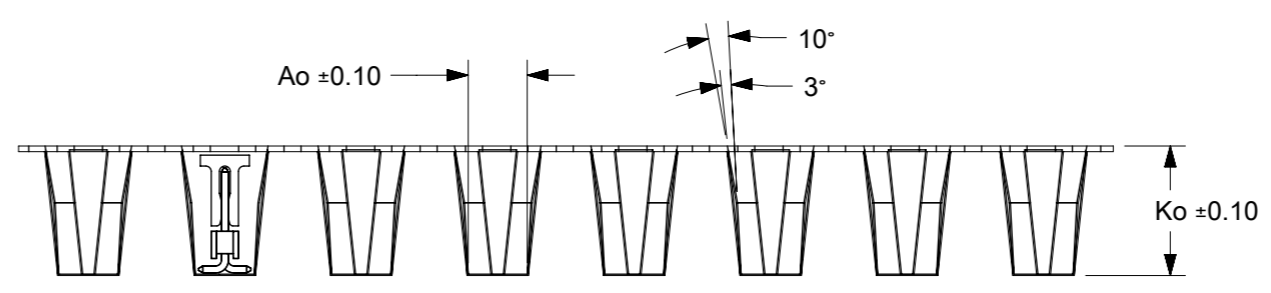
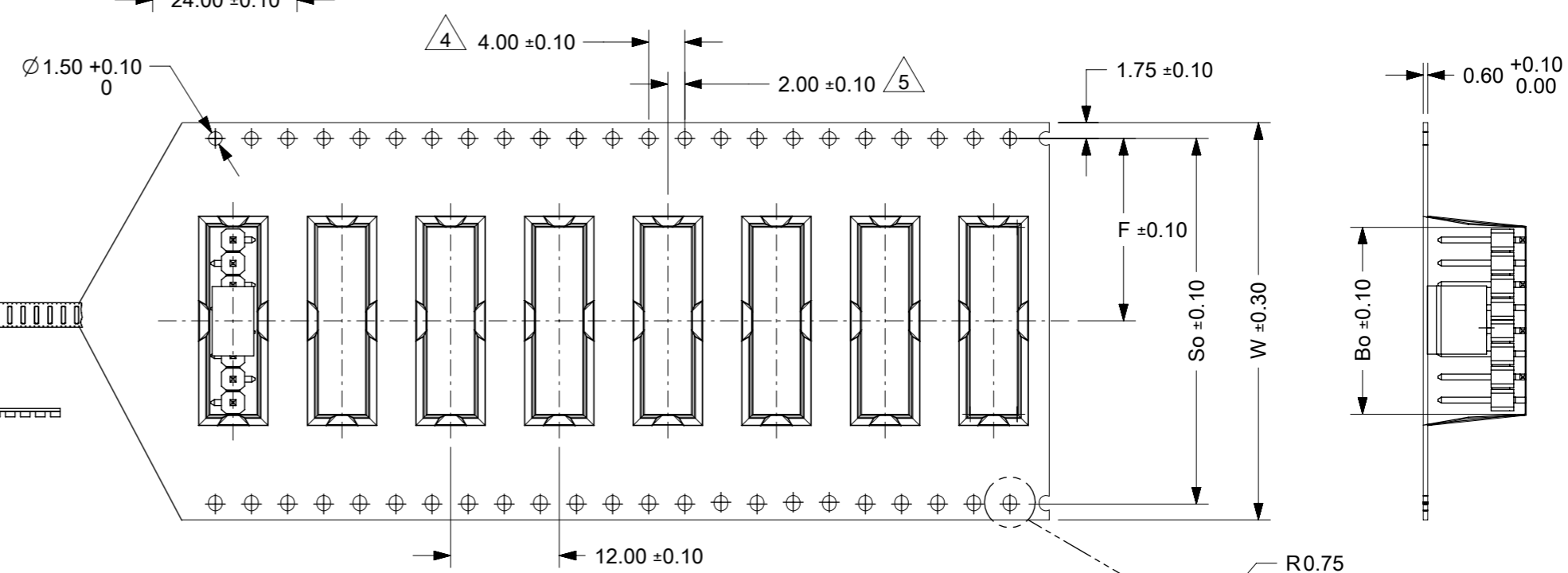

PART PACK IN E/TAPE ORIENTATION(FOR REF USE)

THIS DRAWING CONTAINS INFORMATION THAT IS PROPRIETARY TO MOLEX ELECTRONIC TECHNOLOGIES, LLC AND SHOULD NOT BE USED WITHOUT WRITTEN PERMISSION

DIMENSION UNITS	SCALE	CURRENT REV DESC:	
mm	NTS		
GENERAL TOLERANCES (UNLESS SPECIFIED)			
	MM	INCH	
4 PLACES	±	±	
3 PLACES	±	±	
2 PLACES	±	0.2	±
1 PLACE	±	±	
0 PLACES	±	±	
ANGULAR TOL ± 3.0°			
DRAFT WHERE APPLICABLE MUST REMAIN WITHIN DIMENSIONS		THIRD ANGLE PROJECTION	DRAWING
			A3-SIZE
		SERIES	87898
		MATERIAL NUMBER	SEE TABLE
		CUSTOMER	GENERAL MARKET
		SHEET NUMBER	19 OF 21

EC NO: 745488
DRWN: SUAIFR 2023/02/15
CHK'D: SUAIFR 2023/04/10
APPR: MRAMAKRISHNA 2023/04/10

INITIAL REVISION:
DRWN: GGUNAGI 2016/11/09
APPR: ISHWARG 2016/12/06

DOCUMENT NUMBER: SD-87898-001
DOC TYPE: PSD
DOC PART: 000
REVISION: B26

PRODUCT CUSTOMER DRAWING

9
8
7
6
5
4
3
2
1



CKT	DIMENSION					
	Bo	So	Ao	Ko	F	W
7	18.20	40.40	5.20	11.30	20.20	44.00
9	23.25	40.40	5.20	11.30	20.20	44.00
11	28.35	40.40	5.20	11.30	20.20	44.00
13	33.40	52.40	5.20	11.30	26.20	56.00
15	38.50	52.40	5.20	11.30	26.20	56.00
17	43.60	68.40	5.20	11.30	34.20	72.00
19	48.70	68.40	5.20	11.30	34.20	72.00
21	53.80	68.40	5.20	11.30	34.20	72.00

THIS DRAWING CONTAINS INFORMATION THAT IS PROPRIETARY TO MOLEX ELECTRONIC TECHNOLOGIES, LLC AND SHOULD NOT BE USED WITHOUT WRITTEN PERMISSION

DIMENSION UNITS	SCALE	CURRENT REV DESC:	
mm	NTS		
GENERAL TOLERANCES (UNLESS SPECIFIED)			
	MM	INCH	
4 PLACES	±	±	
3 PLACES	±	±	
2 PLACES	± 0.2	±	
1 PLACE	±	±	
0 PLACES	±	±	
ANGULAR TOL	± 3.0°		
DRAFT WHERE APPLICABLE MUST REMAIN WITHIN DIMENSIONS		THIRD ANGLE PROJECTION	DRAWING
			A3-SIZE
		SERIES	87898
		MATERIAL NUMBER	SEE TABLE
		CUSTOMER	GENERAL MARKET
		SHEET NUMBER	20 OF 21

EC NO: 745488
 DRWN: SUAIFR 2023/02/15
 CHK'D: SUAIFR 2023/04/10
 APPR: MRAMAKRISHNA 2023/04/10

INITIAL REVISION:
 DRWN: GGUNAGI 2016/11/09
 APPR: ISHWARG 2016/12/06

molex
 CUSTOM HEADER
 2.54MM PITCH SINGLE ROW SINGLE WAFER SMT HEADER

PRODUCT CUSTOMER DRAWING

DOCUMENT NUMBER: SD-87898-001
 DOC TYPE: PSD
 DOC PART: 000
 REVISION: B26

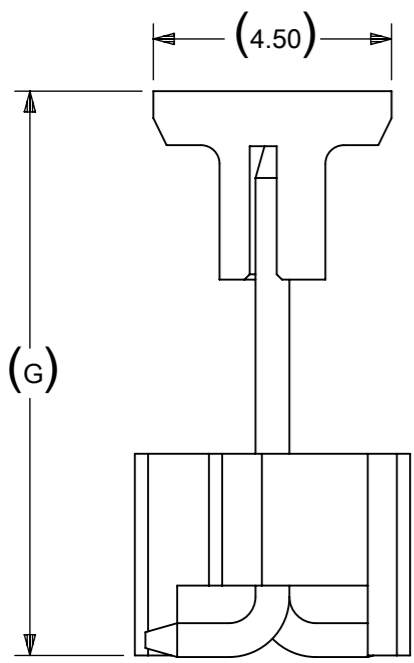
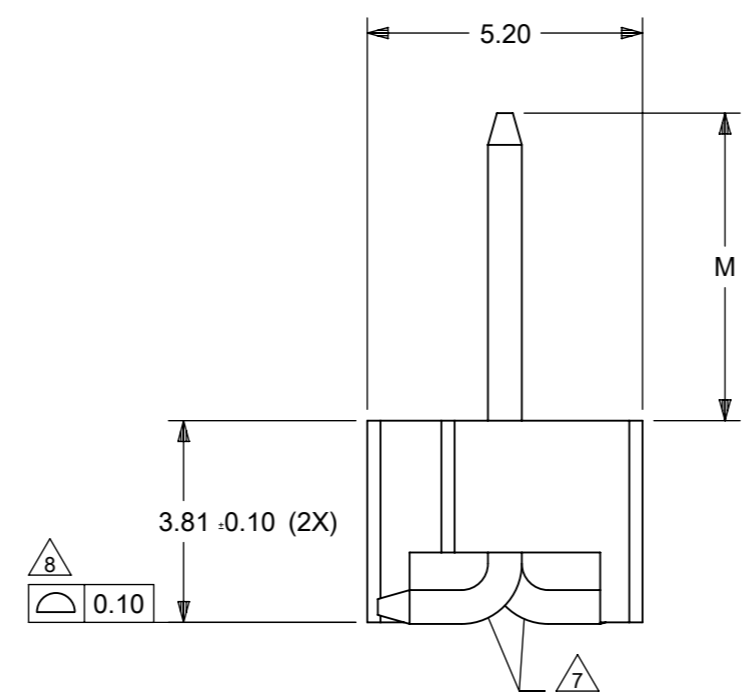
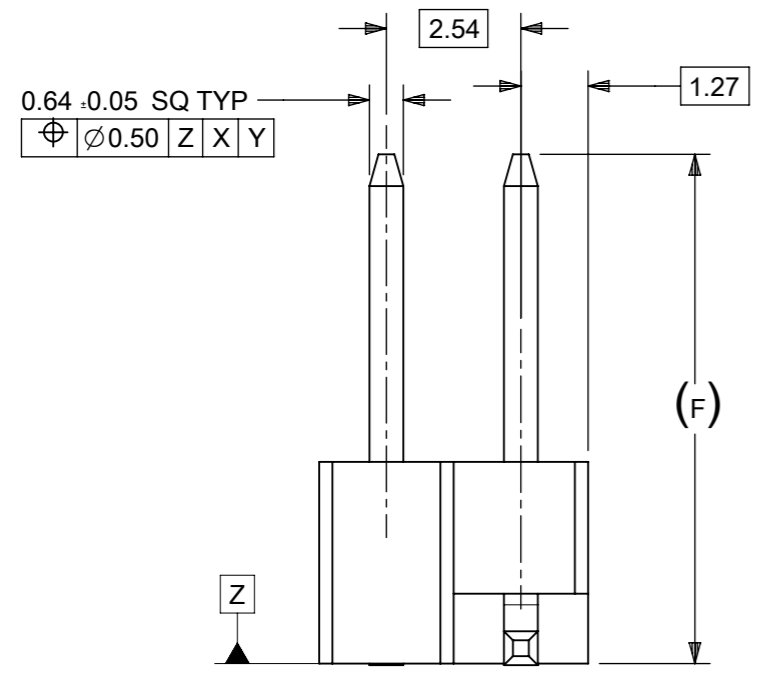
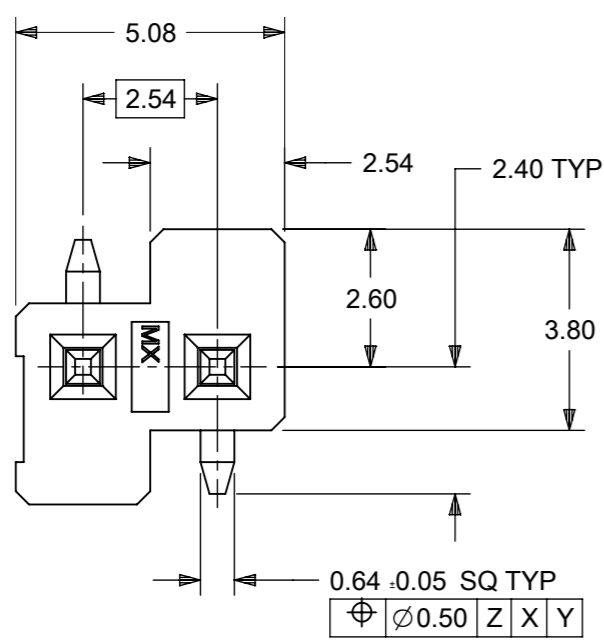

CONN WITH CAP

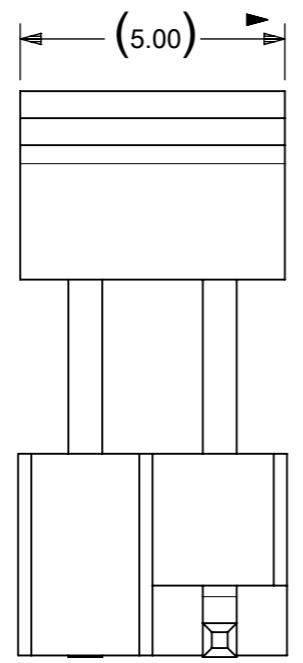

CONN WITH CAP

PACKAGING OPTION PART NO.						CKT SIZE	PLATING TYPE	DIMENSION			CAP (SEE SHEET-16)
TRAY WITHOUT CAP	TRAY WITH CAP	TUBE WITHOUT CAP	TUBE WITH CAP	TAPE & REEL WITHOUT CAP	TAPE & REEL WITH CAP			G	F	M	
-----	-----	-----	-----	-----	87898-0218	2	4	10.69	9.65	5.84	2
-----	-----	-----	-----	-----	87898-0219	2	6	10.69	9.65	5.84	2
-----	-----	-----	87898-0220	-----	-----	2	6	10.64	9.60	5.84	-
-----	-----	-----	-----	-----	87898-0221	2	6	24.53	23.49	19.73	-

ONLY APPLICABLE TO 2CKT SIZE

NOTES:

- MATERIAL:
HSG: LCP, GLASS-FILLED, UL94V-0, COLOR: BLACK
CAP: NYLON, GLASS-FILLED, UL94V-0, COLOR: BLACK
PIN: 0.64MM SQ, COPPER ALLOY
- PLATING TYPE:
(1) GOLD FLASH OVER
1.25µm MIN. NICKEL OVERALL.
(2) GOLD FLASH ON CONTACT AND
2.50µm MIN. TIN ON SOLDER TAIL OVER
1.25µm MIN. NICKEL OVERALL.
(4) 0.38µm MIN. GOLD PLATE ON CONTACT AND
2.00µm MIN. TIN ON SOLDER TAIL OVER
1.25µm MIN. NICKEL OVERALL.
(5) 0.75µm MIN. GOLD PLATE ON CONTACT AND
2.00µm MIN. TIN ON SOLDER TAIL OVER
1.25µm MIN. NICKEL OVERALL.
(6) 2.50µm MIN. TIN OVERALL
1.25µm MIN. NICKEL OVERALL
- PRODUCT SPECIFICATION: PS-87920-019
- PACKAGING TYPE: SEE TABLE
- PACKAGING SPEC:
TUBE WITH CAP VERSION: PK-89990-558
TUBE W/O CAP VERSION: PK-89990-545
EMBOSS TAPE WITH CAP: PK-87898-400
- WAFER TO BE FLAT WITHIN 0.003 mm/mm
- BEND DEPRESSION IS ACCEPTED SO LONG AS IT DOES NOT AFFECT THE OVERALL COPLANARITY OF TAIL
- COPLANARITY IS TO BE MEASURED BY RESTING THE SOLDER TAIL ON A FLAT SURFACE
- CAP LOCATION IS CENTERED ALONG THE MATING ENDS AS SHOWN. TOP SURFACE OF CAP TO BE FLAT FOR THE PURPOSE OF PICK & PLACE BY VACUUM SUCTION NOZZLE
- RECOMMENDED PCB THICKNESS IS 1.60mm±0.10

THIS DRAWING CONTAINS INFORMATION THAT IS PROPRIETARY TO MOLEX ELECTRONIC TECHNOLOGIES, LLC AND SHOULD NOT BE USED WITHOUT WRITTEN PERMISSION											
DIMENSION UNITS		SCALE		CURRENT REV DESC:							
mm		NTS									
GENERAL TOLERANCES (UNLESS SPECIFIED)				EC NO: 745488		DRWN: SUIFR		2023/02/15		CUSTOM HEADER 2.54MM PITCH SINGLE ROW SINGLE WAFER SMT HEADER	
				CHK'D: SUIFR		2023/04/10					
4 PLACES ±				APP'R: MRAMAKRISHNA		2023/04/10		PRODUCT CUSTOMER DRAWING			
3 PLACES ±				INITIAL REVISION:		DRWN: GGUNAGI		2016/11/09		DOCUMENT NUMBER	
2 PLACES ± 0.2				APP'R: ISHWARG		2016/12/06		SD-87898-001		DOC TYPE DOC PART REVISION	
1 PLACE ±				DRAFT WHERE APPLICABLE MUST REMAIN WITHIN DIMENSIONS		THIRD ANGLE PROJECTION		DRAWING		SERIES	
0 PLACES ±				ANGULAR TOL ± 3.0°		A3-SIZE		87898		MATERIAL NUMBER CUSTOMER SHEET NUMBER	
DOCUMENT STATUS		P1		RELEASE DATE		2023/04/10		07:46:21		SEE TABLE GENERAL MARKET 21 OF 21	

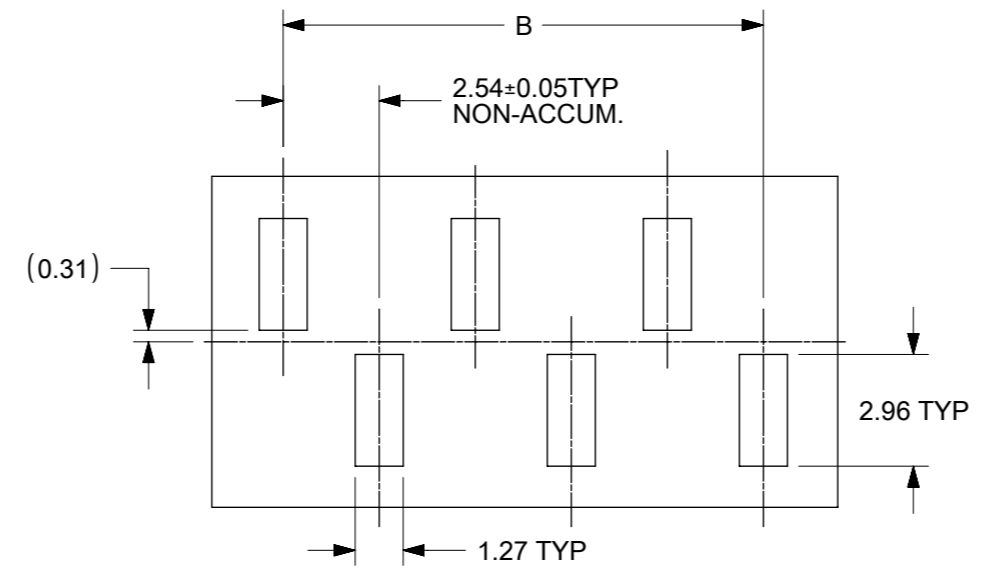
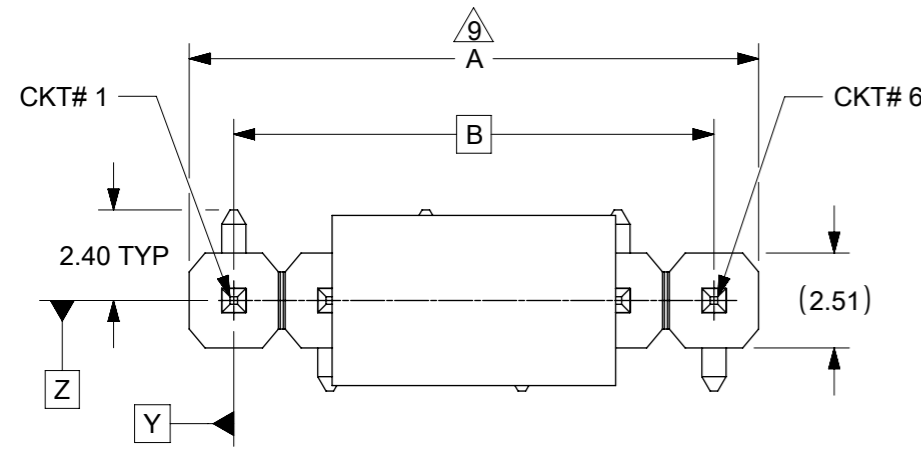

RECOMMENDED PCB LAYOUT

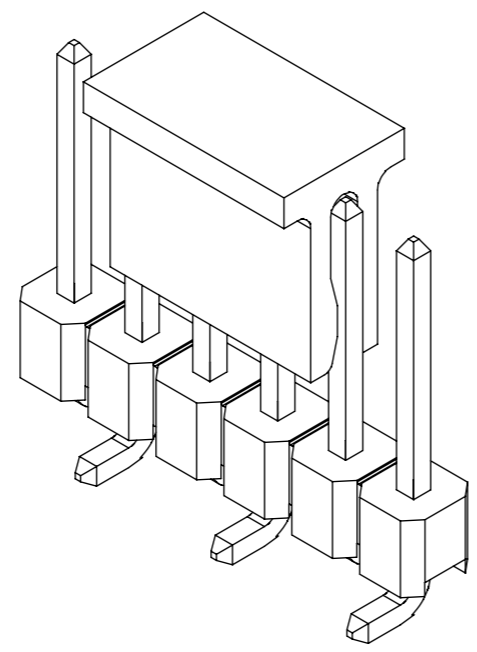
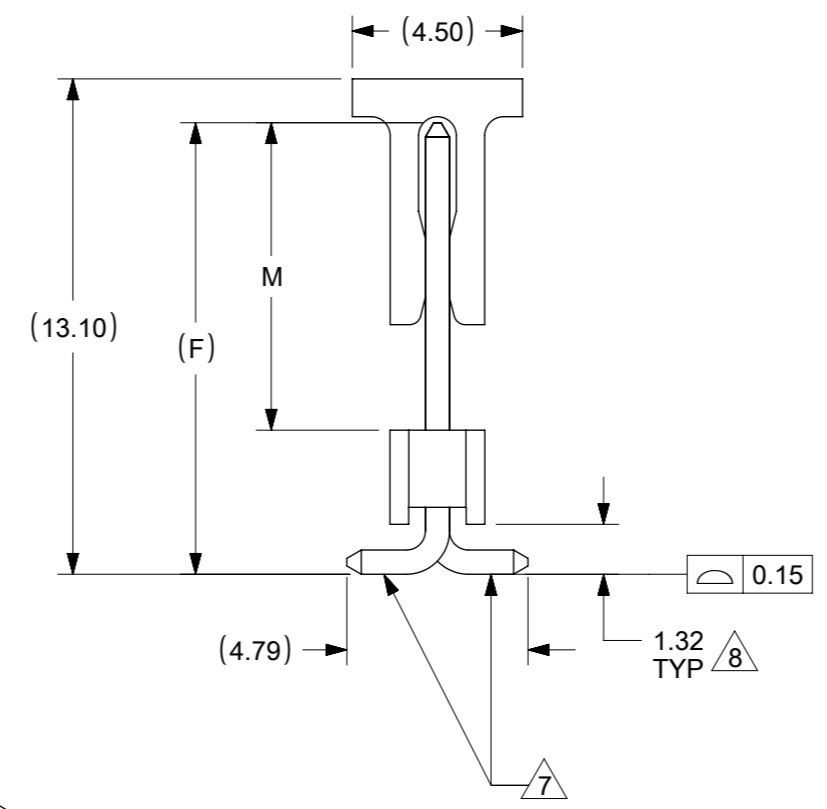
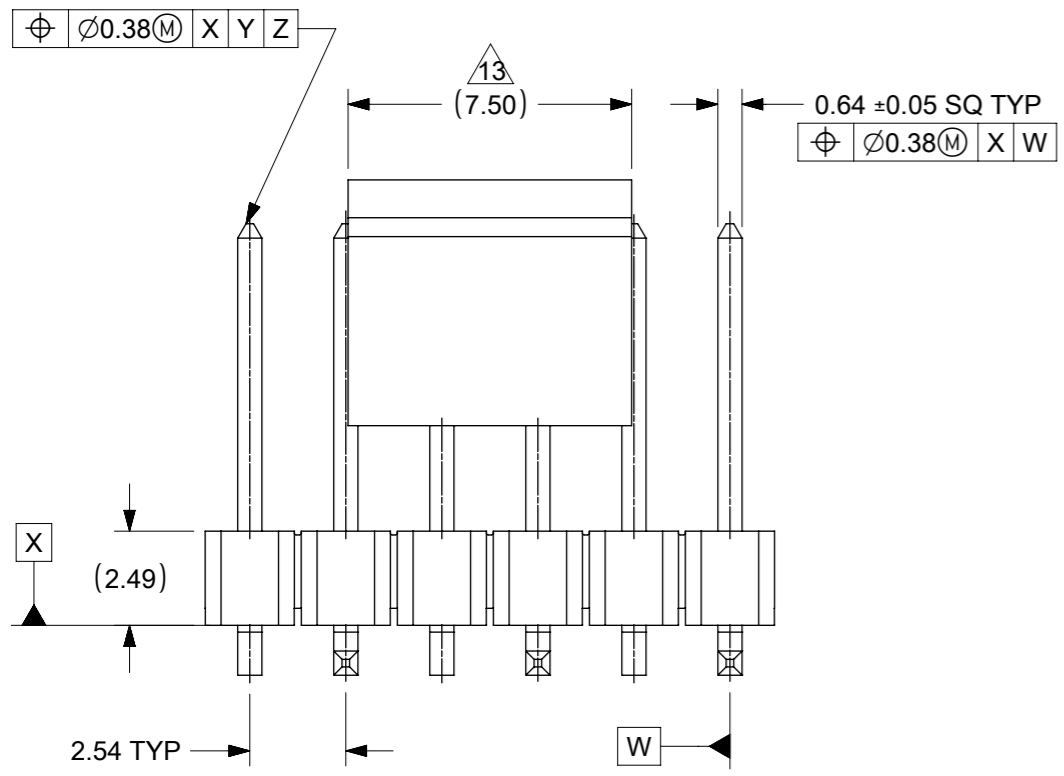

NOTES:

1. MATERIAL:
HSG: NYLON, GLASS-FILLED, UL94V-0, COLOR: BLACK
PIN: 0.64MM SQ, COPPER ALLOY
2. PLATING TYPE:
 - (1) GOLD FLASH OVER
1.25µm MIN. NICKEL OVERALL.
 - (2) GOLD FLASH ON CONTACT AND
2.50µm MIN. TIN ON SOLDER TAIL OVER
1.25µm MIN. NICKEL OVERALL.
 - (4) 0.38µm MIN. GOLD PLATE ON CONTACT AND
2.00µm MIN. TIN ON SOLDER TAIL OVER
1.25µm MIN. NICKEL OVERALL.
 - (5) 0.75µm MIN. GOLD PLATE ON CONTACT AND
2.00µm MIN. TIN ON SOLDER TAIL OVER
1.25µm MIN. NICKEL OVERALL.
 - (6) 2.50µm MIN. TIN OVERALL
1.25µm MIN. NICKEL OVERALL
3. PRODUCT SPECIFICATION: PS-87920-019
4. PACKAGING TYPE: SEE TABLE
5. PACKAGING SPEC: PK-89990-545(TUBE), PK-89990-486(T&R) & PK-87898-400 (T&R)
6. WAFER TO BE FLAT WITHIN 0.003 mm/mm
7. BEND DEPRESSION IS ACCEPTED SO LONG AS IT DOES NOT AFFECT THE OVERALL COPLANARITY OF TAIL
8. COPLANARITY IS TO BE MEASURED BY RESTING THE SOLDER TAIL ON A FLAT SURFACE
9. IRREGULAR CIRCUIT CUTOFF WITHIN BREAKAWAY SECTION IS PERMISSIBLE. CUTTING OR CHIPPING OF THE MAIN BODY IS NOT ACCEPTABLE
10. TUBE LENGTH AS PER STANDARD 560mm
11. RECOMMENDED PCB THICKNESS IS 1.60mm±0.10
12. THE ABOVE CKT 6 IS FOR ILLUSTRATION PURPOSE ONLY
13. CAP LOCATION IS CENTERED ALONG THE MATING ENDS AS SHOWN. TOP SURFACE OF CAP TO BE FLAT FOR THE PURPOSE OF PICK & PLACE BY VACUUM SUCTION NOZZLE.

THIS DRAWING CONTAINS INFORMATION THAT IS PROPRIETARY TO MOLEX ELECTRONIC TECHNOLOGIES, LLC AND SHOULD NOT BE USED WITHOUT WRITTEN PERMISSION		CURRENT REV DESC:		molex	
DIMENSION UNITS: mm		SCALE: NTS			
GENERAL TOLERANCES (UNLESS SPECIFIED)		EC NO: 698212		2.54MM PITCH SINGLE ROW SINGLE WAFER SMT HEADER	
		DRWN: DANUSA 2022/03/03		PRODUCT CUSTOMER DRAWING	
		CHK'D: DANUSA 2022/03/04		DOCUMENT NUMBER	
		APPR: MRAMAKRISHNA 2022/03/04		SD-87898-003	
		INITIAL REVISION:		DOC TYPE	
		DRWN: SKLIM01 2005/10/26		PSD	
		APPR: PTLIM 2005/11/07		DOC PART	
		ANGULAR TOL ± 3.0°		001	
DRAFT WHERE APPLICABLE MUST REMAIN WITHIN DIMENSIONS		THIRD ANGLE PROJECTION		REVISION	
		DRAWING: A3-SIZE		C1	
		SERIES: 87898		SHEET NUMBER	
		MATERIAL NUMBER: SEE TABLE		1 OF 17	
		CUSTOMER: GENERAL MARKET			

9 8 7 6 5 4 3 2 1

E
D
C
B
A

PART WITHOUT CAP
IN TUBE
ORIENTATION

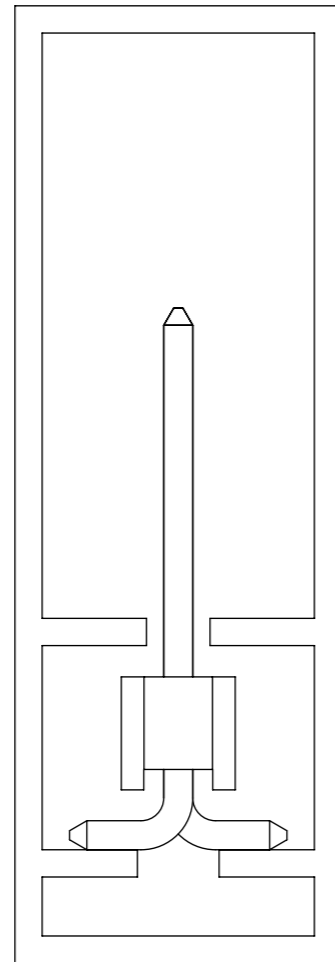

PART WITH CAP
IN TUBE
ORIENTATION

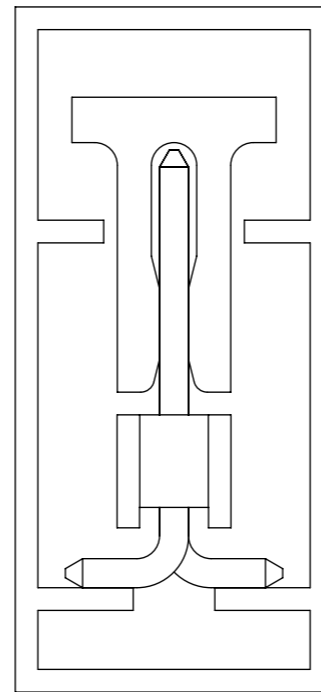

THIS DRAWING CONTAINS INFORMATION THAT IS PROPRIETARY TO MOLEX ELECTRONIC TECHNOLOGIES, LLC AND SHOULD NOT BE USED WITHOUT WRITTEN PERMISSION									
DIMENSION UNITS		SCALE		CURRENT REV DESC:				molex	
mm		NTS							
GENERAL TOLERANCES (UNLESS SPECIFIED)				EC NO: 698212				CUSTOM HEADER 2.54MM PITCH SINGLE ROW SINGLE WAFER SMT HEADER	
		MM	INCH	DRWN: DANUSA		2022/03/03			
4 PLACES		±	±	CHK'D: DANUSA		2022/03/04		PRODUCT CUSTOMER DRAWING	
3 PLACES		±	±	APPR: MRAMAKRISHNA		2022/03/04			
2 PLACES		± 0.2	±	INITIAL REVISION:				DOCUMENT NUMBER	
1 PLACE		±	±	DRWN: SKLIM01		2005/10/26		SD-87898-003	
0 PLACES		±	±	APPR: PTLIM		2005/11/07		DOC TYPE	DOC PART
ANGULAR TOL		± 3.0°		THIRD ANGLE PROJECTION		DRAWING	SERIES	MATERIAL NUMBER	CUSTOMER
DRAFT WHERE APPLICABLE MUST REMAIN WITHIN DIMENSIONS		THIRD ANGLE PROJECTION		DRAWING		SERIES	MATERIAL NUMBER	CUSTOMER	SHEET NUMBER
				A3-SIZE		87898	SEE TABLE	GENERAL MARKET	2 OF 17

DOCUMENT STATUS	P1	RELEASE DATE	2022/03/04	09:00:56
-----------------	----	--------------	------------	----------

9 8 7 6 5 4 3 2 1

FORMAT: Mef-lega-master-ib-prod-A3
REVISION: D
DATE: 2018/01/18

CKT	DIMENSION						QTY/REEL
	Bo	Ao	Ko	F	So	W	
3	8.02	5.20	13.60	11.50	--	24.00	320
4	10.51	5.79	15.05	14.20	28.40	32.00	250
5	13.10	5.20	13.60	11.50	---	24.00	320

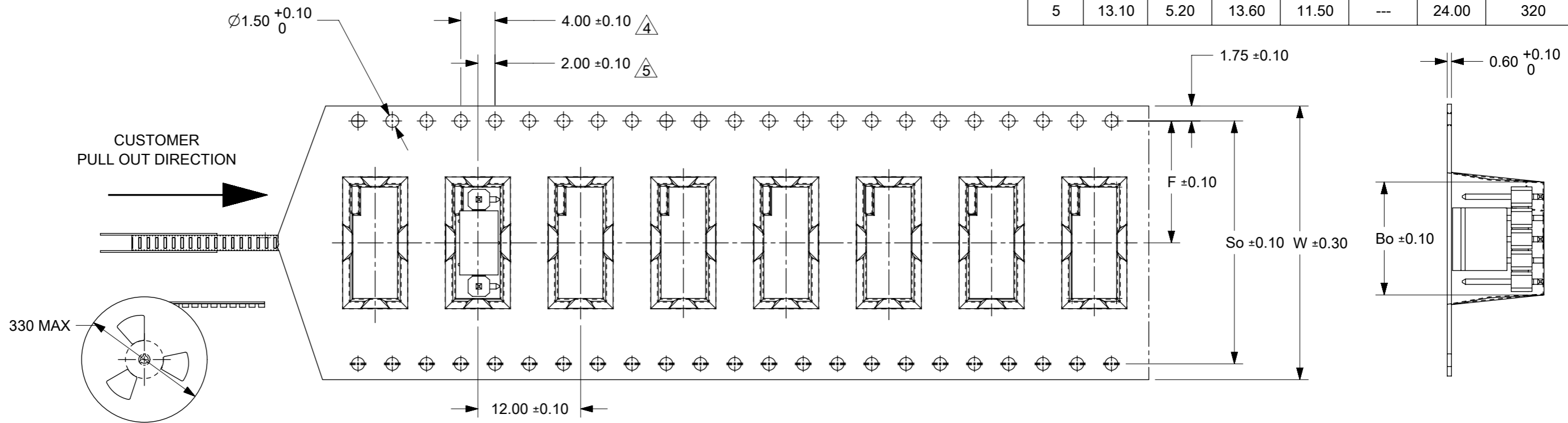

NOTES:

1. LEADER AND TRAILER TAPE

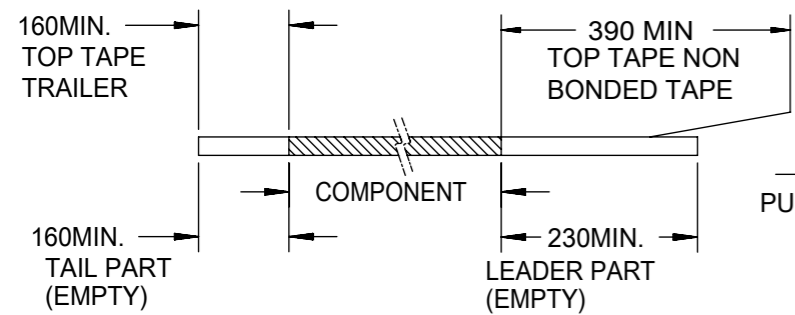

2. PEELING OFF FORCE OF THE TOP TAPE: 20 - 80gf. (PEELING DIRECTION AS SHOWN IN FOLLOWING FIGURE)

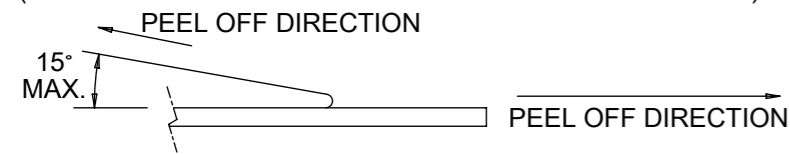

- 3. MATERIAL: BLACK P.S CONDUCTIVE, BLACK
- 4. MEASURED FROM CENTRELINE OF SPROCKET HOLE TO CENTRELINE OF POCKET
- 5. CUMULATIVE TOLERANCE OF 10 SPROCKET HOLE IS $\pm 0.20\text{mm}$
- 6. A0 AND B0 ARE MEASURE FROM ABOVE POCKET BASE 0.30mm
- 7. TAPE AND REEL SPECIFICATION IS AS PER EIA-481.
- 8. THE TAPE IS TREATED FOR ANTI-STATIC.
- 9. ALL RADIUS ARE 0.30MM UNLESS SPECIFY
- 10. SURFACE RESISTIVITY 10^3 TO 10 OHMS.

THIS DRAWING CONTAINS INFORMATION THAT IS PROPRIETARY TO MOLEX ELECTRONIC TECHNOLOGIES, LLC AND SHOULD NOT BE USED WITHOUT WRITTEN PERMISSION

DIMENSION UNITS	SCALE	CURRENT REV DESC:		molex		
mm	NTS					
GENERAL TOLERANCES (UNLESS SPECIFIED)		EC NO: 698212		CUSTOMER		
		DRWN: DANUSA 2022/03/03		2.54MM PITCH SINGLE ROW SINGLE WAFER SMT HEADER		
		CHK'D: DANUSA 2022/03/04		PRODUCT CUSTOMER DRAWING		
		APPR: MRAMAKRISHNA 2022/03/04		DOCUMENT NUMBER		
		INITIAL REVISION:		SD-87898-003		
		DRWN: SKLIM01 2005/10/26		DOC TYPE		
		APPR: PTLIM 2005/11/07		PSD		
		ANGULAR TOL $\pm 3.0^\circ$		DOC PART		
		DRAFT WHERE APPLICABLE MUST REMAIN WITHIN DIMENSIONS		001		
		THIRD ANGLE PROJECTION		REVISION		
		DRAWING		C1		
		SERIES		SHEET NUMBER		
		A3-SIZE 87898		3 OF 17		
		MATERIAL NUMBER		CUSTOMER		
		SEE TABLE		GENERAL MARKET		

9 8 7 6 5 4 3 2 1

PACKAGING OPTION PART NO.						CKT SIZE	VOID POSITION	PLATING TYPE	DIMENSION			
TRAY WITHOUT CAP	TRAY WITH CAP	TUBE WITHOUT CAP	TUBE WITH CAP	TAPE & REEL WITHOUT CAP	TAPE & REEL WITH CAP				A	B	F	M
-----	(C) 87898-0361	-----	-----	-----	-----	3	----	1	7.62	5.08	11.94	8.13
-----	(C) 87898-0362	-----	-----	-----	-----	3	----	2	7.62	5.08	11.94	8.13
-----	(C) 87898-0364	-----	-----	-----	87898-0369	3	----	4	7.62	5.08	11.94	8.13
-----	(C) 87898-0365	-----	-----	-----	-----	3	----	5	7.62	5.08	11.94	8.13
-----	(C) 87898-0366	-----	87898-0367	-----	87898-0368	3	----	6	7.62	5.08	11.94	8.13

E

E

D

D

C

C

B

B

A

A

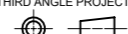
THIS DRAWING CONTAINS INFORMATION THAT IS PROPRIETARY TO MOLEX ELECTRONIC TECHNOLOGIES, LLC AND SHOULD NOT BE USED WITHOUT WRITTEN PERMISSION													
DIMENSION UNITS		SCALE		CURRENT REV DESC:									
mm		NTS											
GENERAL TOLERANCES (UNLESS SPECIFIED)				EC NO: 698212 DRWN: DANUSA 2022/03/03 CHK'D: DANUSA 2022/03/04 APPR: MRAMAKRISHNA 2022/03/04						CUSTOM HEADER 2.54MM PITCH SINGLE ROW SINGLE WAFER SMT HEADER			
		MM	INCH										
4 PLACES	±		±	INITIAL REVISION: DRWN: SKLIM01 2005/10/26 APPR: PTLIM 2005/11/07						PRODUCT CUSTOMER DRAWING DOCUMENT NUMBER: SD-87898-003 DOC TYPE: PSD DOC PART: 001 REVISION: C1			
3 PLACES	±		±										
2 PLACES	±	0.2	±	DRAFT WHERE APPLICABLE MUST REMAIN WITHIN DIMENSIONS						THIRD ANGLE PROJECTION 			
1 PLACE	±		±										
0 PLACES	±		±	DRAWING		SERIES		MATERIAL NUMBER		CUSTOMER			
ANGULAR TOL ± 3.0°				A3-SIZE		87898		SEE TABLE		GENERAL MARKET			
SHEET NUMBER				4 OF 17									

DOCUMENT STATUS	P1	RELEASE DATE	2022/03/04	09:00:56
-----------------	----	--------------	------------	----------

9 8 7 6 5 4 3 2 1

FORMAT: Mel-lega-master-ib-prod-A3
 REVISION: D
 DATE: 2018/01/18

PACKAGING OPTION PART NO.						CKT SIZE	PEG	VOID POSITION	PLATING TYPE	DIMENSION			
TRAY WITHOUT CAP	TRAY WITH CAP	TUBE WITHOUT CAP	TUBE WITH CAP	TAPE & REEL WITHOUT CAP	TAPE & REEL WITH CAP					A	B	F	M
-----	-----	87898-0461	-----	-----	-----	4	---	----	1	10.16	7.62	11.94	8.13
-----	-----	87898-0462	-----	-----	-----	4	---	----	2	10.16	7.62	11.94	8.13
-----	-----	87898-0464	-----	-----	-----	4	---	----	4	10.16	7.62	11.94	8.13
-----	-----	87898-0465	-----	-----	-----	4	---	----	5	10.16	7.62	11.94	8.13
-----	-----	87898-0466	-----	-----	87898-0467	4	---	----	6	10.16	7.62	11.94	8.13
-----	-----	-----	-----	-----	87898-0468	4	Y	----	6	10.16	7.62	11.94	8.13
-----	-----	-----	-----	87898-0489	-----	4	Y	----	5	10.16	7.62	16.74	12.93
-----	-----	87898-0561	-----	-----	-----	5	---	----	1	12.70	10.16	11.94	8.13
-----	-----	87898-0562	-----	-----	-----	5	---	----	2	12.70	10.16	11.94	8.13
-----	-----	87898-0564	-----	-----	-----	5	---	----	4	12.70	10.16	11.94	8.13
-----	-----	87898-0565	-----	-----	-----	5	---	----	5	12.70	10.16	11.94	8.13
-----	-----	87898-0566	87898-0567	-----	87898-0568	5	---	----	6	12.70	10.16	11.94	8.13
-----	-----	87898-0661	-----	-----	-----	6	---	----	1	15.24	12.70	11.94	8.13
-----	-----	87898-0662	-----	-----	-----	6	---	----	2	15.24	12.70	11.94	8.13
-----	-----	87898-0664	-----	-----	-----	6	---	----	4	15.24	12.70	11.94	8.13
-----	-----	87898-0665	-----	-----	(C) -----	6	---	----	5	15.24	12.70	11.94	8.13
-----	-----	87898-0666	-----	-----	87898-0605	6	---	----	6	15.24	12.70	11.94	8.13

4 CKT WITH PEG FOR ILLUSTRATION ONLY

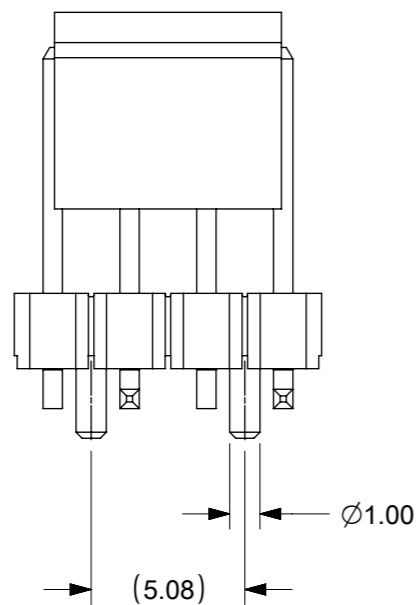

THIS DRAWING CONTAINS INFORMATION THAT IS PROPRIETARY TO MOLEX ELECTRONIC TECHNOLOGIES, LLC AND SHOULD NOT BE USED WITHOUT WRITTEN PERMISSION											
DIMENSION UNITS		SCALE		CURRENT REV DESC:							
mm		NTS		EC NO: 698212							
GENERAL TOLERANCES (UNLESS SPECIFIED)				DRWN: DANUSA		2022/03/03		CUSTOM HEADER 2.54MM PITCH SINGLE ROW SINGLE WAFER SMT HEADER			
4 PLACES ±		±		CHK'D: DANUSA		2022/03/04					
3 PLACES ±		±		APPR: MRAMAKRISHNA		2022/03/04		PRODUCT CUSTOMER DRAWING			
2 PLACES ±		0.2 ±		INITIAL REVISION:				DOCUMENT NUMBER		DOC TYPE	
1 PLACE ±		±		DRWN: SKLIM01				2005/10/26		DOC PART	
0 PLACES ±		±		APPR: PTLIM				2005/11/07		REVISION	
ANGULAR TOL ± 3.0°				DRAFT WHERE APPLICABLE MUST REMAIN WITHIN DIMENSIONS		THIRD ANGLE PROJECTION		DRAWING		SERIES	
						A3-SIZE		87898		MATERIAL NUMBER	
						SEE TABLE		CUSTOMER		SHEET NUMBER	
						GENERAL MARKET				5 OF 17	

PACKAGING OPTION PART NO.						CKT SIZE	VOID POSITION	PLATING TYPE	DIMENSION			
TRAY WITHOUT CAP	TRAY WITH CAP	TUBE WITHOUT CAP	TUBE WITH CAP	TAPE & REEL WITHOUT CAP	TAPE & REEL WITH CAP				A	B	F	M
-----	-----	87898-0761	-----	-----	-----	7	----	1	17.78	15.24	11.94	8.13
-----	-----	87898-0762	-----	-----	-----	7	----	2	17.78	15.24	11.94	8.13
-----	-----	87898-0764	-----	-----	-----	7	----	4	17.78	15.24	11.94	8.13
-----	-----	87898-0765	-----	-----	-----	7	----	5	17.78	15.24	11.94	8.13
-----	-----	87898-0766	-----	-----	-----	7	----	6	17.78	15.24	11.94	8.13
-----	-----	87898-0861	-----	-----	-----	8	----	1	20.32	17.78	11.94	8.13
-----	-----	87898-0862	-----	-----	-----	8	----	2	20.32	17.78	11.94	8.13
-----	-----	87898-0864	-----	-----	-----	8	----	4	20.32	17.78	11.94	8.13
-----	-----	87898-0865	-----	-----	-----	8	----	5	20.32	17.78	11.94	8.13
-----	-----	87898-0866	-----	-----	-----	8	----	6	20.32	17.78	11.94	8.13
-----	-----	87898-0961	-----	-----	-----	9	----	1	22.86	20.32	11.94	8.13
-----	-----	87898-0962	-----	-----	-----	9	----	2	22.86	20.32	11.94	8.13
-----	-----	87898-0964	-----	-----	-----	9	----	4	22.86	20.32	11.94	8.13
-----	-----	87898-0965	-----	-----	-----	9	----	5	22.86	20.32	11.94	8.13
-----	-----	87898-0966	-----	-----	-----	9	----	6	22.86	20.32	11.94	8.13

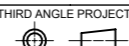
THIS DRAWING CONTAINS INFORMATION THAT IS PROPRIETARY TO MOLEX ELECTRONIC TECHNOLOGIES, LLC AND SHOULD NOT BE USED WITHOUT WRITTEN PERMISSION													
DIMENSION UNITS		SCALE		CURRENT REV DESC:									
mm		NTS											
GENERAL TOLERANCES (UNLESS SPECIFIED)				EC NO: 698212 DRWN: DANUSA 2022/03/03 CHK'D: DANUSA 2022/03/04 APPR: MRAMAKRISHNA 2022/03/04						CUSTOM HEADER 2.54MM PITCH SINGLE ROW SINGLE WAFER SMT HEADER			
4 PLACES		±	±	INITIAL REVISION: DRWN: SKLIM01 2005/10/26 APPR: PTLIM 2005/11/07						PRODUCT CUSTOMER DRAWING DOCUMENT NUMBER: SD-87898-003 DOC TYPE: PSD DOC PART: 001 REVISION: C1			
3 PLACES		±	±										
2 PLACES		±	0.2	DRAFT WHERE APPLICABLE MUST REMAIN WITHIN DIMENSIONS						THIRD ANGLE PROJECTION 			
1 PLACE		±	±										
0 PLACES		±	±	DRAWING		SERIES		MATERIAL NUMBER		CUSTOMER			
ANGULAR TOL		± 3.0°		A3-SIZE		87898		SEE TABLE		GENERAL MARKET			
DOCUMENT STATUS		P1	RELEASE DATE	2022/03/04		09:00:56		SHEET NUMBER		6 OF 17			

PACKAGING OPTION PART NO.						CKT SIZE	VOID POSITION	PLATING TYPE	DIMENSION			
TRAY WITHOUT CAP	TRAY WITH CAP	TUBE WITHOUT CAP	TUBE WITH CAP	TAPE & REEL WITHOUT CAP	TAPE & REEL WITH CAP				A	B	F	M
-----	-----	87898-1061	-----	-----	-----	10	----	1	25.40	22.86	11.94	8.13
-----	-----	87898-1062	-----	-----	-----	10	----	2	25.40	22.86	11.94	8.13
-----	-----	87898-1064	-----	-----	-----	10	----	4	25.40	22.86	11.94	8.13
-----	-----	87898-1065	-----	-----	-----	10	----	5	25.40	22.86	11.94	8.13
-----	-----	87898-1066	-----	-----	-----	10	----	6	25.40	22.86	11.94	8.13
-----	-----	87898-1161	-----	-----	-----	11	----	1	27.94	25.40	11.94	8.13
-----	-----	87898-1162	-----	-----	-----	11	----	2	27.94	25.40	11.94	8.13
-----	-----	87898-1164	-----	-----	-----	11	----	4	27.94	25.40	11.94	8.13
-----	-----	87898-1165	-----	-----	-----	11	----	5	27.94	25.40	11.94	8.13
-----	-----	87898-1166	-----	-----	-----	11	----	6	27.94	25.40	11.94	8.13
-----	-----	87898-1261	-----	-----	-----	12	----	1	30.48	27.94	11.94	8.13
-----	-----	87898-1262	-----	-----	-----	12	----	2	30.48	27.94	11.94	8.13
-----	-----	87898-1264	-----	-----	-----	12	----	4	30.48	27.94	11.94	8.13
-----	-----	87898-1265	-----	-----	-----	12	----	5	30.48	27.94	11.94	8.13
-----	-----	87898-1266	-----	-----	-----	12	----	6	30.48	27.94	11.94	8.13

THIS DRAWING CONTAINS INFORMATION THAT IS PROPRIETARY TO MOLEX ELECTRONIC TECHNOLOGIES, LLC AND SHOULD NOT BE USED WITHOUT WRITTEN PERMISSION												
DIMENSION UNITS		SCALE		CURRENT REV DESC:								
mm		NTS										
GENERAL TOLERANCES (UNLESS SPECIFIED)				EC NO: 698212 DRWN: DANUSA 2022/03/03 CHK'D: DANUSA 2022/03/04 APPR: MRAMAKRISHNA 2022/03/04				CUSTOM HEADER 2.54MM PITCH SINGLE ROW SINGLE WAFER SMT HEADER				
		MM	INCH									
4 PLACES	±		±	INITIAL REVISION: DRWN: SKLIM01 2005/10/26 APPR: PTLIM 2005/11/07				DOCUMENT NUMBER		DOC TYPE	DOC PART	REVISION
3 PLACES	±		±					SD-87898-003		PSD	001	C1
2 PLACES	±	0.2	±	DRAFT WHERE APPLICABLE MUST REMAIN WITHIN DIMENSIONS				MATERIAL NUMBER		CUSTOMER		SHEET NUMBER
1 PLACE	±		±					SEE TABLE		GENERAL MARKET		7 OF 17
0 PLACES	±		±	THIRD ANGLE PROJECTION		DRAWING	SERIES	A3-SIZE		87898		
ANGULAR TOL		± 3.0°		DRAWING		SERIES		MATERIAL NUMBER		CUSTOMER		

PACKAGING OPTION PART NO.						CKT SIZE	VOID POSITION	PLATING TYPE	DIMENSION			
TRAY WITHOUT CAP	TRAY WITH CAP	TUBE WITHOUT CAP	TUBE WITH CAP	TAPE & REEL WITHOUT CAP	TAPE & REEL WITH CAP				A	B	F	M
-----	-----	87898-1361	-----	-----	-----	13	----	1	33.02	30.48	11.94	8.13
-----	-----	87898-1362	-----	-----	-----	13	----	2	33.02	30.48	11.94	8.13
-----	-----	87898-1364	-----	-----	-----	13	----	4	33.02	30.48	11.94	8.13
-----	-----	87898-1365	-----	-----	-----	13	----	5	33.02	30.48	11.94	8.13
-----	-----	87898-1366	-----	-----	-----	13	----	6	33.02	30.48	11.94	8.13
-----	-----	87898-1461	-----	-----	-----	14	----	1	35.56	33.02	11.94	8.13
-----	-----	87898-1462	-----	-----	-----	14	----	2	35.56	33.02	11.94	8.13
-----	-----	87898-1464	-----	-----	-----	14	----	4	35.56	33.02	11.94	8.13
-----	-----	87898-1465	-----	-----	-----	14	----	5	35.56	33.02	11.94	8.13
-----	-----	87898-1466	-----	-----	-----	14	----	6	35.56	33.02	11.94	8.13
-----	-----	87898-1561	-----	-----	-----	15	----	1	38.10	35.56	11.94	8.13
-----	-----	87898-1562	-----	-----	-----	15	----	2	38.10	35.56	11.94	8.13
-----	-----	87898-1564	-----	-----	-----	15	----	4	38.10	35.56	11.94	8.13
-----	-----	87898-1565	-----	-----	-----	15	----	5	38.10	35.56	11.94	8.13
-----	-----	87898-1566	-----	-----	-----	15	----	6	38.10	35.56	11.94	8.13

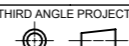
THIS DRAWING CONTAINS INFORMATION THAT IS PROPRIETARY TO MOLEX ELECTRONIC TECHNOLOGIES, LLC AND SHOULD NOT BE USED WITHOUT WRITTEN PERMISSION													
DIMENSION UNITS		SCALE		CURRENT REV DESC:									
mm		NTS											
GENERAL TOLERANCES (UNLESS SPECIFIED)				EC NO: 698212 DRWN: DANUSA 2022/03/03 CHK'D: DANUSA 2022/03/04 APPR: MRAMAKRISHNA 2022/03/04						CUSTOM HEADER 2.54MM PITCH SINGLE ROW SINGLE WAFER SMT HEADER			
		MM	INCH										
4 PLACES	±		±	INITIAL REVISION: DRWN: SKLIM01 2005/10/26 APPR: PTLIM 2005/11/07						PRODUCT CUSTOMER DRAWING DOCUMENT NUMBER: SD-87898-003 DOC TYPE: PSD DOC PART: 001 REVISION: C1			
3 PLACES	±		±										
2 PLACES	±	0.2	±	DRAFT WHERE APPLICABLE MUST REMAIN WITHIN DIMENSIONS						THIRD ANGLE PROJECTION 			
1 PLACE	±		±										
0 PLACES	±		±	DRAWING		SERIES		MATERIAL NUMBER		CUSTOMER		SHEET NUMBER	
ANGULAR TOL ± 3.0°				A3-SIZE		87898		SEE TABLE		GENERAL MARKET		8 OF 17	

PACKAGING OPTION PART NO.						CKT SIZE	VOID POSITION	PLATING TYPE	DIMENSION			
TRAY WITHOUT CAP	TRAY WITH CAP	TUBE WITHOUT CAP	TUBE WITH CAP	TAPE & REEL WITHOUT CAP	TAPE & REEL WITH CAP				A	B	F	M
-----	-----	87898-1661	-----	-----	-----	16	----	1	40.64	38.10	11.94	8.13
-----	-----	87898-1662	-----	-----	-----	16	----	2	40.64	38.10	11.94	8.13
-----	-----	87898-1664	-----	-----	-----	16	----	4	40.64	38.10	11.94	8.13
-----	-----	87898-1665	-----	-----	-----	16	----	5	40.64	38.10	11.94	8.13
-----	-----	87898-1666	-----	-----	-----	16	----	6	40.64	38.10	11.94	8.13
-----	-----	87898-1761	-----	-----	-----	17	----	1	43.18	40.64	11.94	8.13
-----	-----	87898-1762	-----	-----	-----	17	----	2	43.18	40.64	11.94	8.13
-----	-----	87898-1764	-----	-----	-----	17	----	4	43.18	40.64	11.94	8.13
-----	-----	87898-1765	-----	-----	-----	17	----	5	43.18	40.64	11.94	8.13
-----	-----	87898-1766	-----	-----	-----	17	----	6	43.18	40.64	11.94	8.13
-----	-----	87898-1861	-----	-----	-----	18	----	1	45.72	43.18	11.94	8.13
-----	-----	87898-1862	-----	-----	-----	18	----	2	45.72	43.18	11.94	8.13
-----	-----	87898-1864	-----	-----	-----	18	----	4	45.72	43.18	11.94	8.13
-----	-----	87898-1865	-----	-----	-----	18	----	5	45.72	43.18	11.94	8.13
-----	-----	87898-1866	-----	-----	-----	18	----	6	45.72	43.18	11.94	8.13

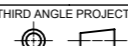
THIS DRAWING CONTAINS INFORMATION THAT IS PROPRIETARY TO MOLEX ELECTRONIC TECHNOLOGIES, LLC AND SHOULD NOT BE USED WITHOUT WRITTEN PERMISSION														
DIMENSION UNITS		SCALE		CURRENT REV DESC:										
mm		NTS												
GENERAL TOLERANCES (UNLESS SPECIFIED)				EC NO: 698212 DRWN: DANUSA 2022/03/03 CHK'D: DANUSA 2022/03/04 APPR: MRAMAKRISHNA 2022/03/04						CUSTOM HEADER 2.54MM PITCH SINGLE ROW SINGLE WAFER SMT HEADER				
		MM	INCH											
4 PLACES	±		±	INITIAL REVISION: DRWN: SKLIM01 2005/10/26 APPR: PTLIM 2005/11/07						DOCUMENT NUMBER		DOC TYPE	DOC PART	REVISION
3 PLACES	±		±							SD-87898-003		PSD	001	C1
2 PLACES	±	0.2	±	DRAFT WHERE APPLICABLE MUST REMAIN WITHIN DIMENSIONS						MATERIAL NUMBER		CUSTOMER		SHEET NUMBER
1 PLACE	±		±							SEE TABLE		GENERAL MARKET		9 OF 17
0 PLACES	±		±	THIRD ANGLE PROJECTION		DRAWING	SERIES	A3-SIZE		87898				
ANGULAR TOL ± 3.0°														

PACKAGING OPTION PART NO.						CKT SIZE	VOID POSITION	PLATING TYPE	DIMENSION			
TRAY WITHOUT CAP	TRAY WITH CAP	TUBE WITHOUT CAP	TUBE WITH CAP	TAPE & REEL WITHOUT CAP	TAPE & REEL WITH CAP				A	B	F	M
-----	-----	87898-1961	-----	-----	-----	19	----	1	48.26	45.72	11.94	8.13
-----	-----	87898-1962	-----	-----	-----	19	----	2	48.26	45.72	11.94	8.13
-----	-----	87898-1964	-----	-----	-----	19	----	4	48.26	45.72	11.94	8.13
-----	-----	87898-1965	-----	-----	-----	19	----	5	48.26	45.72	11.94	8.13
-----	-----	87898-1966	-----	-----	-----	19	----	6	48.26	45.72	11.94	8.13
-----	-----	87898-2061	-----	-----	-----	20	----	1	50.80	48.26	11.94	8.13
-----	-----	87898-2062	-----	-----	-----	20	----	2	50.80	48.26	11.94	8.13
-----	-----	87898-2064	-----	-----	-----	20	----	4	50.80	48.26	11.94	8.13
-----	-----	87898-2065	-----	-----	-----	20	----	5	50.80	48.26	11.94	8.13
-----	-----	87898-2066	-----	-----	-----	20	----	6	50.80	48.26	11.94	8.13
-----	-----	87898-2161	-----	-----	-----	21	----	1	53.34	50.80	11.94	8.13
-----	-----	87898-2162	-----	-----	-----	21	----	2	53.34	50.80	11.94	8.13
-----	-----	87898-2164	-----	-----	-----	21	----	4	53.34	50.80	11.94	8.13
-----	-----	87898-2165	-----	-----	-----	21	----	5	53.34	50.80	11.94	8.13
-----	-----	87898-2166	-----	-----	-----	21	----	6	53.34	50.80	11.94	8.13

THIS DRAWING CONTAINS INFORMATION THAT IS PROPRIETARY TO MOLEX ELECTRONIC TECHNOLOGIES, LLC AND SHOULD NOT BE USED WITHOUT WRITTEN PERMISSION											
DIMENSION UNITS		SCALE		CURRENT REV DESC:							
mm		NTS		EC NO: 698212							
GENERAL TOLERANCES (UNLESS SPECIFIED)				DRWN: DANUSA		2022/03/03		CUSTOM HEADER 2.54MM PITCH SINGLE ROW SINGLE WAFER SMT HEADER			
				CHK'D: DANUSA		2022/03/04					
				APPR: MRAMAKRISHNA		2022/03/04		PRODUCT CUSTOMER DRAWING			
				INITIAL REVISION:				DOCUMENT NUMBER		DOC TYPE	
				DRWN: SKLIM01		2005/10/26		SD-87898-003		PSD	
				APPR: PTLIM		2005/11/07		001		C1	
ANGULAR TOL ± 3.0°				DRAFT WHERE APPLICABLE MUST REMAIN WITHIN DIMENSIONS		THIRD ANGLE PROJECTION		DRAWING		SHEET NUMBER	
						A3-SIZE		87898		10 OF 17	

PACKAGING OPTION PART NO.						CKT SIZE	VOID POSITION	PLATING TYPE	DIMENSION			
TRAY WITHOUT CAP	TRAY WITH CAP	TUBE WITHOUT CAP	TUBE WITH CAP	TAPE & REEL WITHOUT CAP	TAPE & REEL WITH CAP				A	B	F	M
-----	-----	87898-2261	-----	-----	-----	22	----	1	55.88	53.34	11.94	8.13
-----	-----	87898-2262	-----	-----	-----	22	----	2	55.88	53.34	11.94	8.13
-----	-----	87898-2264	-----	-----	-----	22	----	4	55.88	53.34	11.94	8.13
-----	-----	87898-2265	-----	-----	-----	22	----	5	55.88	53.34	11.94	8.13
-----	-----	87898-2266	-----	-----	-----	22	----	6	55.88	53.34	11.94	8.13
-----	-----	87898-2361	-----	-----	-----	23	----	1	58.42	55.88	11.94	8.13
-----	-----	87898-2362	-----	-----	-----	23	----	2	58.42	55.88	11.94	8.13
-----	-----	87898-2364	-----	-----	-----	23	----	4	58.42	55.88	11.94	8.13
-----	-----	87898-2365	-----	-----	-----	23	----	5	58.42	55.88	11.94	8.13
-----	-----	87898-2366	-----	-----	-----	23	----	6	58.42	55.88	11.94	8.13
-----	-----	87898-2461	-----	-----	-----	24	----	1	60.96	58.42	11.94	8.13
-----	-----	87898-2462	-----	-----	-----	24	----	2	60.96	58.42	11.94	8.13
-----	-----	87898-2464	-----	-----	-----	24	----	4	60.96	58.42	11.94	8.13
-----	-----	87898-2465	-----	-----	-----	24	----	5	60.96	58.42	11.94	8.13
-----	-----	87898-2466	-----	-----	-----	24	----	6	60.96	58.42	11.94	8.13

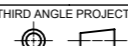
THIS DRAWING CONTAINS INFORMATION THAT IS PROPRIETARY TO MOLEX ELECTRONIC TECHNOLOGIES, LLC AND SHOULD NOT BE USED WITHOUT WRITTEN PERMISSION												
DIMENSION UNITS		SCALE		CURRENT REV DESC:								
mm		NTS										
GENERAL TOLERANCES (UNLESS SPECIFIED)				EC NO: 698212 DRWN: DANUSA 2022/03/03 CHK'D: DANUSA 2022/03/04 APPR: MRAMAKRISHNA 2022/03/04				CUSTOM HEADER 2.54MM PITCH SINGLE ROW SINGLE WAFER SMT HEADER				
		MM	INCH									
4 PLACES	±		±	INITIAL REVISION: DRWN: SKLIM01 2005/10/26 APPR: PTLIM 2005/11/07				DOCUMENT NUMBER		DOC TYPE	DOC PART	REVISION
3 PLACES	±		±					SD-87898-003		PSD	001	C1
2 PLACES	±	0.2	±	DRAFT WHERE APPLICABLE MUST REMAIN WITHIN DIMENSIONS				MATERIAL NUMBER		CUSTOMER		SHEET NUMBER
1 PLACE	±		±					SEE TABLE		GENERAL MARKET		11 OF 17
0 PLACES	±		±	THIRD ANGLE PROJECTION		DRAWING	SERIES	CUSTOMER		SHEET NUMBER		
ANGULAR TOL ± 3.0°				A3-SIZE	87898	SEE TABLE		GENERAL MARKET		11 OF 17		

PACKAGING OPTION PART NO.						CKT SIZE	VOID POSITION	PLATING TYPE	DIMENSION			
TRAY WITHOUT CAP	TRAY WITH CAP	TUBE WITHOUT CAP	TUBE WITH CAP	TAPE & REEL WITHOUT CAP	TAPE & REEL WITH CAP				A	B	F	M
-----	-----	87898-2561	-----	-----	-----	25	----	1	63.50	60.96	11.94	8.13
-----	-----	87898-2562	-----	-----	-----	25	----	2	63.50	60.96	11.94	8.13
-----	-----	87898-2564	-----	-----	-----	25	----	4	63.50	60.96	11.94	8.13
-----	-----	87898-2565	-----	-----	-----	25	----	5	63.50	60.96	11.94	8.13
-----	-----	87898-2566	-----	-----	-----	25	----	6	63.50	60.96	11.94	8.13
-----	-----	87898-2661	-----	-----	-----	26	----	1	66.04	63.50	11.94	8.13
-----	-----	87898-2662	-----	-----	-----	26	----	2	66.04	63.50	11.94	8.13
-----	-----	87898-2664	-----	-----	-----	26	----	4	66.04	63.50	11.94	8.13
-----	-----	87898-2665	-----	-----	-----	26	----	5	66.04	63.50	11.94	8.13
-----	-----	87898-2666	-----	-----	-----	26	----	6	66.04	63.50	11.94	8.13
-----	-----	87898-2761	-----	-----	-----	27	----	1	68.58	66.04	11.94	8.13
-----	-----	87898-2762	-----	-----	-----	27	----	2	68.58	66.04	11.94	8.13
-----	-----	87898-2764	-----	-----	-----	27	----	4	68.58	66.04	11.94	8.13
-----	-----	87898-2765	-----	-----	-----	27	----	5	68.58	66.04	11.94	8.13
-----	-----	87898-2766	-----	-----	-----	27	----	6	68.58	66.04	11.94	8.13

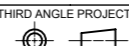
THIS DRAWING CONTAINS INFORMATION THAT IS PROPRIETARY TO MOLEX ELECTRONIC TECHNOLOGIES, LLC AND SHOULD NOT BE USED WITHOUT WRITTEN PERMISSION												
DIMENSION UNITS		SCALE		CURRENT REV DESC:								
mm		NTS										
GENERAL TOLERANCES (UNLESS SPECIFIED)				EC NO: 698212 DRWN: DANUSA 2022/03/03 CHK'D: DANUSA 2022/03/04 APPR: MRAMAKRISHNA 2022/03/04				CUSTOM HEADER 2.54MM PITCH SINGLE ROW SINGLE WAFER SMT HEADER				
		MM	INCH									
4 PLACES	±		±	INITIAL REVISION: DRWN: SKLIM01 2005/10/26 APPR: PTLIM 2005/11/07				DOCUMENT NUMBER		DOC TYPE	DOC PART	REVISION
3 PLACES	±		±					SD-87898-003		PSD	001	C1
2 PLACES	±	0.2	±	DRAFT WHERE APPLICABLE MUST REMAIN WITHIN DIMENSIONS				MATERIAL NUMBER		CUSTOMER		SHEET NUMBER
1 PLACE	±		±					SEE TABLE		GENERAL MARKET		12 OF 17
0 PLACES	±		±	THIRD ANGLE PROJECTION		DRAWING	SERIES	CUSTOMER		SHEET NUMBER		
ANGULAR TOL		± 3.0°				A3-SIZE	87898	GENERAL MARKET		12 OF 17		

PACKAGING OPTION PART NO.						CKT SIZE	VOID POSITION	PLATING TYPE	DIMENSION			
TRAY WITHOUT CAP	TRAY WITH CAP	TUBE WITHOUT CAP	TUBE WITH CAP	TAPE & REEL WITHOUT CAP	TAPE & REEL WITH CAP				A	B	F	M
-----	-----	87898-2861	-----	-----	-----	28	----	1	71.12	68.58	11.94	8.13
-----	-----	87898-2862	-----	-----	-----	28	----	2	71.12	68.58	11.94	8.13
-----	-----	87898-2864	-----	-----	-----	28	----	4	71.12	68.58	11.94	8.13
-----	-----	87898-2865	-----	-----	-----	28	----	5	71.12	68.58	11.94	8.13
-----	-----	87898-2866	-----	-----	-----	28	----	6	71.12	68.58	11.94	8.13
-----	-----	87898-2961	-----	-----	-----	29	----	1	73.66	71.12	11.94	8.13
-----	-----	87898-2962	-----	-----	-----	29	----	2	73.66	71.12	11.94	8.13
-----	-----	87898-2964	-----	-----	-----	29	----	4	73.66	71.12	11.94	8.13
-----	-----	87898-2965	-----	-----	-----	29	----	5	73.66	71.12	11.94	8.13
-----	-----	87898-2966	-----	-----	-----	29	----	6	73.66	71.12	11.94	8.13
-----	-----	87898-3061	-----	-----	-----	30	----	1	76.20	73.66	11.94	8.13
-----	-----	87898-3062	-----	-----	-----	30	----	2	76.20	73.66	11.94	8.13
-----	-----	87898-3064	-----	-----	-----	30	----	4	76.20	73.66	11.94	8.13
-----	-----	87898-3065	-----	-----	-----	30	----	5	76.20	73.66	11.94	8.13
-----	-----	87898-3066	-----	-----	-----	30	----	6	76.20	73.66	11.94	8.13

THIS DRAWING CONTAINS INFORMATION THAT IS PROPRIETARY TO MOLEX ELECTRONIC TECHNOLOGIES, LLC AND SHOULD NOT BE USED WITHOUT WRITTEN PERMISSION

DIMENSION UNITS	SCALE	CURRENT REV DESC:		molex
mm	NTS			
GENERAL TOLERANCES (UNLESS SPECIFIED)		EC NO: 698212		CUSTOM HEADER 2.54MM PITCH SINGLE ROW SINGLE WAFER SMT HEADER
4 PLACES	±	DRWN: DANUSA	2022/03/03	
3 PLACES	±	CHK'D: DANUSA	2022/03/04	
2 PLACES	± 0.2	APPR: MRAMAKRISHNA	2022/03/04	
1 PLACE	±	INITIAL REVISION:		
0 PLACES	±	DRWN: SKLIM01	2005/10/26	
ANGULAR TOL	± 3.0°	APPR: PTLIM	2005/11/07	
DRAFT WHERE APPLICABLE MUST REMAIN WITHIN DIMENSIONS		THIRD ANGLE PROJECTION	DRAWING	SERIES
			A3-SIZE	87898
DOCUMENT STATUS		DOCUMENT NUMBER	CUSTOMER	SHEET NUMBER
P1	RELEASE DATE	SD-87898-003	GENERAL MARKET	13 OF 17
2022/03/04	09:00:56	PSD		
		001		
		C1		

PACKAGING OPTION PART NO.						CKT SIZE	VOID POSITION	PLATING TYPE	DIMENSION			
TRAY WITHOUT CAP	TRAY WITH CAP	TUBE WITHOUT CAP	TUBE WITH CAP	TAPE & REEL WITHOUT CAP	TAPE & REEL WITH CAP				A	B	F	M
-----	-----	87898-3161	-----	-----	-----	31	----	1	78.74	76.20	11.94	8.13
-----	-----	87898-3162	-----	-----	-----	31	----	2	78.74	76.20	11.94	8.13
-----	-----	87898-3164	-----	-----	-----	31	----	4	78.74	76.20	11.94	8.13
-----	-----	87898-3165	-----	-----	-----	31	----	5	78.74	76.20	11.94	8.13
-----	-----	87898-3166	-----	-----	-----	31	----	6	78.74	76.20	11.94	8.13
-----	-----	87898-3261	-----	-----	-----	32	----	1	81.28	78.74	11.94	8.13
-----	-----	87898-3262	-----	-----	-----	32	----	2	81.28	78.74	11.94	8.13
-----	-----	87898-3264	-----	-----	-----	32	----	4	81.28	78.74	11.94	8.13
-----	-----	87898-3265	-----	-----	-----	32	----	5	81.28	78.74	11.94	8.13
-----	-----	87898-3266	-----	-----	-----	32	----	6	81.28	78.74	11.94	8.13
-----	-----	87898-3361	-----	-----	-----	33	----	1	83.82	81.28	11.94	8.13
-----	-----	87898-3362	-----	-----	-----	33	----	2	83.82	81.28	11.94	8.13
-----	-----	87898-3364	-----	-----	-----	33	----	4	83.82	81.28	11.94	8.13
-----	-----	87898-3365	-----	-----	-----	33	----	5	83.82	81.28	11.94	8.13
-----	-----	87898-3366	-----	-----	-----	33	----	6	83.82	81.28	11.94	8.13

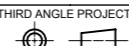
THIS DRAWING CONTAINS INFORMATION THAT IS PROPRIETARY TO MOLEX ELECTRONIC TECHNOLOGIES, LLC AND SHOULD NOT BE USED WITHOUT WRITTEN PERMISSION															
DIMENSION UNITS		SCALE		CURRENT REV DESC:											
mm		NTS													
GENERAL TOLERANCES (UNLESS SPECIFIED)				EC NO: 698212 DRWN: DANUSA 2022/03/03 CHK'D: DANUSA 2022/03/04 APPR: MRAMAKRISHNA 2022/03/04						CUSTOM HEADER 2.54MM PITCH SINGLE ROW SINGLE WAFER SMT HEADER					
		MM	INCH												
4 PLACES	±		±	INITIAL REVISION: DRWN: SKLIM01 2005/10/26 APPR: PTLIM 2005/11/07						DOCUMENT NUMBER SD-87898-003		DOC TYPE PSD	DOC PART 001	REVISION C1	
3 PLACES	±		±												
2 PLACES	±	0.2	±	DRAFT WHERE APPLICABLE MUST REMAIN WITHIN DIMENSIONS						MATERIAL NUMBER SEE TABLE		CUSTOMER GENERAL MARKET		SHEET NUMBER 14 OF 17	
1 PLACE	±		±												
0 PLACES	±		±	THIRD ANGLE PROJECTION		DRAWING		SERIES		MATERIAL NUMBER		CUSTOMER		SHEET NUMBER	
ANGULAR TOL ± 3.0°						A3-SIZE		87898		SEE TABLE		GENERAL MARKET		14 OF 17	

PACKAGING OPTION PART NO.						CKT SIZE	VOID POSITION	PLATING TYPE	DIMENSION			
TRAY WITHOUT CAP	TRAY WITH CAP	TUBE WITHOUT CAP	TUBE WITH CAP	TAPE & REEL WITHOUT CAP	TAPE & REEL WITH CAP				A	B	F	M
-----	-----	87898-3461	-----	-----	-----	34	----	1	86.36	83.82	11.94	8.13
-----	-----	87898-3462	-----	-----	-----	34	----	2	86.36	83.82	11.94	8.13
-----	-----	87898-3464	-----	-----	-----	34	----	4	86.36	83.82	11.94	8.13
-----	-----	87898-3465	-----	-----	-----	34	----	5	86.36	83.82	11.94	8.13
-----	-----	87898-3466	-----	-----	-----	34	----	6	86.36	83.82	11.94	8.13
-----	-----	87898-3561	-----	-----	-----	35	----	1	88.90	86.36	11.94	8.13
-----	-----	87898-3562	-----	-----	-----	35	----	2	88.90	86.36	11.94	8.13
-----	-----	87898-3564	-----	-----	-----	35	----	4	88.90	86.36	11.94	8.13
-----	-----	87898-3565	-----	-----	-----	35	----	5	88.90	86.36	11.94	8.13
-----	-----	87898-3566	-----	-----	-----	35	----	6	88.90	86.36	11.94	8.13
-----	-----	87898-3661	-----	-----	-----	36	----	1	91.44	88.90	11.94	8.13
-----	-----	87898-3662	-----	-----	-----	36	----	2	91.44	88.90	11.94	8.13
-----	-----	87898-3664	-----	-----	-----	36	----	4	91.44	88.90	11.94	8.13
-----	-----	87898-3665	-----	-----	-----	36	----	5	91.44	88.90	11.94	8.13
-----	-----	87898-3666	-----	-----	-----	36	----	6	91.44	88.90	11.94	8.13

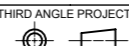
THIS DRAWING CONTAINS INFORMATION THAT IS PROPRIETARY TO MOLEX ELECTRONIC TECHNOLOGIES, LLC AND SHOULD NOT BE USED WITHOUT WRITTEN PERMISSION												
DIMENSION UNITS		SCALE		CURRENT REV DESC:								
mm		NTS										
GENERAL TOLERANCES (UNLESS SPECIFIED)				EC NO: 698212 DRWN: DANUSA 2022/03/03 CHK'D: DANUSA 2022/03/04 APPR: MRAMAKRISHNA 2022/03/04				CUSTOM HEADER 2.54MM PITCH SINGLE ROW SINGLE WAFER SMT HEADER				
		MM	INCH									
4 PLACES	±		±	INITIAL REVISION: DRWN: SKLIM01 2005/10/26 APPR: PTLIM 2005/11/07				DOCUMENT NUMBER		DOC TYPE	DOC PART	REVISION
3 PLACES	±		±					SD-87898-003		PSD	001	C1
2 PLACES	±	0.2	±	DRAFT WHERE APPLICABLE MUST REMAIN WITHIN DIMENSIONS				MATERIAL NUMBER		CUSTOMER		SHEET NUMBER
1 PLACE	±		±					SEE TABLE		GENERAL MARKET		15 OF 17
0 PLACES	±		±	THIRD ANGLE PROJECTION		DRAWING	SERIES	CUSTOMER		SHEET NUMBER		
ANGULAR TOL		± 3.0°				A3-SIZE	87898	GENERAL MARKET		15 OF 17		

PACKAGING OPTION PART NO.						CKT SIZE	VOID POSITION	PLATING TYPE	DIMENSION			
TRAY WITHOUT CAP	TRAY WITH CAP	TUBE WITHOUT CAP	TUBE WITH CAP	TAPE & REEL WITHOUT CAP	TAPE & REEL WITH CAP				A	B	F	M
-----	-----	87898-3761	-----	-----	-----	37	----	1	93.98	91.44	11.94	8.13
-----	-----	87898-3762	-----	-----	-----	37	----	2	93.98	91.44	11.94	8.13
-----	-----	87898-3764	-----	-----	-----	37	----	4	93.98	91.44	11.94	8.13
-----	-----	87898-3765	-----	-----	-----	37	----	5	93.98	91.44	11.94	8.13
-----	-----	87898-3766	-----	-----	-----	37	----	6	93.98	91.44	11.94	8.13
-----	-----	87898-3861	-----	-----	-----	38	----	1	96.52	93.98	11.94	8.13
-----	-----	87898-3862	-----	-----	-----	38	----	2	96.52	93.98	11.94	8.13
-----	-----	87898-3864	-----	-----	-----	38	----	4	96.52	93.98	11.94	8.13
-----	-----	87898-3865	-----	-----	-----	38	----	5	96.52	93.98	11.94	8.13
-----	-----	87898-3866	-----	-----	-----	38	----	6	96.52	93.98	11.94	8.13
-----	-----	87898-3961	-----	-----	-----	39	----	1	99.06	96.52	11.94	8.13
-----	-----	87898-3962	-----	-----	-----	39	----	2	99.06	96.52	11.94	8.13
-----	-----	87898-3964	-----	-----	-----	39	----	4	99.06	96.52	11.94	8.13
-----	-----	87898-3965	-----	-----	-----	39	----	5	99.06	96.52	11.94	8.13
-----	-----	87898-3966	-----	-----	-----	39	----	6	99.06	96.52	11.94	8.13

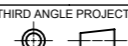
THIS DRAWING CONTAINS INFORMATION THAT IS PROPRIETARY TO MOLEX ELECTRONIC TECHNOLOGIES, LLC AND SHOULD NOT BE USED WITHOUT WRITTEN PERMISSION												
DIMENSION UNITS		SCALE		CURRENT REV DESC:								
mm		NTS		EC NO: 698212								
GENERAL TOLERANCES (UNLESS SPECIFIED)				DRWN: DANUSA		2022/03/03		CUSTOM HEADER				
				CHK'D: DANUSA		2022/03/04		2.54MM PITCH SINGLE ROW SINGLE WAFER SMT HEADER				
				APPR: MRAMAKRISHNA		2022/03/04		PRODUCT CUSTOMER DRAWING				
				INITIAL REVISION:				DOCUMENT NUMBER		DOC TYPE	DOC PART	REVISION
				DRWN: SKLIM01		2005/10/26		SD-87898-003		PSD	001	C1
				APPR: PTLIM		2005/11/07		MATERIAL NUMBER		CUSTOMER		SHEET NUMBER
DRAFT WHERE APPLICABLE MUST REMAIN WITHIN DIMENSIONS				THIRD ANGLE PROJECTION		DRAWING		SERIES		GENERAL MARKET		16 OF 17
						A3-SIZE		87898				

PACKAGING OPTION PART NO.						CKT SIZE	VOID POSITION	PLATING TYPE	DIMENSION			
TRAY WITHOUT CAP	TRAY WITH CAP	TUBE WITHOUT CAP	TUBE WITH CAP	TAPE & REEL WITHOUT CAP	TAPE & REEL WITH CAP				A	B	F	M
-----	-----	87898-4061	-----	-----	-----	40	----	1	101.6	99.06	11.94	8.13
-----	-----	87898-4062	-----	-----	-----	40	----	2	101.6	99.06	11.94	8.13
-----	-----	87898-4064	-----	-----	-----	40	----	4	101.6	99.06	11.94	8.13
-----	-----	87898-4065	-----	-----	-----	40	----	5	101.6	99.06	11.94	8.13
-----	-----	87898-4066	-----	-----	-----	40	----	6	101.6	99.06	11.94	8.13

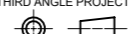
THIS DRAWING CONTAINS INFORMATION THAT IS PROPRIETARY TO MOLEX ELECTRONIC TECHNOLOGIES, LLC AND SHOULD NOT BE USED WITHOUT WRITTEN PERMISSION											
DIMENSION UNITS		SCALE		CURRENT REV DESC:							
mm		NTS									
GENERAL TOLERANCES (UNLESS SPECIFIED)				EC NO: 698212		DRWN: DANUSA		2022/03/03		CUSTOM HEADER 2.54MM PITCH SINGLE ROW SINGLE WAFER SMT HEADER	
				CHK'D: DANUSA		2022/03/04					
				APPR: MRAMAKRISHNA		2022/03/04		PRODUCT CUSTOMER DRAWING			
				INITIAL REVISION:		DRWN: SKLIM01		2005/10/26		DOCUMENT NUMBER	
				APPR: PTLIM		2005/11/07		SD-87898-003		DOC TYPE DOC PART REVISION	
				ANGULAR TOL ± 3.0°						PSD 001 C1	
DRAFT WHERE APPLICABLE MUST REMAIN WITHIN DIMENSIONS				THIRD ANGLE PROJECTION		DRAWING		SERIES		MATERIAL NUMBER	
						A3-SIZE		87898		CUSTOMER	
								SEE TABLE		GENERAL MARKET	
										SHEET NUMBER	
										17 OF 17	