

SC-20S

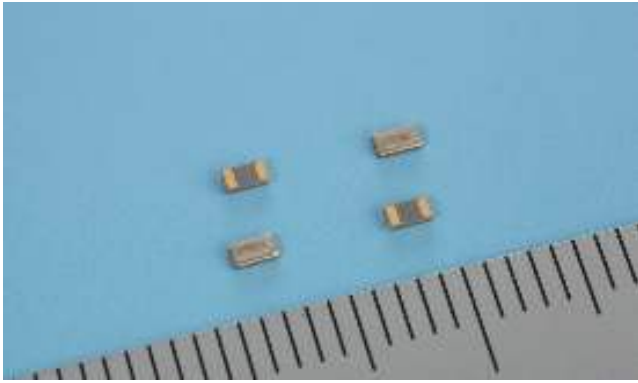

Features

- Thin type (0.6mm)
- Suitable for high density surface mounting
- Excellent shock and heat resistance
- Complete Pb-free
- Complies with EU RoHS directive
- A crystal resonator processed by high reliable photolithographic technology inside

Applications

Mobile Phone, Wearable, Module, Sub-clock function for a variety of Micro-computer etc.

(Temperature: 25±2°C, DL;0.1μW)

Standard Specifications

Item	Symbol	Specifications	Conditions Note
Nominal Frequency	f_nom	32.768kHz	
Frequency Tolerance	f_tol	±20×10 ⁻⁶	Please specify
Turnover Temperature	Ti	+25±5°C	
Parabolic Coefficient	B	(-0.030±10%)×10 ⁻⁶ /°C ²	
Load Capacitance	CL	6pF~12.5pF	
Motional Resistance (ESR)	R1	70kΩ max.	
Absolute Max. Drive Level	DLmax.	1.0μW max.	
Drive Level	DL	0.1μW typ.	
Shunt Capacitance	C0	1.3pF typ.	
Frequency Ageing	f_age	±3×10 ⁻⁶	+25±3°C, First Year
Operating Temperature	T_use	-40~+85°C	
Storage Temperature	T_stg	-55~+125°C	Piece part basis

Dimensions

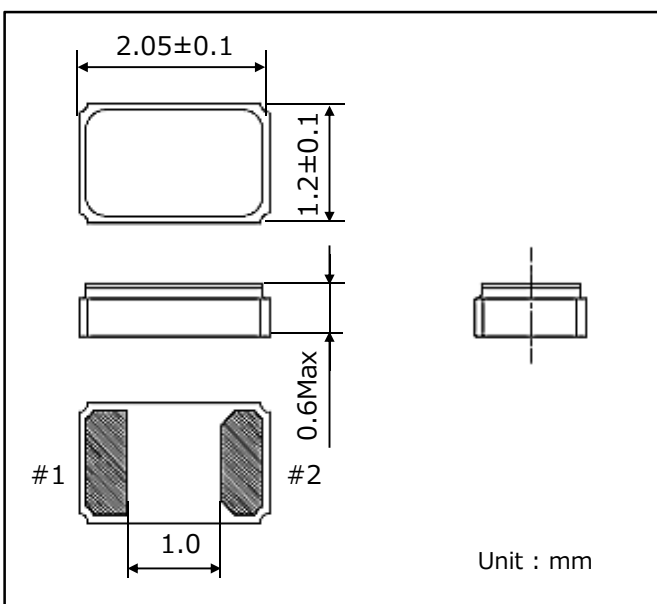

Internal Lead Connections

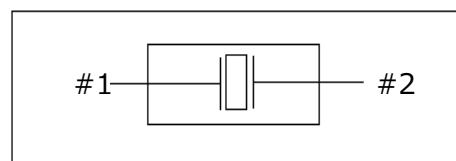

Recommended Soldering Pattern

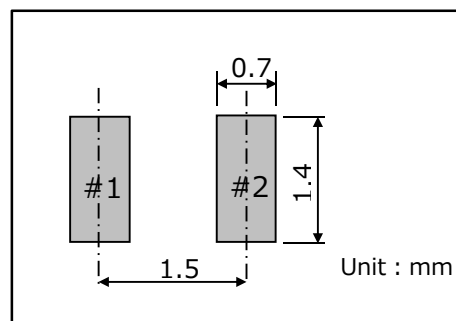

Remark: Please make sure that there is no pattern under SC-20S on the circuit board.

Seiko Instruments Inc.

Quartz Crystal Sales Department
 1-8, Nakase, Mihamaku, Chiba-shi, Chiba 261-8507, Japan
 Tel : +81-43-211-1207 Fax : +81-43-211-8030
[http : //www.sii.co.jp/en/quartz/](http://www.sii.co.jp/en/quartz/)