

Specification for AB-3838EJ Series

AB-3838EJ-F4E

3838 EMC 1.0W 940nm 3V IR LED

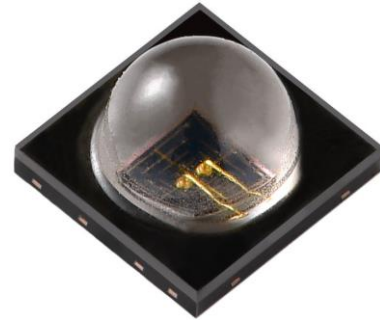

Features:

- Top view infrared LED
- High power infrared LED
- Low thermal resistance
- Pb-free reflow soldering application
- RoHS and REACH compliant

Applications:

- Infrared illumination for cameras
- Surveillance systems
- Proximity sensor
- Auto Focus
- Gaming Notebook
- Large Size Touch Panel
- Machine Vision
- Car Sensors
- Virtual Reality



AMERICAN BRIGHT OPTOELECTRONICS CORP.

Absolute Maximum Ratings ($T_j=25^{\circ}\text{C}$)

Item	Symbol	Absolute Max. Rating	Unit
Forward Current	I_F	1000	mA
Pulse Forward Current	I_{FP}	3000	mA
Power Dissipation	PD	3.6	W
Reverse Voltage	V_R	5	V
Operating Temperature	T_{opr}	-40~ +105	$^{\circ}\text{C}$
Storage Temperature	T_{stg}	-40~ +105	$^{\circ}\text{C}$
Junction Temperature	T_j	115	$^{\circ}\text{C}$
Soldering Temperature	T_{sld}	Reflow soldering: 230 $^{\circ}\text{C}$ or 260 $^{\circ}\text{C}$ for 10 sec	

* IFP condition with Pulse: Width \leq 100 μs , Duty cycle \leq 1/10

* LED's properties might be different from suggested values like above and below tables if operation condition will be exceeded our parameter range. Care is to be taken that power dissipation does not exceed the absolute maximum rating of the product

* All measurements were made under the standardized environment of American Bright LED

Electrical/Optical Characteristics ($T_j=25^{\circ}\text{C}$)

Item	Symbol	Min.	Typ.	Max.	Unit	Condition
Forward Voltage	V_F	2.6	3.0	3.4	V	$I_f = 350\text{mA}$
Reverse Current	I_R	-	-	10	μA	$V_R = 5\text{V}$
Radiant Flux	Φ_e	-	470	-	mW	$I_f = 350\text{mA}$
Viewing Angle	$2\theta_{1/2}$	-	90	-	$^{\circ}$	$I_f = 350\text{mA}$
Thermal Resistance	$R_{th\ j-sp}$	-	4.5	-	$^{\circ}\text{C}/\text{W}$	$I_f = 350\text{mA}$
Electrostatic Discharge	ESD	6000	-	-	V	HBM

* Tolerance of measurements of the Forward Voltage is $\pm 0.1\text{V}$

* Tolerance of measurements of the Radiant Flux is $\pm 7\%$

* $2\theta_{1/2}$ is the off-axis where the luminous intensity is 1/2 of the peak intensity

* Tolerance of measurements of Peak Wavelength is $\pm 2.0\text{nm}$

* $R_{th\ j-sp}$ is the thermal resistance from LED junction to solder point on MCPCB with electrical power

Naming System:

AB-3838EJ-F4E-yyy

yyy: bin code



AMERICAN BRIGHT OPTOELECTRONICS CORP.

BIN Structure

Radiant Flux BINs ($I_F = 350\text{mA}$, $T_j = 25^\circ\text{C}$)

Radiant Flux			
BIN code	Min.	Max.	Unit
JP1	390	440	mW
JP2	440	490	mW
JQ1	490	550	mW
JQ2	550	610	mW
JR1	610	690	mW

* Tolerance of measurements of the Radiant Flux is $\pm 7\%$

Peak Wavelength Bins ($I_F = 350\text{mA}$, $T_j = 25^\circ\text{C}$)

BIN code	Min.	Max.	Unit
XJ0	920	940	nm
XK0	940	960	nm

* Tolerance of measurements of the peak wavelength is $\pm 2.0\text{nm}$

Forward Voltage Ranks ($I_F = 350\text{mA}$, $T_j = 25^\circ\text{C}$)

BIN Code	Min.	Max.	Unit
AB6	2.6	2.8	V
AC3	2.8	3.0	V
AC4	3.0	3.2	V
AC5	3.2	3.4	V

* Tolerance of measurements of the Forward Voltage is $\pm 0.1\text{V}$

LED AMERICAN BRIGHT OPTOELECTRONICS CORP.

Typical Characteristics Curves

Fig 1. Typical Spectrum, $T_j = 25^\circ\text{C}$

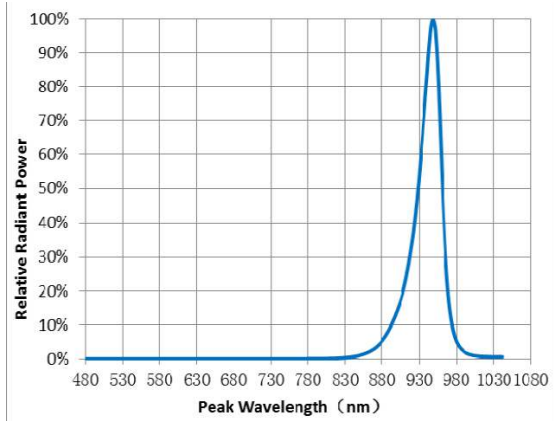

Fig 2. Forward Current vs. Relative Intensity, $T_j = 25^\circ\text{C}$

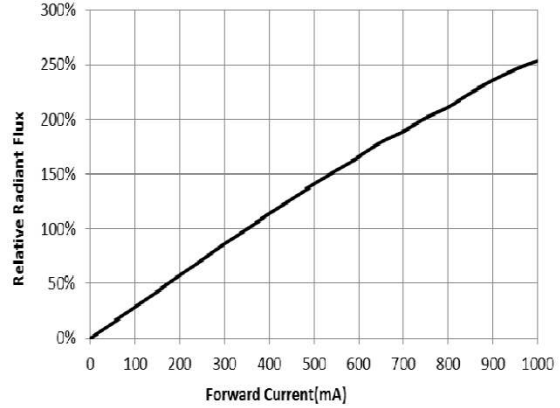

Fig 3. Forward Current vs. Relative Voltage, $T_j = 25^\circ\text{C}$

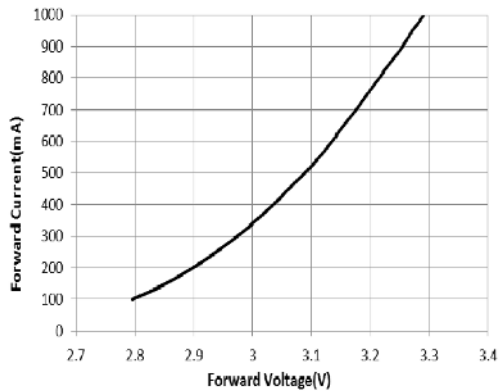

Fig 4. Soldering Temperature vs. Relative Output Flux

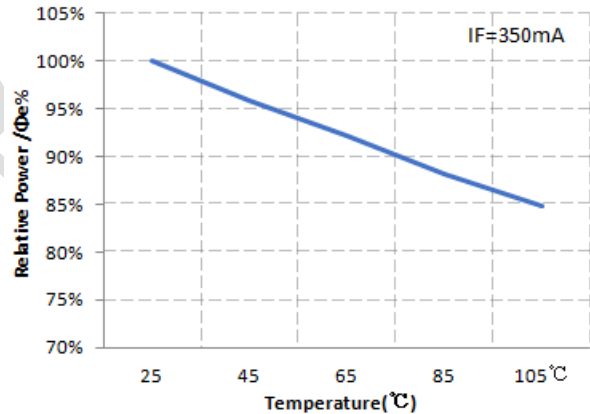

Fig 5. Typical Viewing Angle = 90° , $T_j = 25^\circ\text{C}$

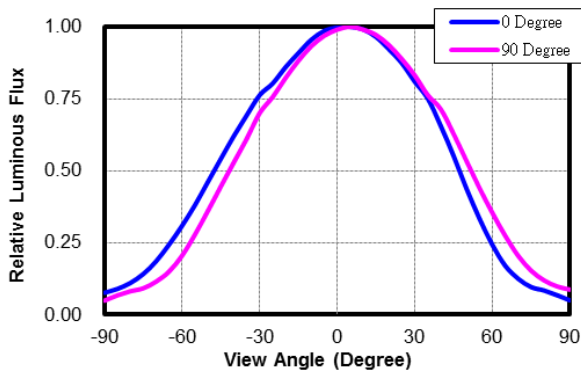
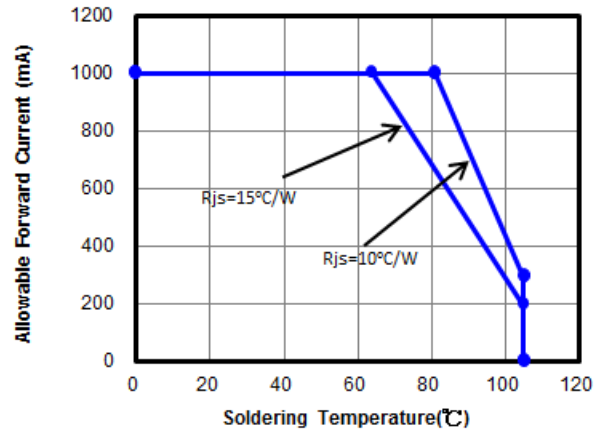
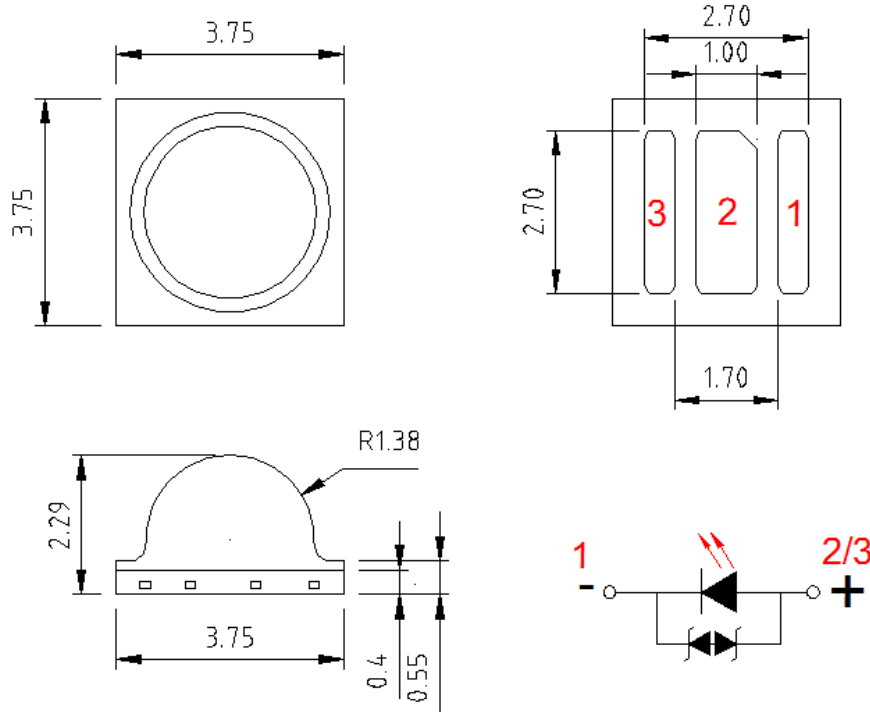

Fig 6. Soldering Temperature vs. Maximum Allowable Forward Current



Package Dimensions



* The tolerance unless mentioned is $\pm 0.2\text{mm}$, unit = mm

Recommended Solder Pad

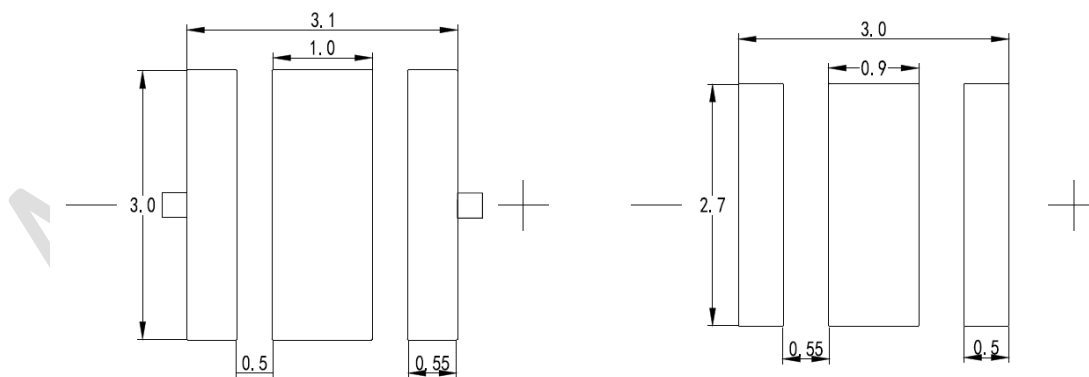

Recommended PCB Solder Pad

Recommended Stencil Pattern

* The tolerance unless mentioned is $\pm 0.1\text{mm}$, unit = mm



AMERICAN BRIGHT OPTOELECTRONICS CORP.

Reflow Soldering Characteristics

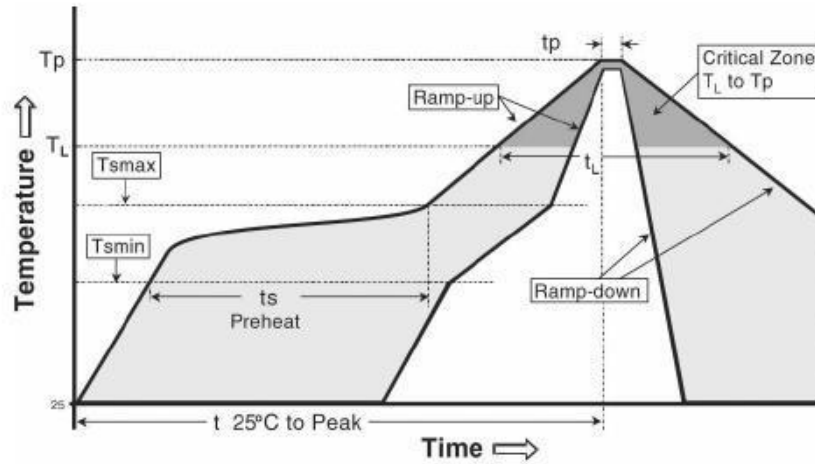

Reflow Soldering	
Temperature min ($T_{s, \min}$)	150°C
Temperature Max ($T_{s, \max}$)	200°C
Time (t_s) from ($T_{s, \min}$ to $T_{s, \max}$)	60-120 s
Ramp-up rate (T_L to T_p)	3°C/s Max
Liquidous temperature (T_L)	217°C
Time (T_L) maintained above T_L	60-150 s
Peak package body temperature	260°C Max
Time (T_p) within 5°C of the specified classification temperature (T_c)	30 s Max
Ramp-down rate (T_p to T_L)	6°C/s Max
Time 25°C to peak temperature	8 min. Max

Package Dimensions of Tape

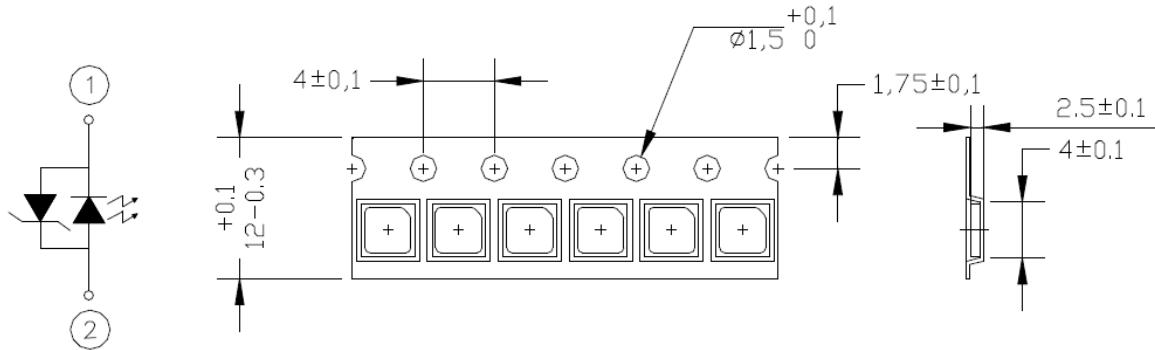

- * Quantity: Max 1000pcs/Reel
- * Cumulative Tolerance: Cumulative Tolerance/10 pitches to be ± 0.25 mm
- * Package: P/N, Manufacturing data Code No. and Quantity to be indicated on a waterproof Package.
- * unit = mm

Package Dimensions of Reel

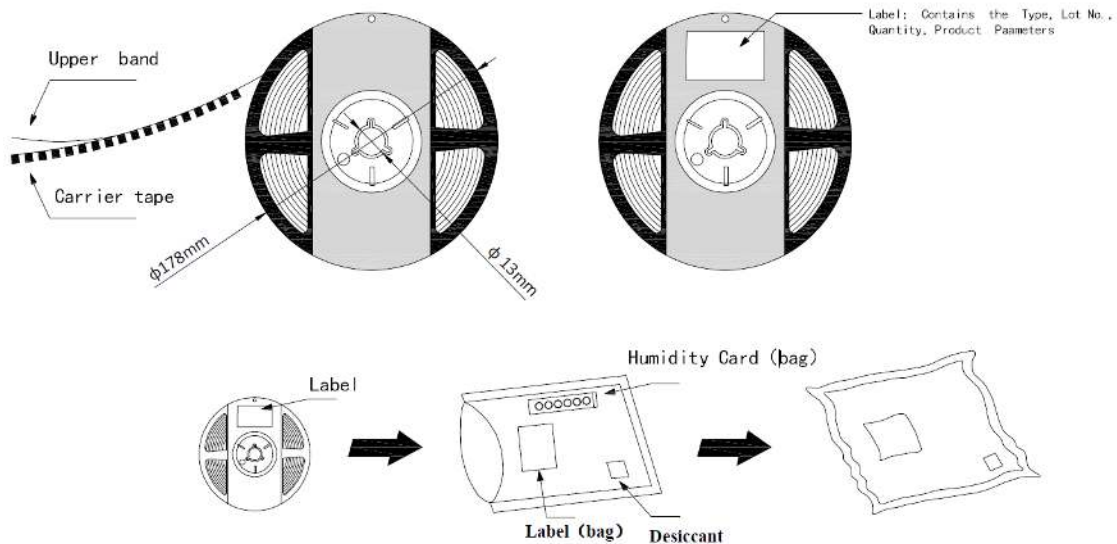



AMERICAN BRIGHT OPTOELECTRONICS CORP.

Packaging

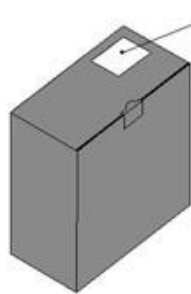
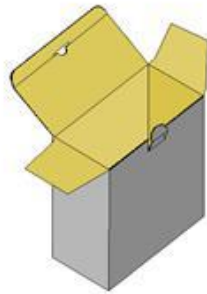

Label Contains Type,
Lot NO, Quantity, Product
Parameters.

* Capacity 4 or 8 reels per box.

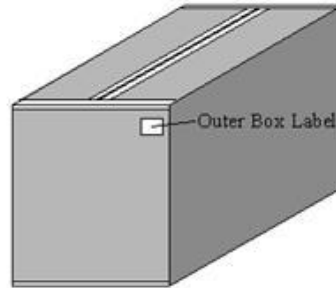
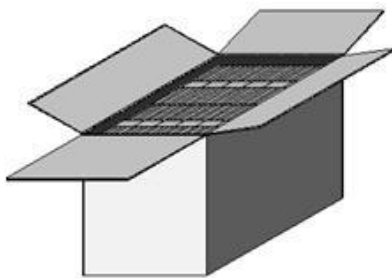

Outer Box Label

* Capacity 48 or 64 reels per box.

America



AMERICAN BRIGHT OPTOELECTRONICS CORP.

Caution

1. Reflow soldering is recommended not to be done more than two times. In the case of more than 24 hours passed soldering after first, LEDs will be damaged.
2. Repairs should not be done after the LEDs have been soldered. When repair is unavoidable, suitable tools must be used.
3. Die slug is to be soldered.
4. When soldering, do not put stress on the LEDs during heating.
5. After soldering, do not warp the circuit board.

Notes on American Bright EMC Series soldering:

1. Recommend to use reflow machine.
2. Recommend to use heating plate soldering.
3. Manual soldering is not recommended.

Notes on reflow process:

1. To confirm whether the actual temperature curve in the reflow soldering conditions comply with recommended conditions. LEDs are guaranteed for one time reflow.
2. During reflow process do not apply force on LED active area.
3. After reflow process, PCB board should be cooled down before packing or storage.

Precaution for use

Storage

1. Before opening the package: The LED should be kept at 5-30°C and 60%RH or less.
2. After opening the package: The LED's lifetime is 168Hrs @30°C or less and 60%RH or less. If unused LED remain, it should be stored in moisture proof packages JEDEC (**MSL 3**).
3. If the moisture absorbent material (silica gel) has faded away or the LEDs have exceeded the storage time, baking treatment should be performed using the following conditions: baking treatment: 60±5°C for 24 hours.