

## Silicon Power Schottky Diode

$V_{RRM} = 20\text{ V} - 40\text{ V}$

$I_{F(AV)} = 600\text{ A}$

### Features

- High Surge Capability
- Types from 20 V to 40 V  $V_{RRM}$
- Isolation Type Package
- Electrically Isolated Base Plate
- Not ESD Sensitive

### Three Tower Package

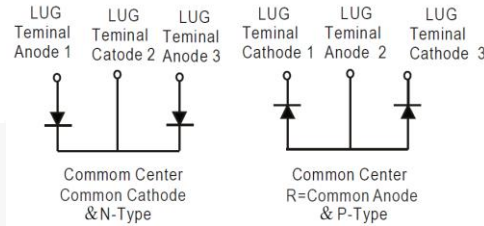

### Maximum ratings, at $T_j = 25\text{ }^\circ\text{C}$ , unless otherwise specified ("R" devices have leads reversed)

Parameter	Symbol	Conditions	MBRT60020(R)	MBRT60030(R)	MBRT60035(R)	MBRT60040(R)	Unit
Repetitive peak reverse voltage	$V_{RRM}$		20	30	35	40	V
RMS reverse voltage	$V_{RMS}$		14	21	25	28	V
DC blocking voltage	$V_{DC}$		20	30	35	40	V
Operating temperature	$T_j$		-55 to 150	-55 to 150	-55 to 150	-55 to 150	$^\circ\text{C}$
Storage temperature	$T_{stg}$		-55 to 150	-55 to 150	-55 to 150	-55 to 150	$^\circ\text{C}$

### Electrical characteristics, at $T_j = 25\text{ }^\circ\text{C}$ , unless otherwise specified

Parameter	Symbol	Conditions	MBRT60020(R)	MBRT60030(R)	MBRT60035(R)	MBRT60040(R)	Unit
Average forward current (per pkg)	$I_{F(AV)}$	$T_C = 125\text{ }^\circ\text{C}$	600	600	600	600	A
Peak forward surge current (per leg)	$I_{FSM}$	$t_p = 8.3\text{ ms}$ , half sine	4000	4000	4000	4000	A
Maximum instantaneous forward voltage (per leg)	$V_F$	$I_{FM} = 300\text{ A}$ , $T_j = 25\text{ }^\circ\text{C}$	0.75	0.75	0.75	0.75	V
Maximum Instantaneous reverse current at rated DC blocking voltage (per leg)	$I_R$	$T_j = 25\text{ }^\circ\text{C}$	1	1	1	1	mA
		$T_j = 100\text{ }^\circ\text{C}$	10	10	10		
		$T_j = 150\text{ }^\circ\text{C}$	50	50	50		

### Thermal characteristics

Maximum thermal resistance, junction - case (per leg)	$R_{\theta JC}$		0.28	0.28	0.28	0.28	$^\circ\text{C/W}$
---	-----------------	--	------	------	------	------	--------------------

Figure.1-Typical Forward Characteristics

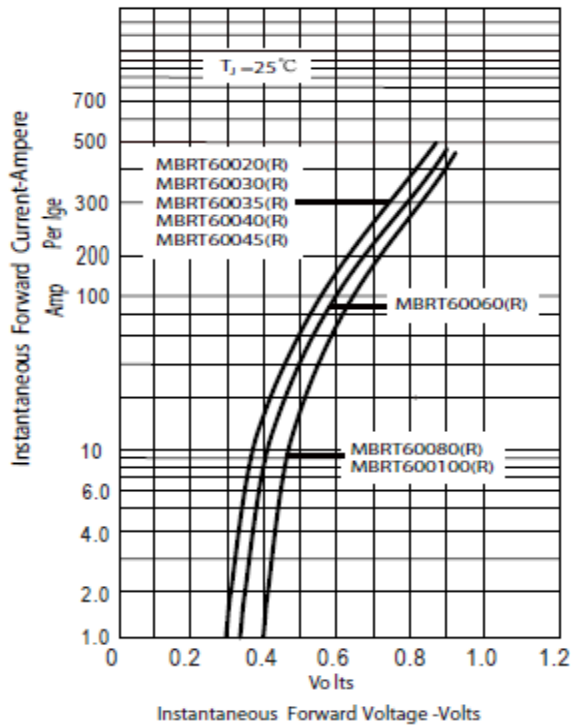

Figure.2-Forward Derating Curve

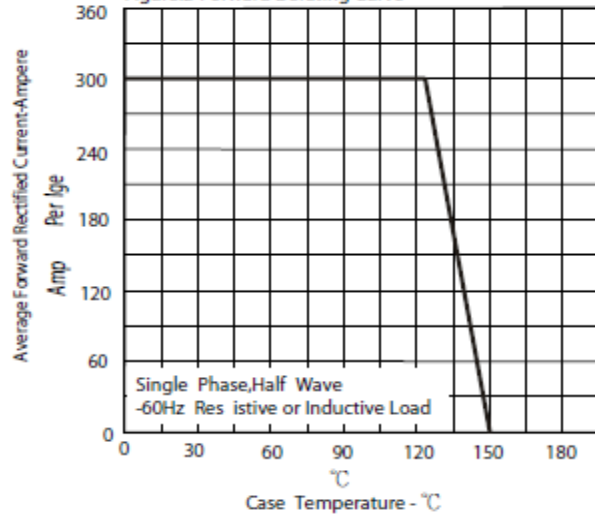

Figure.3-Peak Forward Surge Current

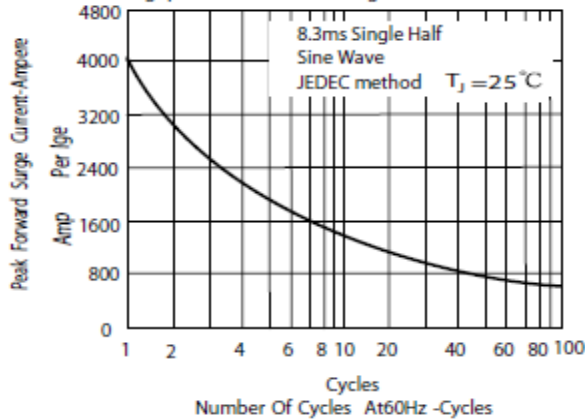
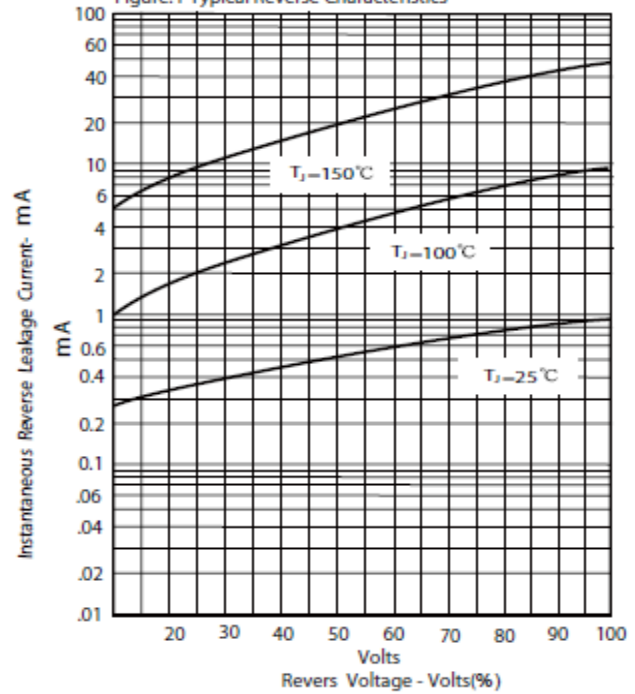
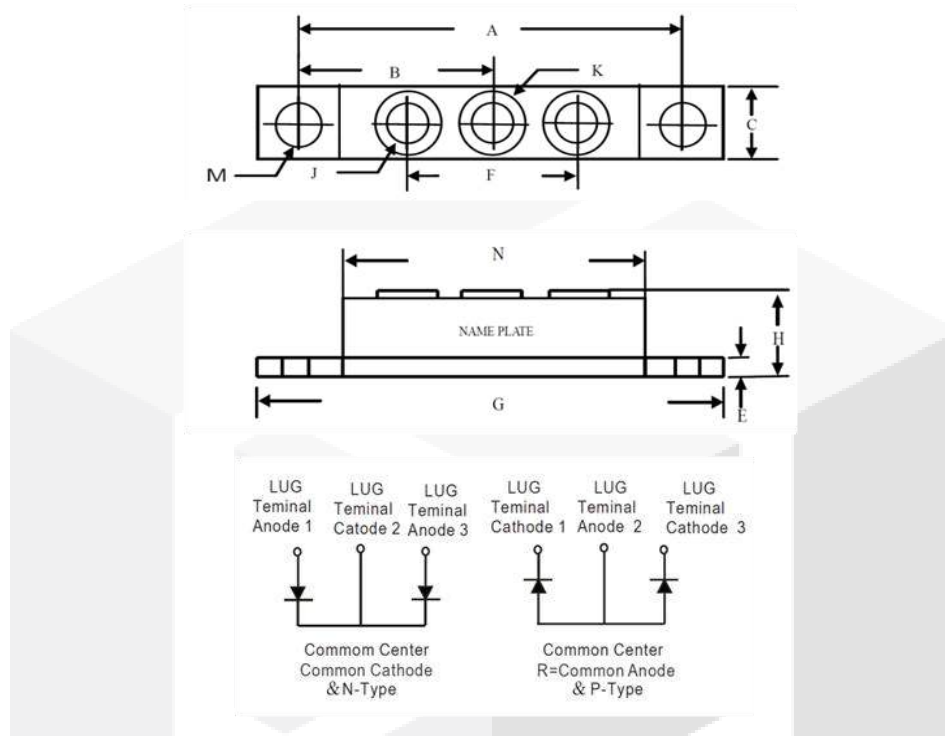

Figure.4-Typical Reverse Characteristics



## Package dimensions and terminal configuration

Product is marked with part number and terminal configuration.



DIM	Inches		Millimeters	
	Min	Max	Min	Max
A	3.150	NOM	80.01	NOM
B	1.565	1.585	39.75	40.26
C	0.700	0.800	17.78	20.32
E	0.119	0.132	3.02	3.35
F	1.327	-----	33.72	-----
G	3.550	3.650	90.17	92.71
H	0.677	0.720	17.20	18.30
J	1/4-20 UNC FULL			
K	0.472	0.511	12	13
M	0.275	0.295	6.99	7.49
N	2.380	2.460	60.5	62.5