



FM TRANSMITTER & RECEIVER HYBRID MODULES.

FM-RTFQ SERIES FM-RRFQ SERIES

- FM Radio Transmitter & Receivers
- Available As 315 or 433 or 868MHz
- Transmit Range Up To 250m
- Miniature Packages
- Data Rate upto 9.6Kbps
- No Adjustable Components
- Very Stable Operating Frequency
- Operates from -20 to $+85^{\circ}\text{C}$

Transmitter

- 3-12 Supply Voltage
- SIL or DIL Package

Receiver

- PLL XTAL Design
- CMOS/TTL Output
- RSSI Output
- **Standby Mode (max 100nA)**
- 5V Supply Voltage

Applications

- Wireless Security Systems
- Car Alarms
- Remote Gate Controls
- Remote Sensing
- Data Capture
- Sensor Reporting

Description

These miniature RF modules provide a cost effective high performance FM Radio data link, at either 315, 433.92 or 868MHz. Manufactured using laser trimmed Thick Film ceramic Hybrid the modules exhibits extremely stable electronic characteristics over an Industrial Temperature range. The hybrid technology uses no adjustable components and ensures very reliable operation.

This transmitter and receiver pair enables the simple implementation of a data link at distances upto 75 metres in-building and 250 metres open ground.

These modules will suit one-to-one and multi-node wireless links in applications including car and building security, EPOS and inventory tracking, remote industrial process monitoring and computer networking. Because of their small size and low power requirements, both modules are ideal for use in portable, battery-powered applications such as hand-held terminals.



RTFQ1

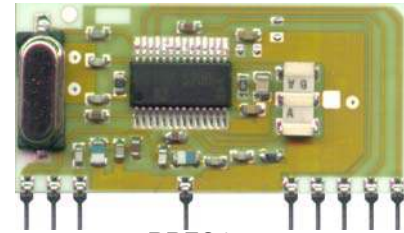

RRFQ1



RTFQ2



RRFQ2



FM TRANSMITTER & RECEIVER HYBRID MODULES.

FM-RTFQ SERIES FM-RRFQ SERIES

Transmitters

There are two versions of transmitter:

- RTFQ1; A Dual in Line Package operating at 3.3V. This provides the most rugged mechanical fixing to the host PCB. Power Down mode is also available.
- RTFQ2; A Single in Line Package incorporating a voltage regulator for 3-12V operation. (Compatible with many other RF transmitter modules available)

Transmitter Block Diagram

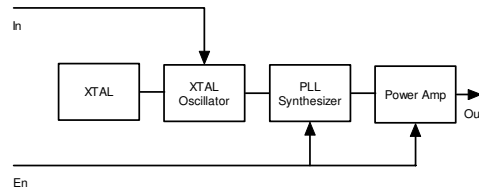

Part Numbering

| Part Number | Description |
|---------------|--|
| FM-RTFQ1-315 | DIL FM Transmitter Module 315 MHz |
| FM-RTFQ1-433 | DIL FM Transmitter Module 433.92 MHz |
| FM-RTFQ1-868 | DIL FM Transmitter Module 868.35 MHz |
| FM-RTFQ2-433R | SIL FM Transmitter Module 433.92 MHz 3-12V I/P |
| FM-RTFQ2-868R | SIL FM Transmitter Module 868.35 MHz 3-12V I/P |

Receivers

There are two versions of receiver:

- RRFQ1: A Single in Line Package with sleep / Power down mode.
- RRFQ2: A Single in Line Package, pin compatible with many other receivers

Receiver Block Diagram

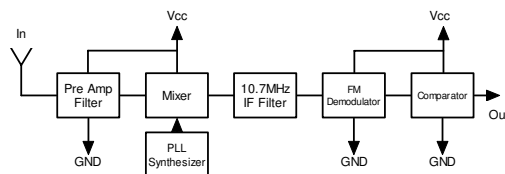

Part Numbering

| Part Number | Description |
|--------------|-----------------------------------|
| FM-RRFQ1-315 | SIL FM Receiver Module 315 MHz |
| FM-RRFQ1-433 | SIL FM Receiver Module 433.92 MHz |
| FM-RRFQ1-868 | SIL FM Receiver Module 868.35 MHz |
| FM-RRFQ2-433 | SIL FM Receiver Module 433.92 MHz |
| FM-RRFQ2-868 | SIL FM Receiver Module 868.35 MHz |





FM TRANSMITTER & RECEIVER HYBRID MODULES.

FM-RTFQ SERIES FM-RRFQ SERIES

RTFQ1 Mechanical Dimensions

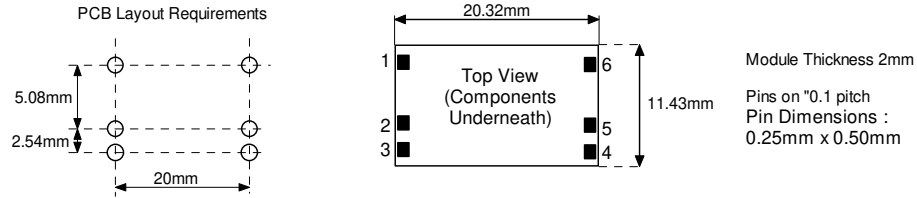

RTFQ2 Mechanical Dimensions

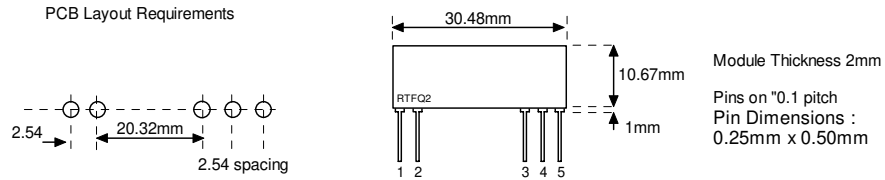

Pin Description

| RTFQ1 | RTFQ2 | Name | Description |
|-------|-------|------|---|
| 1 | N/A | En | Enable (active high) |
| 2 | 5 | IN | Data input |
| 3 | 1 | GND | Ground, Connect to RF earth return path |
| 4 | 3 | Vcc | Supply Voltage |
| 5 | 4 | GND | Ground, Connect to RF earth return path |
| 6 | 2 | EA | External Antenna |

Technical Specifications

| Electrical Characteristics | MIN | TYPICAL | MAX | DIMENSION |
|-------------------------------------|-----|---------------------------|-------|-----------|
| Supply Voltage RTFQ1 | 2.1 | 3.3 | 4.00 | V |
| Supply Voltage RTFQ2 | 2.5 | | 12.00 | V |
| Supply Current | | 7 | 8 | mA |
| Standby Current (IN = EN = Low) | | | 100 | nA |
| Frequency | | 315.0 433.92 868.35 | | MHz |
| RF Output into 50Ω (Vcc=3.3V) | | +5 / +5 / +1 | | dBm |
| Initial Frequency Accuracy | -35 | 0 | +35 | KHz |
| FM Deviation | 25 | 30 | 35 | KHz |
| Harmonic Spurious Emissions | | -50 | | dBc |
| Input High Voltage RTFQ1 | 1.5 | | Vcc | V |
| Input High Voltage RTFQ2 | 1.5 | | 5.5 | V |
| Power up Time (En to full RF) | | | 1 | mS |
| Power up Time (Power on to full RF) | | | 5 | mS |
| Max Data Rate | | | 9.6 | KHz |
| Operating Temperature | -25 | | +80 | °C |





FM TRANSMITTER & RECEIVER HYBRID MODULES.

FM-RTFQ SERIES FM-RRFQ SERIES

RRFQ1 Mechanical Details

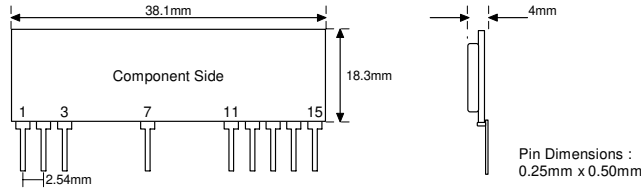

RRFQ2 Mechanical Details

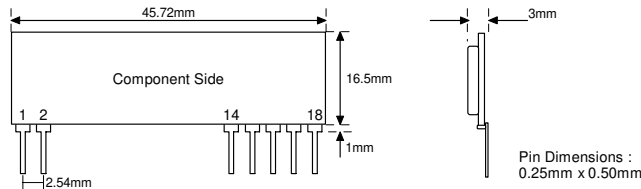

Pin Description

| RRFQ1 | RRFQ2 | Pin Description |
|----------|-------|--|
| 1 | 16 | +Vcc |
| 2, 7, 11 | 2, 15 | GND |
| 3 | 1 | Data In (Antenna) |
| 12 | | NC |
| 13 | 14 | Received Signal Strength Output |
| N/A | 17 | AF Output |
| 14 | 18 | Data Out |
| 15 | N/A | Power Down 0V = Standby 5V = Operating |

RSSI Output

| RF In (dBm) | RSSI (V) |
|-------------|----------|
| -120 | 1.20 |
| -110 | 1.32 |
| -100 | 1.50 |
| -90 | 1.78 |
| -80 | 2.06 |
| -70 | 2.35 |
| -60 | 2.62 |
| -50 | 2.72 |
| -40 | 2.75 |

Technical Specifications

| Electrical Characteristics | Min | Typical | Max | Dimension | Notes |
|--|-------|----------------------------|-------|-----------|-----------|
| Supply Voltage (Vcc) | 4.5 | 5 | 5.5 | V | |
| Supply Current (Operating) | | 5.7 | 6.8 | mA | |
| Supply Current (Standby) | | | 100 | nA | |
| Receiver Frequency | | 315.00 433.92 868.35 | | MHz | |
| R.F Sensitivity (100% AM) 315 ,433MHZ versions 868MHz versions | | -103 -100 | | dBm | |
| 3dB Bandwidth | | +/-150 | | KHz | |
| Data Rate | 300 | | 9,600 | Hz | |
| Turn on Time | | | 5 | mSecs | 1 |
| Turn on Time | | 8 | | mSecs | 2 |
| Level of Emitted Spectrum | | | -70 | dBm | |
| Low Level Output Voltage | | | 0.8 | V | I = 200uA |
| High Level Output Voltage | Vcc-1 | | | V | I = 200uA |
| Operating Temperature Range | -25 | | +80 | °C | |

Notes

1. Time from PD pin going high to stable data. (RRFQ1 only)
2. Time from Poer ON to stable data.



FM TRANSMITTER & RECEIVER HYBRID MODULES.

FM-RTFQ SERIES FM-RRFQ SERIES

Typical Application

The following circuits show a remote control system with 'self learning feature' for more information please see Datasheet DS600

Transmitter Circuit

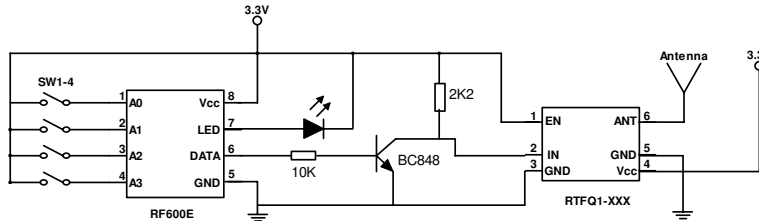

Receiver Circuit

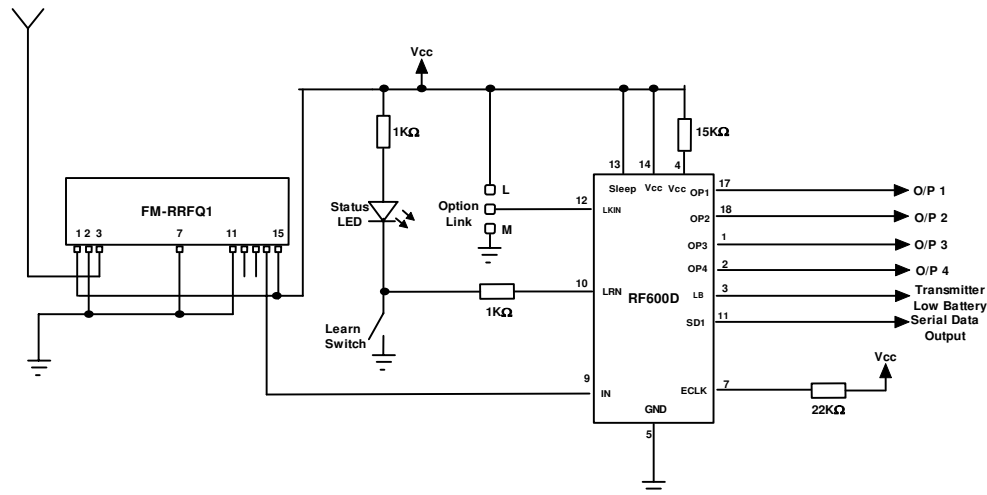

Prototyping Hints:

It is essential when building any Low Power Radio System that you have a 'clean' DC power source. Typically the ripple voltage should be less than 10mV Peak to Peak. Normally a 470uF decoupling capacitor is sufficient de-coupling for an AC derived DC power source.

Never place a Transmitter or Receiver directly into Vero-Board or any similar prototyping board. This will severely restrict the range. Rather, use small lengths of wire from the prototyping board to the pins of the Transmitter or Receiver.

A useful antenna, for testing purposes, for both the Transmitter and Receiver on 433MHz is to use a piece of wire 17.3cm long (23.8cm at 315MHz) soldered directly to the antenna pin.

For more information or general enquiries, please contact;

RF Solutions Ltd.,
Unit 21, Cliffe Industrial Estate,
South Street, Lewes, E Sussex, BN8 6JL. England
Tel +44 (0)1273 898 000 Fax +44 (0)1273 480 661

Email sales@rfsolutions.co.uk

<http://www.rfsolutions.co.uk>

RF Solutions is a member of the Low Power Radio Association
All Trademarks acknowledged and remain the property of the respected owners

Information contained in this document is believed to be accurate, however no representation or warranty is given and R.F. Solutions Ltd. assumes no liability with respect to the accuracy of such information. Use of R.F. Solutions as critical components in life support systems is not authorised except with express written approval from R.F. Solutions Ltd.