

Image-Reject Mixer

15 to 45 GHz



MAMX-011043

Rev. V2

Features

- Ultra-Wideband 15-45 GHz RF/LO range
- LO Power Operating Range: 12 - 18 dBm
- Low Conversion Loss: 9 dB typical
- High Linearity: 18 dBm IIP3 typical
- High Image Rejection: 20 dBc typical
- Wide IF Bandwidth: DC to 10 GHz
- High Isolation
- Package Size: 4 x 4 mm QFN
- RoHS* Compliant

Applications

- Test & Measurement, Microwave Radio, and Radar

Description

MAMX-011043 is an image-reject passive diode mixer MMIC. The mixer operates over an ultrawide bandwidth of 15 - 45 GHz. LO operating range is 12 dBm to 18 dBm. The mixer offers low conversion loss, good linearity and excellent image rejection over the 15 - 45 GHz range. The MAMX-011043 also operates up to 10 GHz IF. The image-reject circuit configuration provides excellent port isolation while internal 50 Ω matching simplifies its application.

Ordering Information^{1,2}

Part Number	Package
MAMX-011043	Bulk
MAMX-011043-TR0100	100 Piece Reel
MAMX-011043-TR0500	500 Piece Reel
MAMX-011043-SB1	Sample Board

1. Reference Application Note M513 for reel size information.
2. All sample boards include 5 loose parts.

Functional Schematic

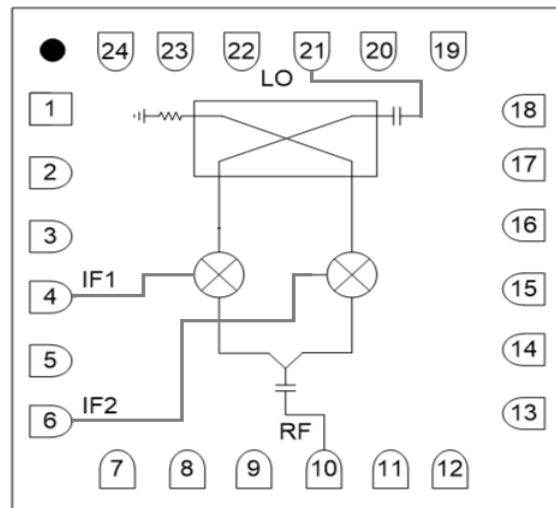

Pin Configuration³

Pin #	Function
1 - 3	Ground
4	IF1
5	Ground
6	IF2
7 - 9	Ground
10	RF
11 - 20	Ground
21	LO
22 - 24	Ground
25	Paddle ⁴

3. MACOM recommends connecting unused package pins to ground.
4. The exposed pad centered on the package bottom must be connected to RF, DC and thermal ground.

* Restrictions on Hazardous Substances, compliant to current RoHS EU directive.

Electrical Specifications⁵: $F_{IF} = 100 \text{ MHz}$, $P_{LO} = +16 \text{ dBm}$, $T_A = +25^\circ\text{C}$, $Z_0 = 50 \Omega$

Parameter	Test Conditions	Units	Min.	Typ.	Max.
LO and RF Frequency	—	GHz	15	—	45
IF Frequency	—	GHz	0	—	10
LO Power	—	dBm	—	16	—
Conversion Loss	—	dB	—	9	10.5
Input P1dB	—	dBm	—	8	—
Input IP3	$P_{RF} = -10 \text{ dBm/tone}$, $\Delta f = 1 \text{ MHz}$	dBm	—	18	—
Input IP2	—	dBm	—	40	—
LO-to-RF Isolation	—	dB	—	40	—
LO-to-IF Isolation	—	dB	—	40	—
RF-to-IF Isolation	—	dB	—	30	—
Image Rejection	—	dBc	15	20	—
Amplitude Imbalance	—	dB	—	± 1	—
Phase Imbalance	—	°	—	± 10	—

5. All specifications refer to down-conversion operation, unless otherwise noted.

Absolute Maximum Ratings^{4,5}

Parameter	Absolute Maximum
LO Power	23 dBm
RF or IF Power	20 dBm
Junction Temperature ⁶	+150°C
Operating Temperature	-40°C to +85°C
Storage Temperature	-65°C to +150°C

4. Exceeding any one or combination of these limits may cause permanent damage to this device.
5. MACOM does not recommend sustained operation near these survivability limits.
6. Operating at nominal conditions with $T_J \leq +150^\circ\text{C}$ will ensure $\text{MTTF} > 1 \times 10^6$ hours. Thermal resistance, Θ_{JC} is 85°C/W .

Handling Procedures

Please observe the following precautions to avoid damage:

Static Sensitivity

These electronic devices are sensitive to electrostatic discharge (ESD) and can be damaged by static electricity. Proper ESD control techniques should be used when handling these HBM Class 1A devices.

Assembly Information

- Do not subject the device to excessive force, especially at elevated temperatures $> 60^\circ\text{C}$.
- No-clean flux is required for assembly. Post SMT washing is not recommended.

Image-Reject Mixer

15 to 45 GHz



MAMX-011043

Rev. V2

Typical Performance Curves Lower Side Band (LSB) High Side LO Data captured with 90° hybrid at 100 MHz IF

Down Conversion Gain over LO drive

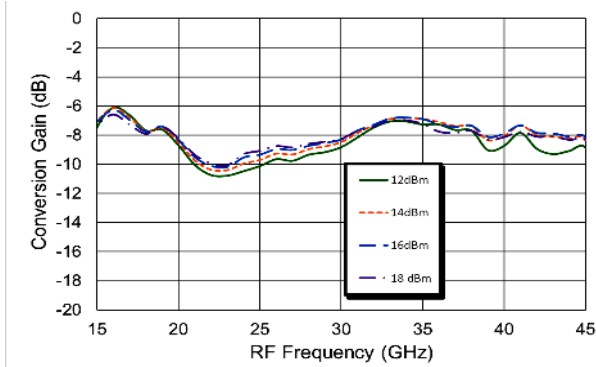

Down Conversion Image Rejection over LO drive

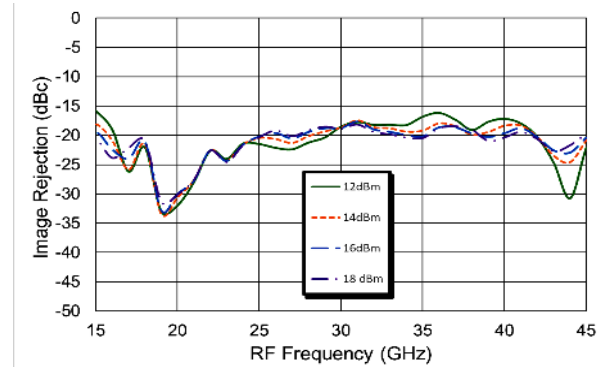

IIP3 over LO drive

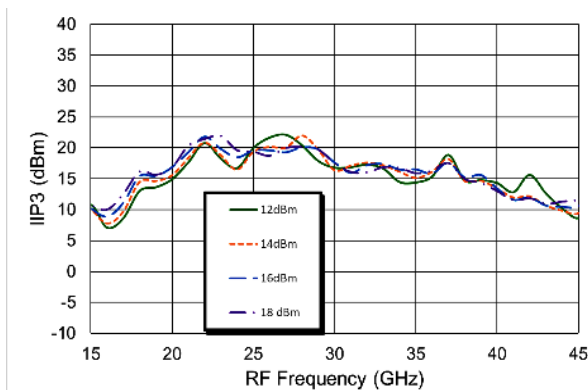

IIP2 over LO drive

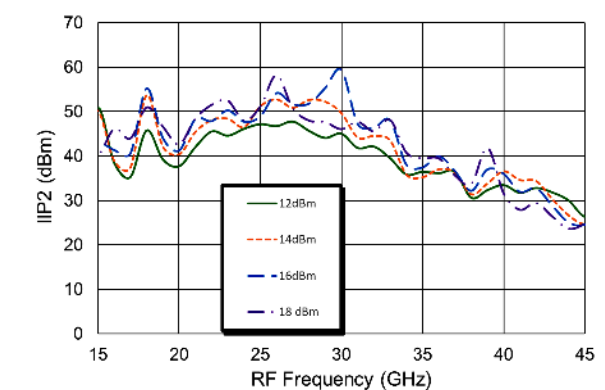

Amplitude Imbalance over LO drive*

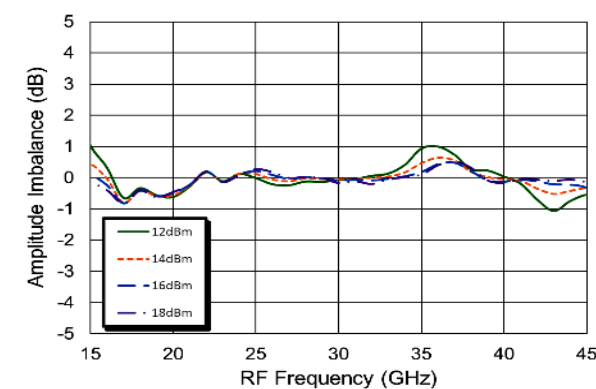

Phase Imbalance over LO drive*

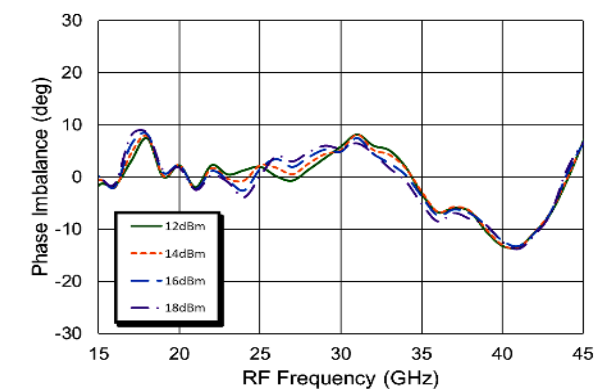

* Data captured without hybrid

Image-Reject Mixer 15 to 45 GHz



MAMX-011043

Rev. V2

Typical Performance Curves Lower Side Band (LSB) High Side LO Data captured with 90° hybrid at 100 MHz IF, LO Power 16 dBm

Down Conversion Gain over temperature

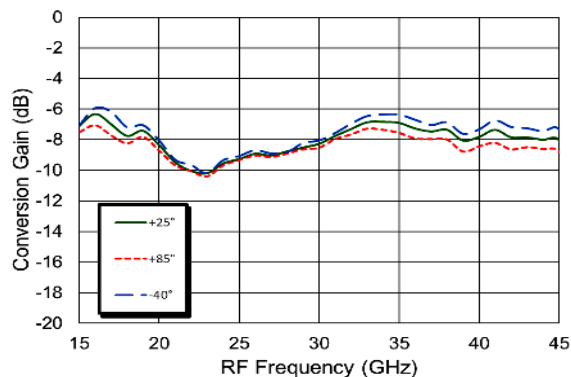

Down Conversion Image Rejection over temperature

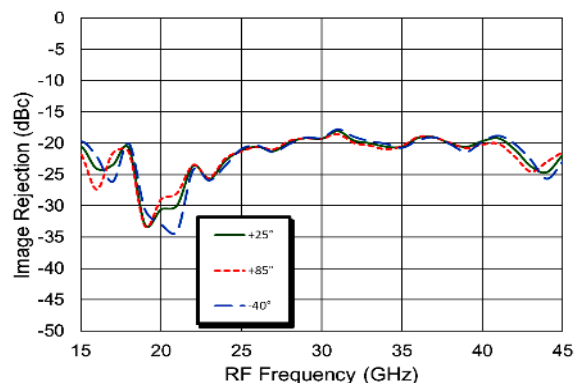

IIP3 over temperature

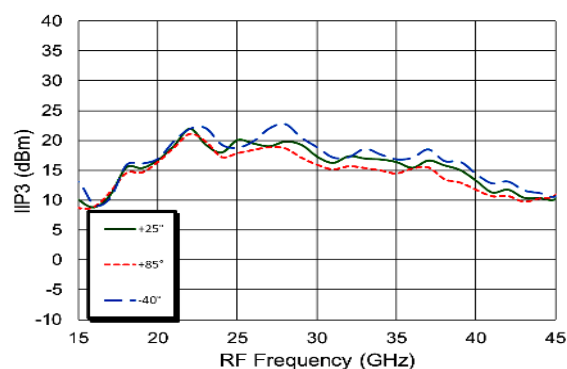

IIP2 over temperature

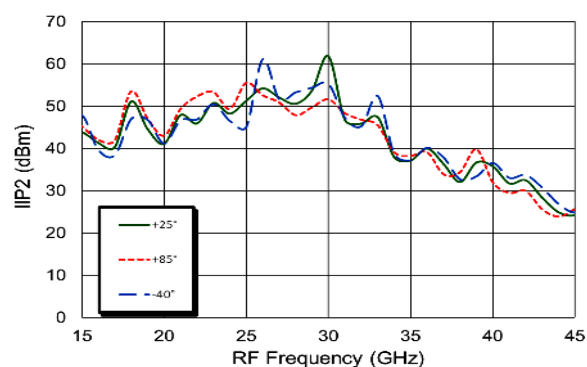

Image-Reject Mixer 15 to 45 GHz



MAMX-011043

Rev. V2

Typical Performance Curves Upper Side Band (USB) Low Side LO Data captured with 90° hybrid at 100 MHz IF

Down Conversion Gain over LO drive

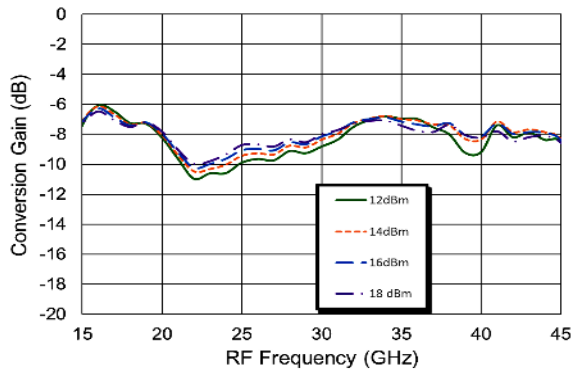

Down Conversion Image Rejection over LO drive

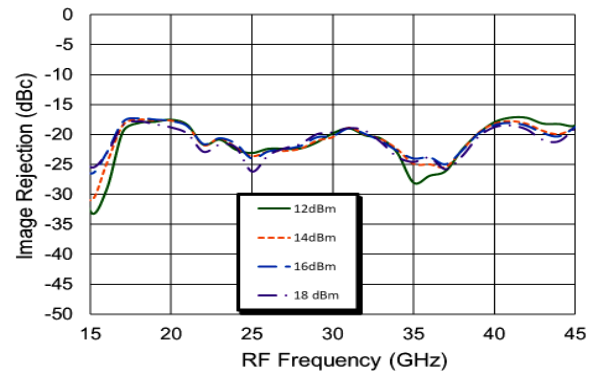

IIP3 over LO drive

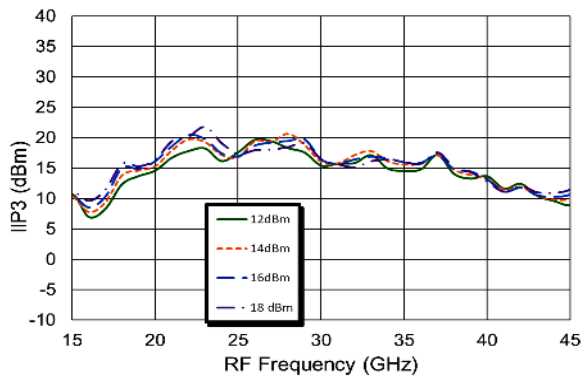

IIP2 over LO drive

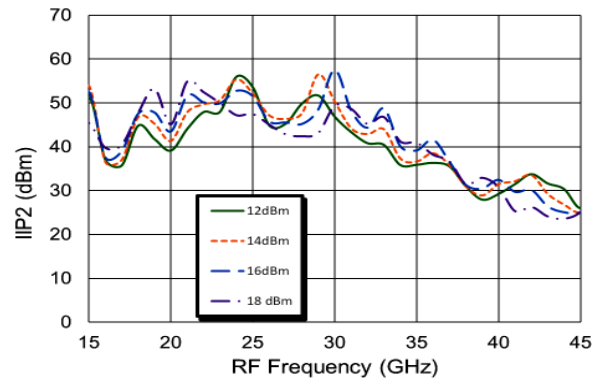

Amplitude Imbalance over LO drive*

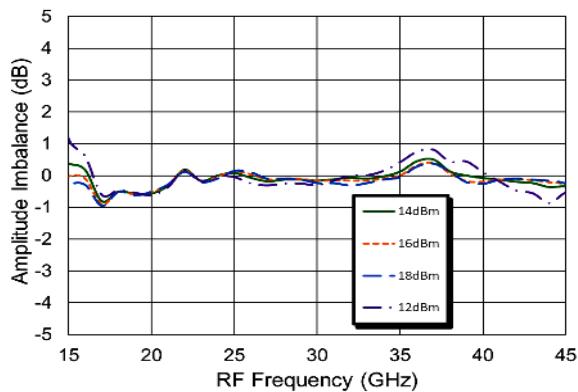

Phase Imbalance over LO drive*

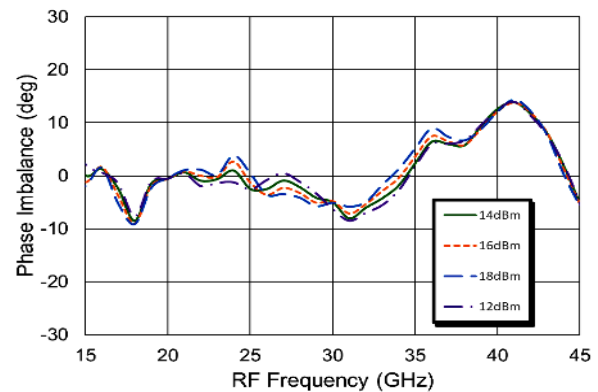

* Data captured without hybrid

Image-Reject Mixer 15 to 45 GHz



MAMX-011043

Rev. V2

Typical Performance Curves Upper Side Band (USB) Low Side LO Data captured with 90° hybrid at 100 MHz IF, LO Power 16 dBm

Down Conversion Gain over temperature

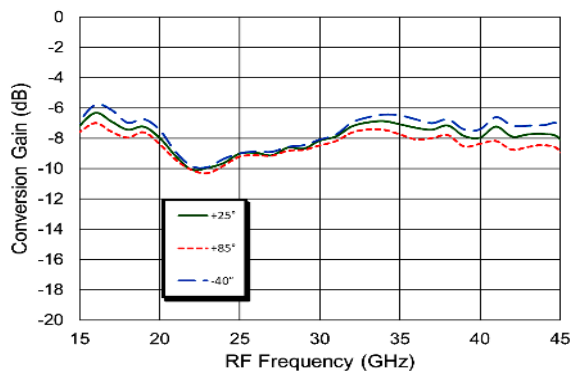

Down Conversion Image Rejection over temperature

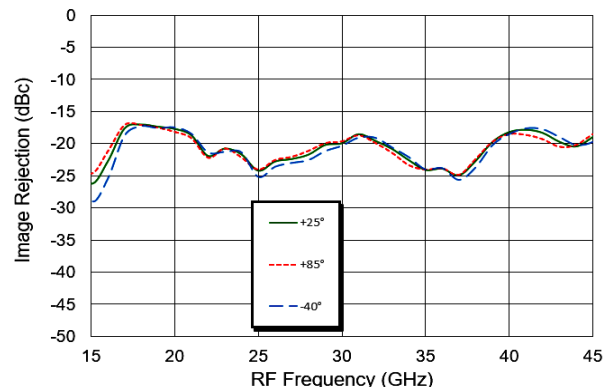

IIP3 over temperature

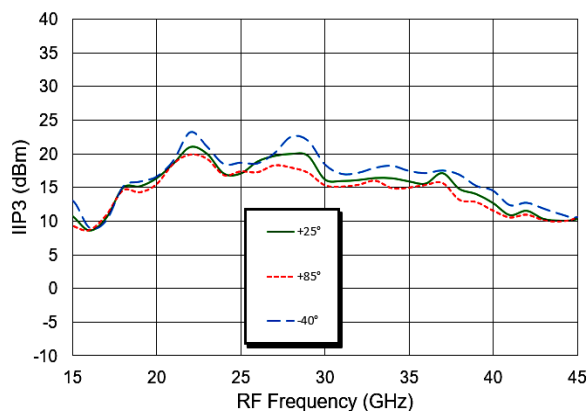

IIP2 over temperature

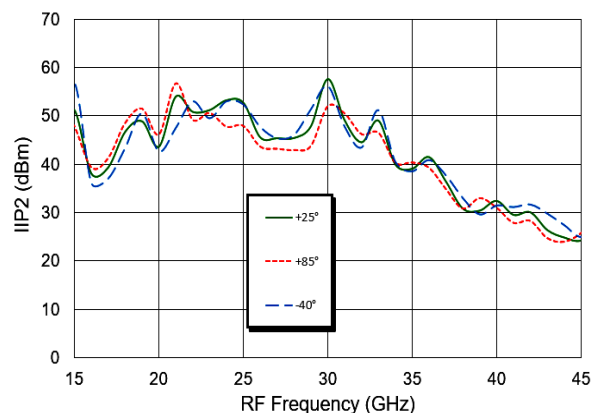

Typical Performance Curves Lower Side Band (LSB) High Side LO

Data captured with 90° hybrid at 100 MHz IF

Up Conversion Gain over LO drive

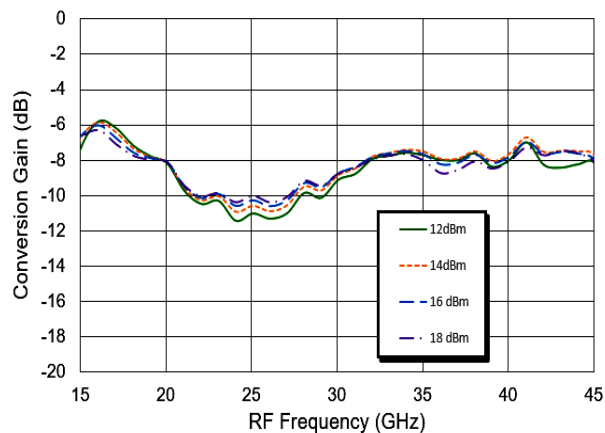

Up Conversion SSB over LO drive

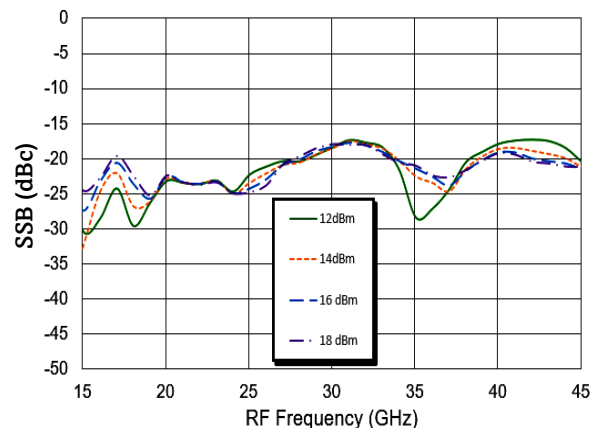

Typical Performance Curves Upper Side Band (USB) Low Side LO

Data captured with 90° hybrid at 100 MHz IF

Up Conversion Gain over LO drive

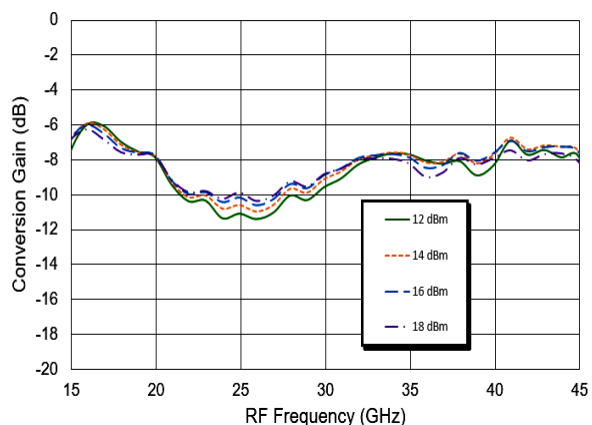

Up Conversion SSB over LO drive

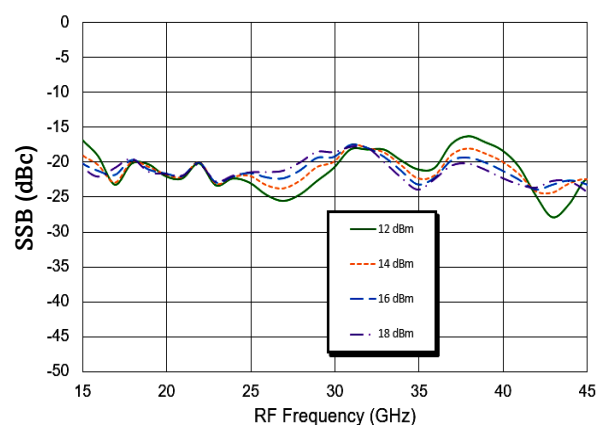

Typical Performance Curves Lower Side Band (LSB) High Side LO Data captured with 90° hybrid at 5 GHz IF

Down Conversion Gain over LO drive

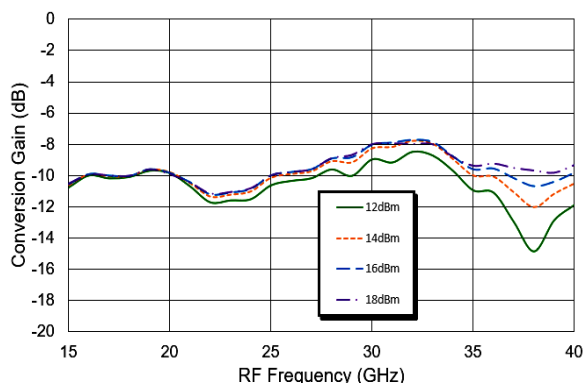

Down Conversion Image Rejection over LO drive

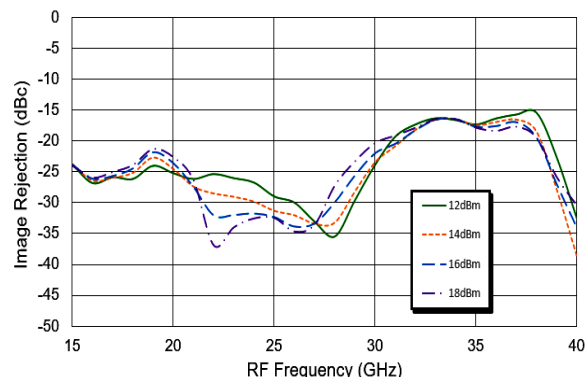

IIP3 over LO drive

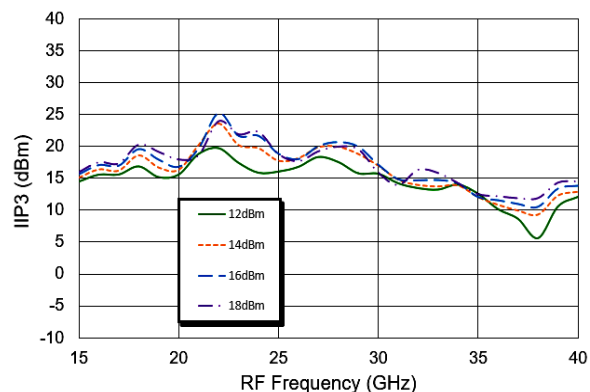

IIP2 over LO drive

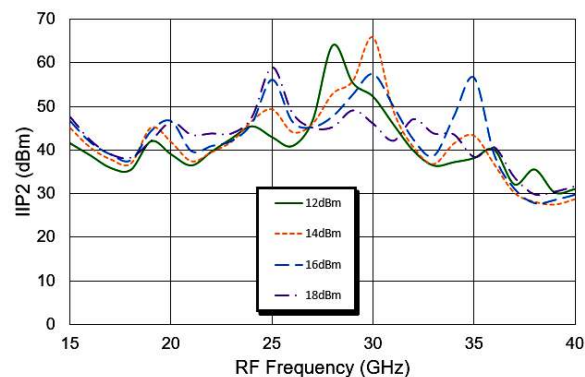

Typical Performance Curves Upper Side Band (USB) Low Side LO Data captured with 90° hybrid at 5 GHz IF

Down Conversion Gain over LO drive

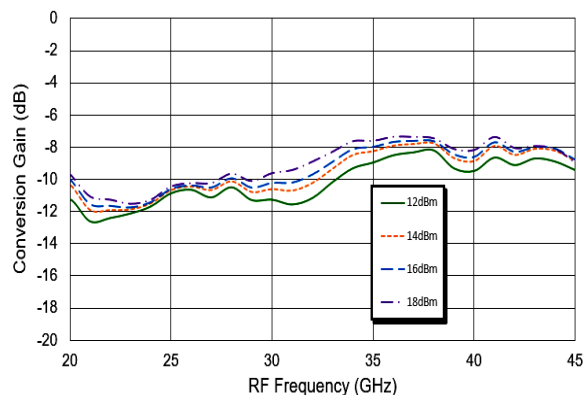

Down Conversion Image Rejection over LO drive

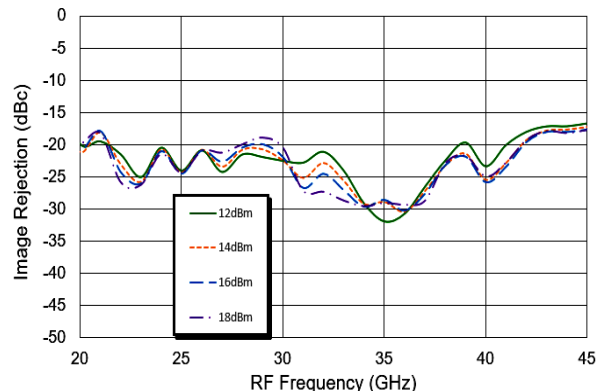

IIP3 over LO drive

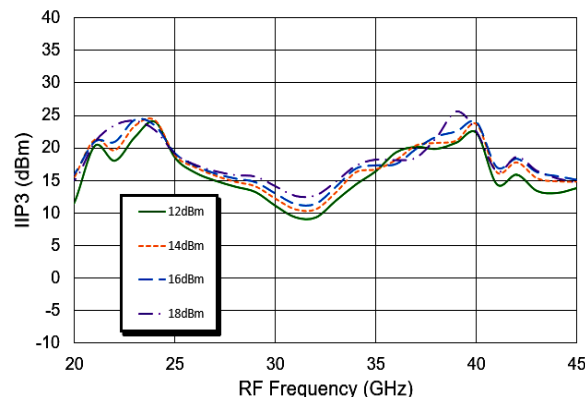

IIP2 over LO drive

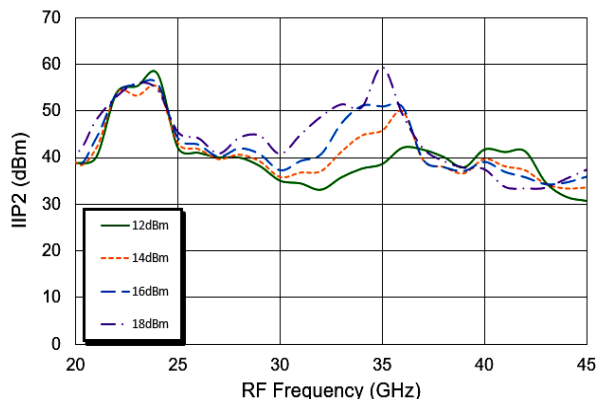

Image-Reject Mixer 15 to 45 GHz



MAMX-011043

Rev. V2

Typical Performance Curves Lower Side Band (LSB) High Side LO Data captured with 90° hybrid at 10 GHz IF

Down Conversion Gain over LO drive

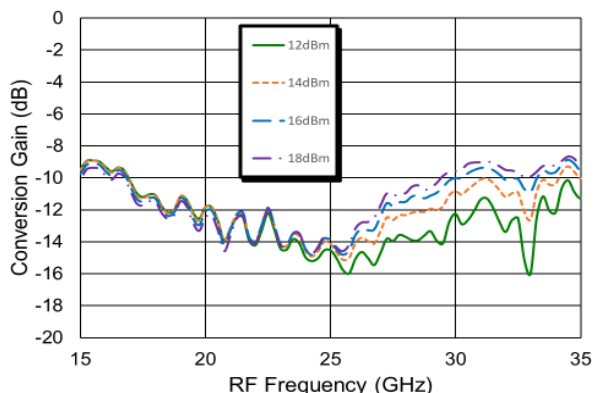

Down Conversion Image Rejection over LO drive

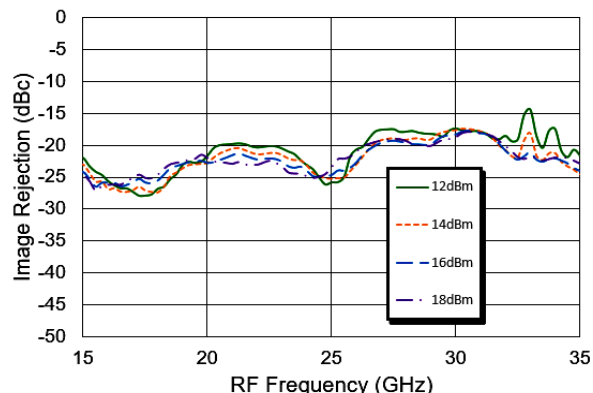

IIP3 over LO drive

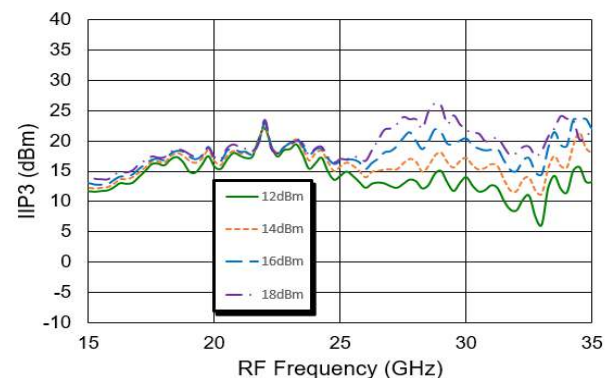

IIP2 over LO drive

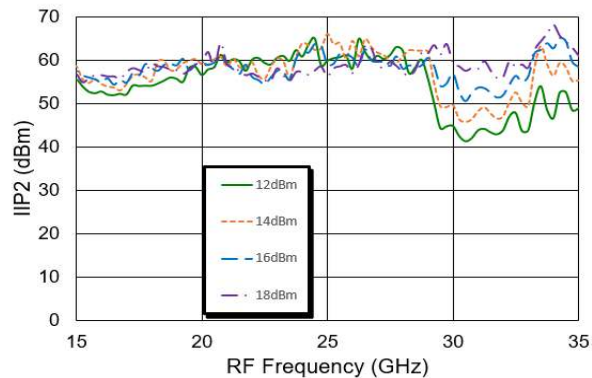

Image-Reject Mixer 15 to 45 GHz



MAMX-011043

Rev. V2

Typical Performance Curves Upper Side Band (USB) Low Side LO Data captured with 90° hybrid at 10 GHz IF

Down Conversion Gain over LO drive

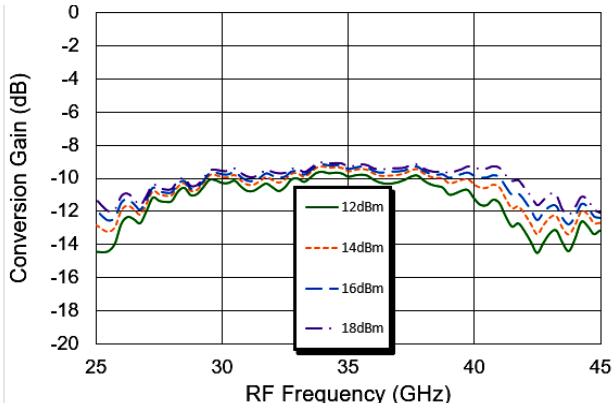

Down Conversion Image Rejection over LO drive

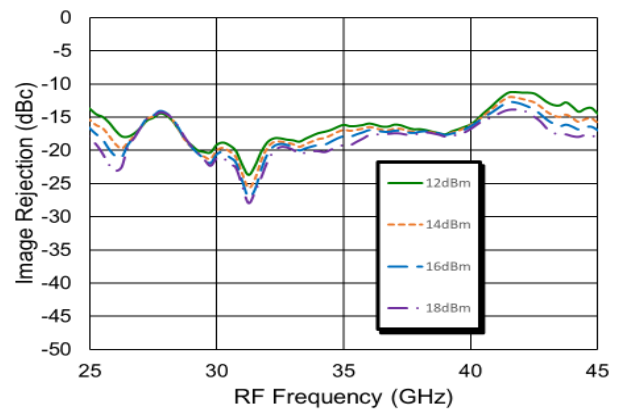

IIP3 over LO drive

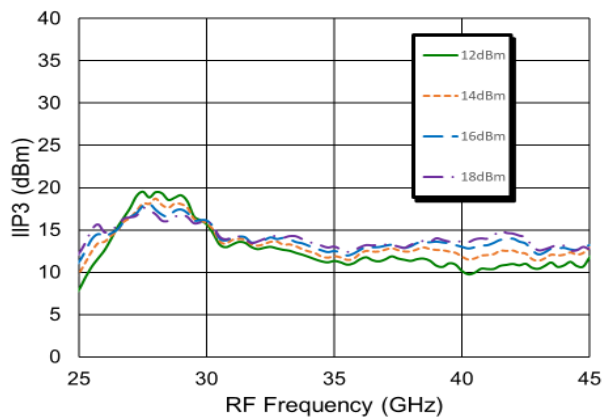

IIP2 over LO drive

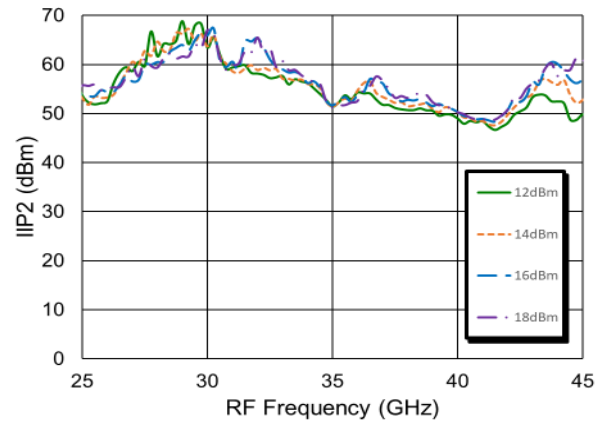

Typical Performance Curves

Isolations

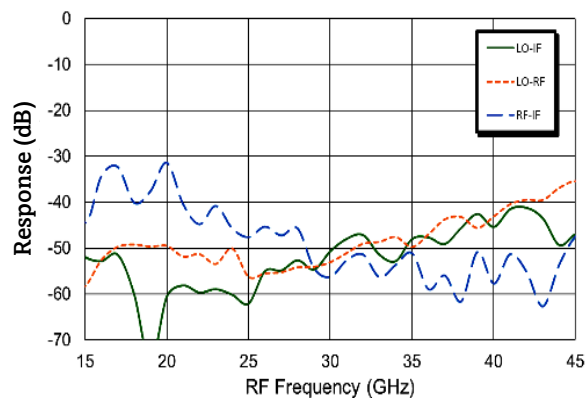

IF Bandwidth

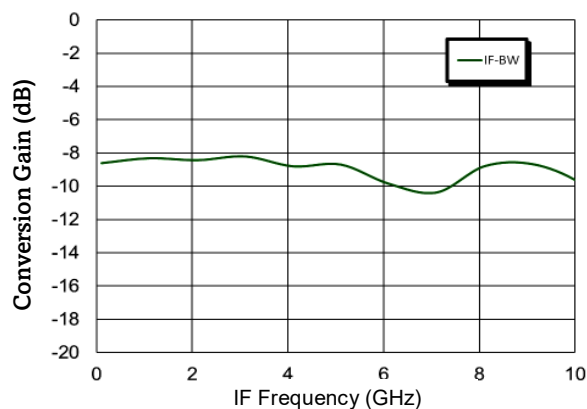

RF Return Loss

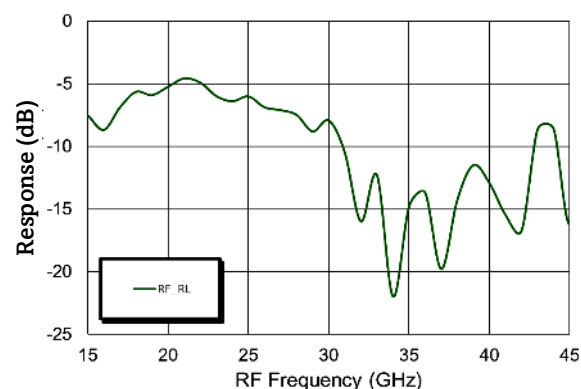

P1dB vs. LO power

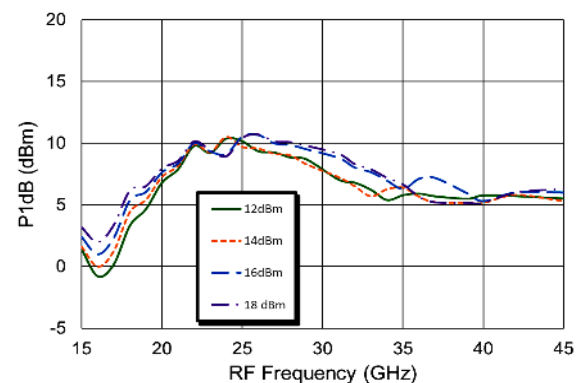

IF Return Loss

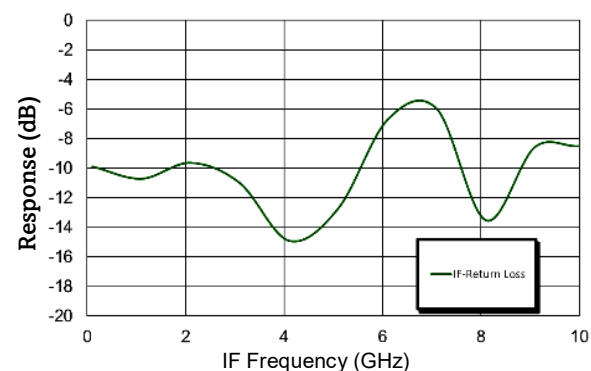

Image-Reject Mixer 15 to 45 GHz



MAMX-011043

Rev. V2

MxN Spurious Rejection at IF port

RF 15.1 GHz at -10 dBm, LO 15 GHz at +16 dBm
All values in dBc below the IF output power level

mxRF	nxLO				
	0	1	2	3	4
0	x	27.6	60.1	64.5	x
1	25.0	0	44.3	x	x
2	x	76.1	x	70.2	x
3	x	x	72.1	53.3	x
4	x	x	x	x	81.2

LO Harmonics

LO +16 dBm
Values in dBc below input LO level measured at RF

LO GHz	n LO spur at RF port			
	1	2	3	4
14	52	60	N/A	N/A
16	52	58	54	N/A
18	50	49	N/A	N/A
20	51.3	46.7	N/A	N/A
22	51	43	N/A	N/A
24	54	44	N/A	N/A
26	52	N/A	N/A	N/A
30	46	N/A	N/A	N/A
45	39	N/A	N/A	N/A

Sample Board

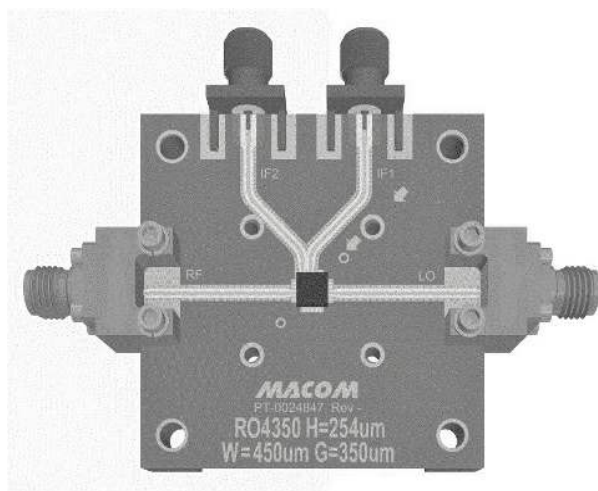

- Material: Rogers 4350B
- Dielectric thickness 0.254 mm
- Finished copper thickness 17 microns (0.5 oz) plated to 44 microns +/- 10 microns
- Finish both sides: ENIG, 0.05 - 0.15 μm gold over 3 - 6 μm nickel
- DXF available on request

Application Schematic

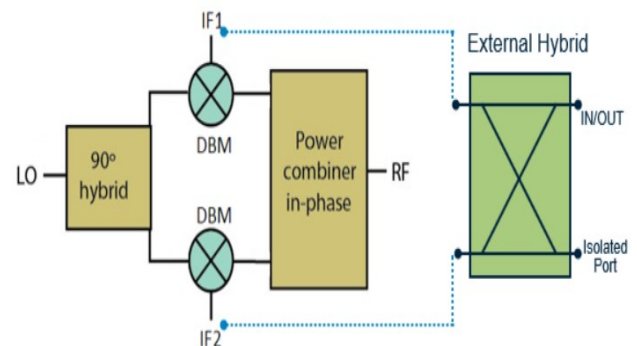

External Hybrid

- Down conversion and Up conversion data captured with external hybrid 90° coupler part number: Innovative IPP-2345.
- RF Upper Side Band (USB) mode connect hybrid 0° port to IF1 mixer port, 90° hybrid port to IF2 mixer port. Output on In/Out port, image at isolated port.
- RF Lower Side Band (LSB) mode connect hybrid 0° port to IF2 mixer port, 90° hybrid port to IF1 mixer port. Output on In/Out port, image at isolated port.

Image-Reject Mixer 15 to 45 GHz



MAMX-011043

Rev. V2

Lead-Free 4 mm 24-Lead AQFN†

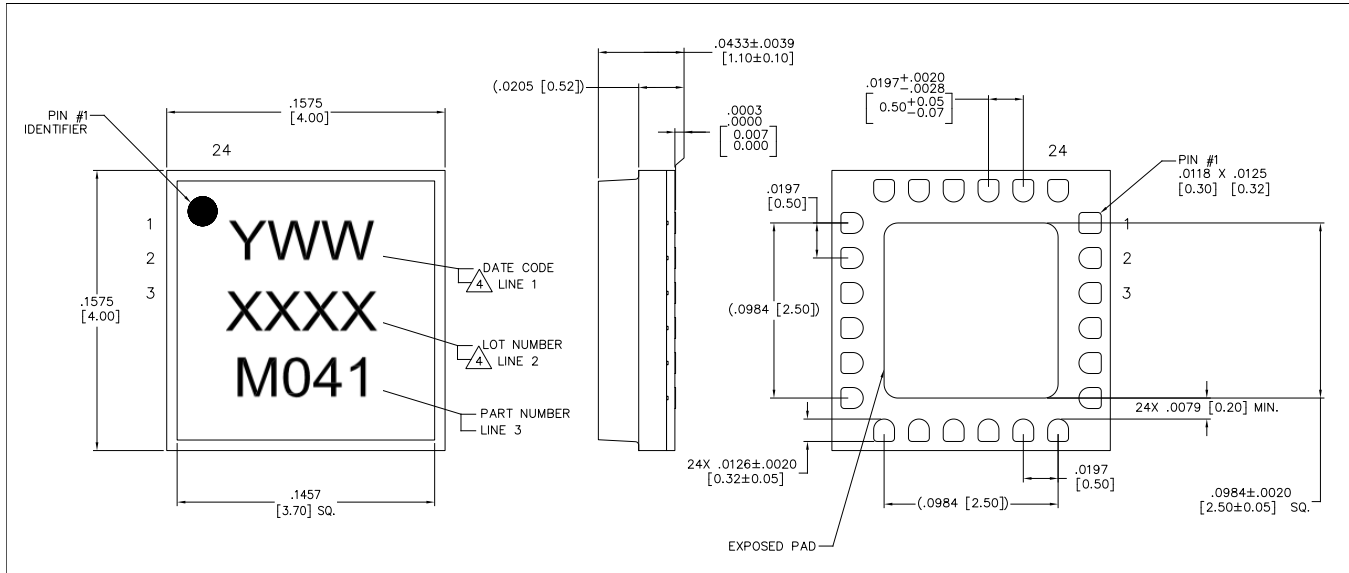

† Reference Application Note S2083 for lead-free solder reflow recommendations.
Meets JEDEC moisture sensitivity level 3 requirements.
Plating is NiPdAu

MACOM Technology Solutions Inc. ("MACOM"). All rights reserved.

These materials are provided in connection with MACOM's products as a service to its customers and may be used for informational purposes only. Except as provided in its Terms and Conditions of Sale or any separate agreement, MACOM assumes no liability or responsibility whatsoever, including for (i) errors or omissions in these materials; (ii) failure to update these materials; or (iii) conflicts or incompatibilities arising from future changes to specifications and product descriptions, which MACOM may make at any time, without notice. These materials grant no license, express or implied, to any intellectual property rights.

THESE MATERIALS ARE PROVIDED "AS IS" WITH NO WARRANTY OR LIABILITY, EXPRESS OR IMPLIED, RELATING TO SALE AND/OR USE OF MACOM PRODUCTS INCLUDING FITNESS FOR A PARTICULAR PURPOSE, MERCHANTABILITY, INFRINGEMENT OF INTELLECTUAL PROPERTY RIGHT, ACCURACY OR COMPLETENESS, OR SPECIAL, INDIRECT, INCIDENTAL, OR CONSEQUENTIAL DAMAGES WHICH MAY RESULT FROM USE OF THESE MATERIALS.

MACOM products are not intended for use in medical, lifesaving or life sustaining applications. MACOM customers using or selling MACOM products for use in such applications do so at their own risk and agree to fully indemnify MACOM for any damages resulting from such improper use or sale.