



# EVQ7200-L-00B

## 42V, 1.2A, Synchronous LED Driver Buck-Boost Mode Evaluation Board

### DESCRIPTION

The EVQ7200-L-00B evaluation board is designed to demonstrate the capabilities of the MPQ7200-AEC1. The MPQ7200-AEC1 is a high-frequency, constant-current LED driver with integrated power MOSFETs. It offers a very compact solution to achieve a 1.2A continuous output, with excellent load and line regulation across a wide input supply range.

Constant frequency hysteretic control mode provides extremely fast transient response without the loop compensation. The switching frequency is 1.15MHz in buck-boost mode for optimized efficiency and thermal performance.

The EVQ7200-L-00B is a fully assembled and tested buck-boost mode LED driver evaluation board. It generates an LED current up to 1.2A from a 6V to 20V input range.

### ELECTRICAL SPECIFICATIONS

Parameter	Symbol	Value	Units
Input voltage	V <sub>EMI</sub>	6 to 20	V
Output current	I <sub>LED</sub>	1.2	A
Output voltage	V <sub>LED</sub>	3 to 15	V

### FEATURES

- Wide 6V to 42V Operating Input Range
- Buck-Boost Mode: Configurable 1.2A Max Continuous Output Current
- 44mΩ/40mΩ Internal Power MOSFETs
- Default 1.15MHz Switching Frequency for Buck-Boost Mode with Spread Spectrum
- PWM Dimming (100Hz to 2kHz Dimming Frequency)
- Internal 500Hz Two-Step Dimming with Programmable Duty Cycle
- Fault Indication for LED Short (to GND & Battery), Open, Output Over-voltage and Thermal Shutdown
- Over-Current Protection (OCP)
- Programmable Thermal Derating via NTC Remote Temperature Sensing
- EMI Reduction
- Available in a QFN-19 (3mmx4mm) Wettable Flank Package
- Available in AEC-Q100 Grade 1

### APPLICATIONS

- Automotive LED Lighting

All MPS parts are lead-free, halogen-free, and adhere to the RoHS directive. For MPS green status, please visit the MPS website under Quality Assurance. "MPS", the MPS logo, and "Simple, Easy Solutions" are trademarks of Monolithic Power Systems, Inc. or its subsidiaries.

### EVQ7200-L-00B EVALUATION BOARD



(LxWxH) 8.3cmx8.3cmx1.3cm

Board Number	MPS IC Number
EVQ7200-L-00B	MPQ7200GLE-AEC1

### Efficiency vs. Input Voltage vs. Power Loss

4 LEDs (V<sub>LED</sub> = 12V), buck-boost mode

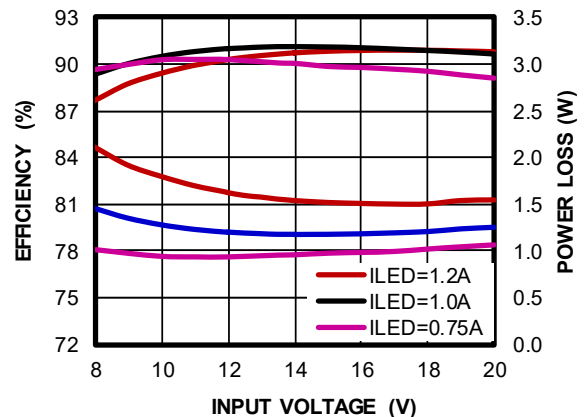

## QUICK START GUIDE

1. Preset the power supply between 6V and 20V. Note that the input voltage ( $V_{IN}$ ) plus output voltage ( $V_{OUT}$ ) should be less than 40V.
2. Turn off the power supply.
3. If longer cables (>0.5m total) are used between the source and the EVB, install a damping capacitor at the input terminals. This is especially critical when  $V_{EMI}$  exceeds 24V.
4. Connect the power supply terminals to:
  - a. Positive (+): VEMI
  - b. Negative (-): GND
5. Connect the load terminals to:
  - a. Positive (+): LED+
  - b. Negative (-): LED-
6. After making the connections, turn on the power supply.
7. To use the enable function:
  - a. Apply a digital input to the EN/DIM pin.
  - b. Drive EN above 2.5V to turn the regulator on; drive EN below 1V to turn it off.
8. When two-step dimming is inactivated ( $R_{DUTY} = 4.87k\Omega$ ), an external 100Hz to 2kHz PWM waveform can be applied to the EN/DIM pin.
9. Table 1 shows the proposed R3 in E96 series for different two-step dimming duty. When EN/DIM is high, the dimming duty cycle is 100%. When EN/DIM is low, the dimming duty cycle is X% shown in Table 1.

**Table 1: Two-Step Dimming Duty vs.  $R_{DUTY}$**

Two-Step Dimming Duty (X%)	$R_{DUTY}$ ( $\Omega$ )
15%	61900
14%	41200
13%	27400
12%	18200
11%	12100
10%	7870
PWM dimming (two-step dimming inactivated)	4870
9%	3090
8%	2050
7%	1370
6%	887
5%	576

10. The external resistor ( $R5$ ) connected to the ISET pin sets the LED current ( $I_{LED}$ ). Generally, the value of  $R5$  can be calculated with Equation (1):

$$R5 = \frac{16}{I_{LED}(A)} (k\Omega) \quad (1)$$

## QUICK START GUIDE *(continued)*

To get better LED current precision, Table 2 shows the recommended LED setting resistor value in buck-boost mode when  $I_{LED}$  is below 0.7A (see Figure 1).

**Table 2: Resistor Selection when  $I_{LED} \leq 700\text{mA}$  in Buck-Boost Mode**

$I_{LED}$ (A)	$R_{SET}$ (k $\Omega$ )
0.7	22.6
0.65	24.2
0.6	26.1
0.55	28.2
0.5	30.9
0.45	34.0
0.4	37.4

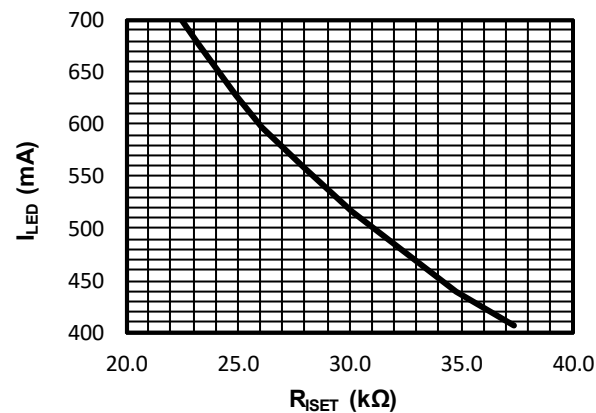

**Figure 1:  $I_{LED}$  vs.  $R_{SET}$  when  $I_{LED} \leq 700\text{mA}$  in Buck-Boost Mode**

### EVALUATION BOARD SCHEMATIC

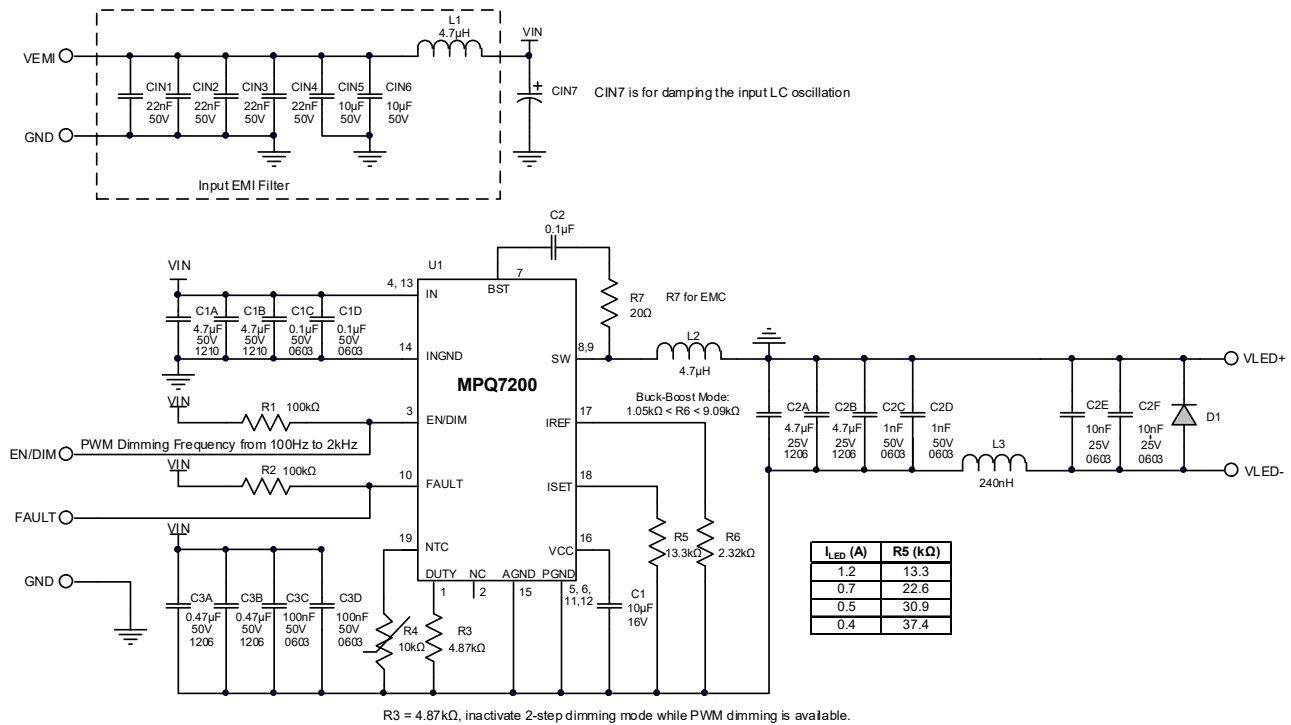
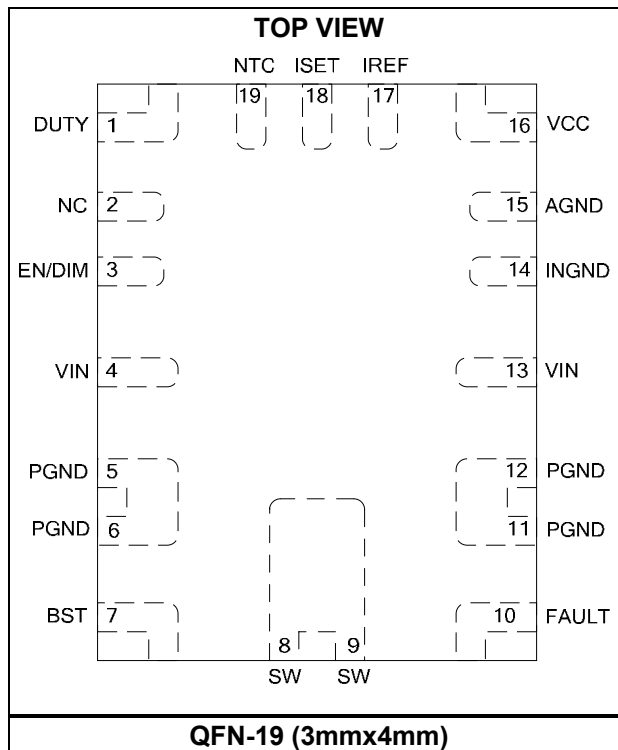

Figure 1: Evaluation Board Schematic

### PACKAGE REFERENCE



**EVQ7200-L-00B BILL OF MATERIALS**

Qty	Designator	Value	Description	Package	Manufacturer	Manufacturer PN
4	CIN1, CIN2, CIN3, CIN4	22nF	Ceramic capacitor, 50V, X7R	0603	Murata	GRM188R71H223KA01D
2	CIN5, CIN6	10 $\mu$ F	Ceramic capacitor, 50V, X7R	1210	Murata	GRM32ER71H106KA8
1	CIN7	47 $\mu$ F	Electrolytic capacitor, 63V	SMD	Panasonic	EEHZC1J470P
2	C1A, C1B	4.7 $\mu$ F	Ceramic capacitor, 50V, X7R	1210	Murata	GRM32ER71H475KA8
4	C1C, C1D, C3C, C3D	0.1 $\mu$ F	Ceramic capacitor, 50V, X7R	0603	Murata	GRM188R71H104KA93D
2	C2A, C2B	4.7 $\mu$ F	Ceramic capacitor, 25V, X7R	1206	TDK	C3216X7R1E475M
2	C3A, C3B	0.47 $\mu$ F	Ceramic capacitor, 50V, X7R	1206	TDK	C3216X7R1H474K
2	C2C, C2D	1nF	Ceramic capacitor, 50V, C0G	0603	Murata	GRM1885C1H02JAC
2	C2E, C2F	10nF	Ceramic capacitor, 25V, X7R	0603	Würth	885012206065
1	C1	10 $\mu$ F	Ceramic capacitor, 10V, X7R	0603	Murata	GRM188Z71A106KA73D
1	C2	0.1 $\mu$ F	Ceramic capacitor, 16V, X7R	0402	Murata	GCM155R71C104KA55D
1	D1	B140	Schottky diode, 40V, 1A	SMA	Diodes, Inc.	B140
1	L1	4.7 $\mu$ H	Inductor, 44.1m $\Omega$ DCR, 4.6A	SMD	Coilcraft	XAL4030-472MEB
1	L2	4.7 $\mu$ H	Inductor, 44.1m $\Omega$ DCR, 4.6A	SMD	Coilcraft	XAL4030-472MEB
1	L3	240nH	Inductor, 27m $\Omega$ DCR, 6.5A	SMD	Cyntec	VCUW20161B-R24MS5
2	R1, R2	100k $\Omega$	Film resistor, 5%	0603	Yageo	RC0603JR-07100KL
1	R3	4.87k $\Omega$	Film resistor, 1%	0603	Yageo	RC0603FR-074K87L
1	R4	10k $\Omega$	Film resistor, 1%	0603	Yageo	RC0603FR-0710KL
1	R7	20 $\Omega$	Film resistor, 1%	0402	Yageo	RC0402FR-0720RL
1	R5	13.3k $\Omega$	Film resistor, 1%	0603	Yageo	RC0603FR-0713K3L
1	R6	2.32k $\Omega$	Film resistor, 1%	0603	Yageo	RC0603FR-072K32L
1	U1	MPQ7200	Step-up/down regulator	QFN-19 (3mmx 4mm)	MPS	MPQ7200GL-AEC1
4	VEMI, GND, VLED+, VLED-		2.0mm golden pin		Custom	
4	EN, GND, FAULT, GND		1.0mm golden pin		Custom	

## EVB TEST RESULTS

Performance curves and waveforms are tested on the evaluation board,  $V_{IN} = 13.5V$ , 4 LEDs ( $V_{LED} = 12V$ ),  $L = 4.7\mu H$ ,  $f_{SW} = 1.15MHz$ ,  $T_A = 25^\circ C$ , buck-boost mode, unless otherwise noted.

**Efficiency vs. Input Voltage vs. Power Loss**

3 LEDs ( $V_{LED} = 9V$ )

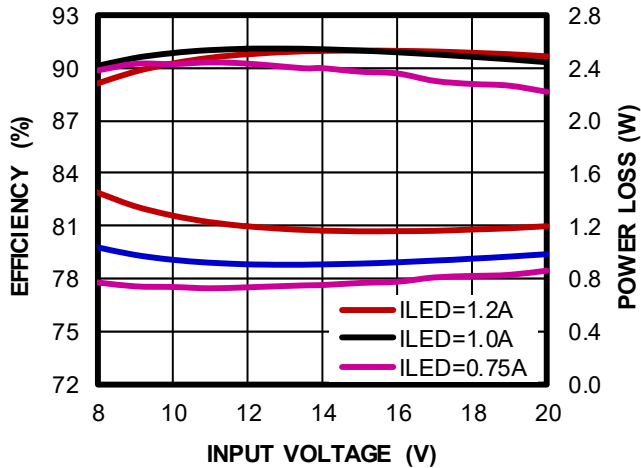

**Efficiency vs. Input Voltage vs. Power Loss**

4 LEDs ( $V_{LED} = 12V$ )

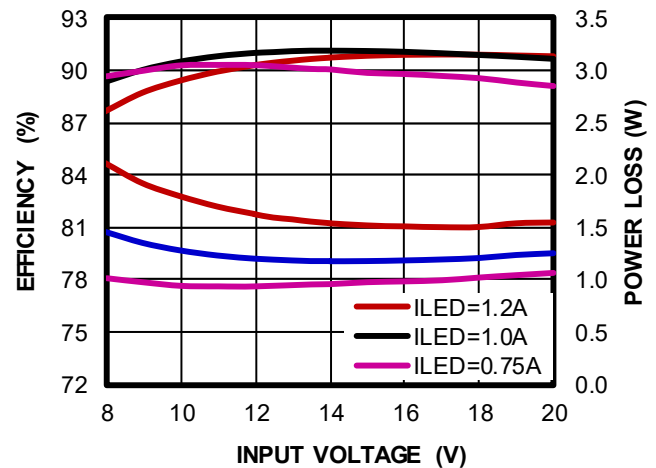

**Case Temperature Rise vs. Input Voltage**

3 LEDs ( $V_{LED} = 9V$ )

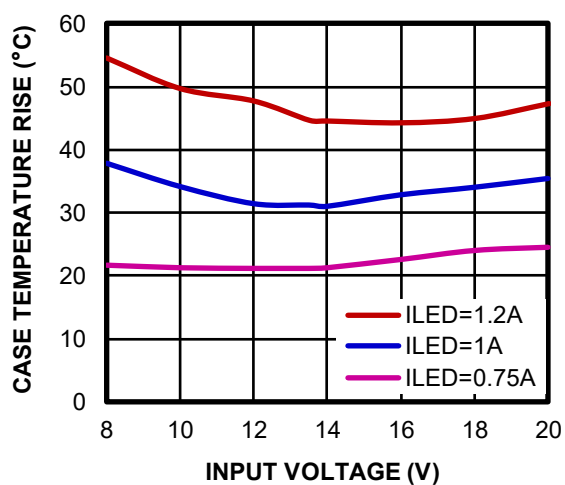

**Case Temperature Rise vs. Input Voltage**

4 LEDs ( $V_{LED} = 12V$ )

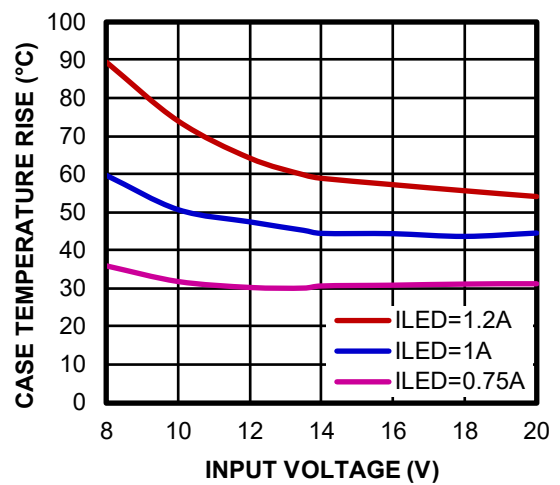

## EVB TEST RESULTS (continued)

Performance curves and waveforms are tested on the evaluation board,  $V_{IN} = 13.5V$ , 4 LEDs ( $V_{LED} = 12V$ ),  $L = 4.7\mu H$ ,  $f_{SW} = 1.15MHz$ ,  $T_A = 25^\circ C$ , buck-boost mode, unless otherwise noted.

### CISPR25 Class 5 Peak Conducted Emissions

150kHz to 108MHz

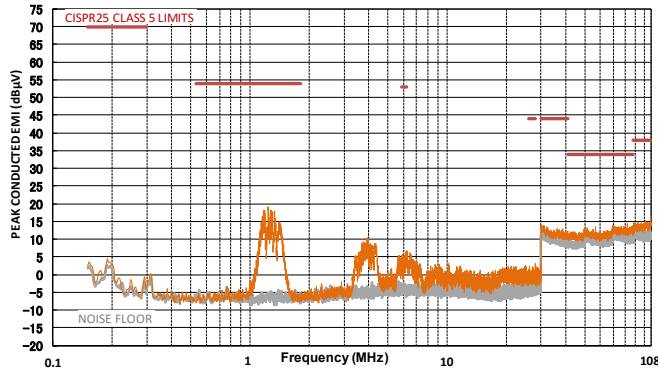

### CISPR25 Class 5 Average Conducted Emissions

150kHz to 108MHz

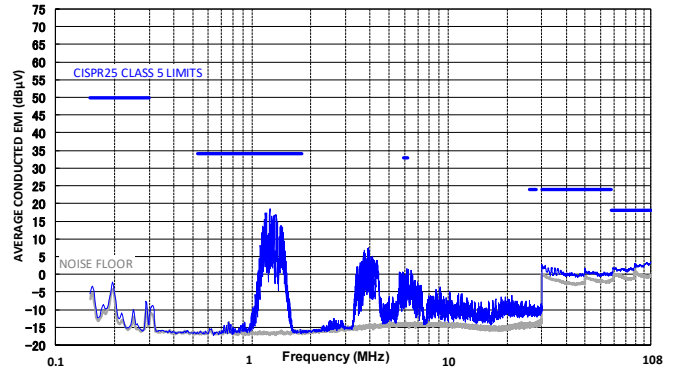

### CISPR25 Class 5 Peak Radiated Emissions

150kHz to 30MHz

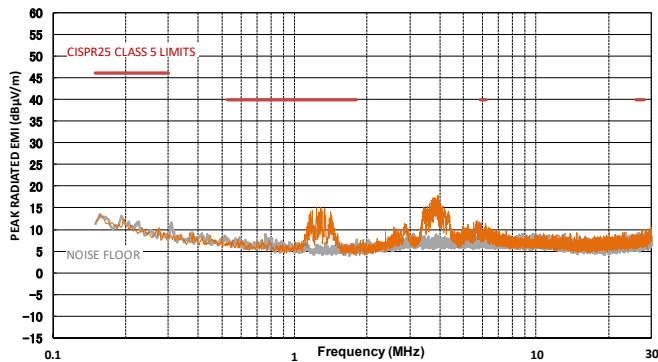

### CISPR25 Class 5 Average Radiated Emissions

150kHz to 30MHz

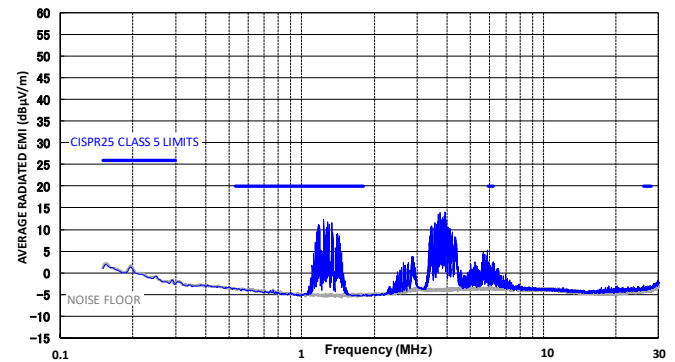

### CISPR25 Class 5 Peak Radiated Emissions

Horizontal, 30MHz to 200MHz

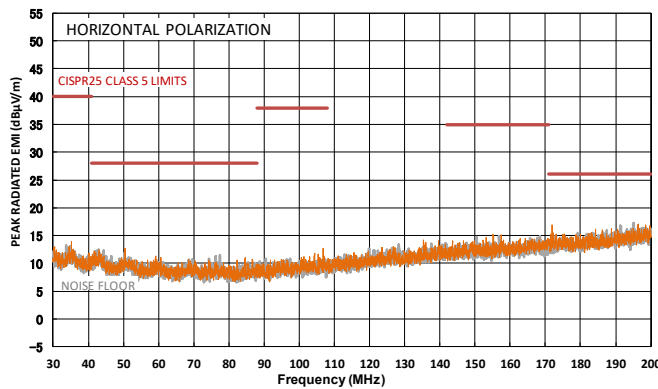

### CISPR25 Class 5 Average Radiated Emissions

Horizontal, 30MHz to 200MHz

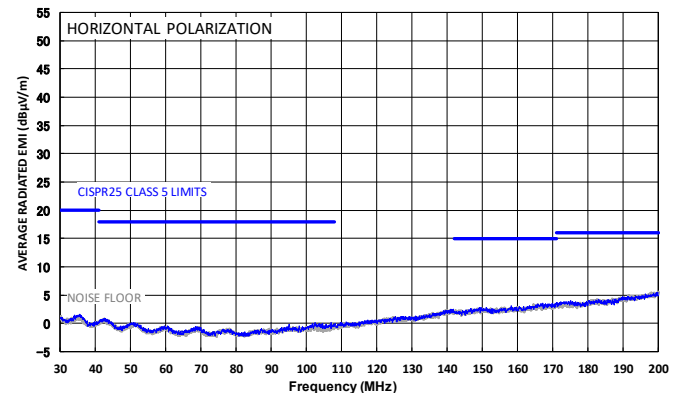

## EVB TEST RESULTS *(continued)*

Performance curves and waveforms are tested on the evaluation board,  $V_{IN} = 13.5V$ , 4 LEDs ( $V_{LED} = 12V$ ),  $L = 4.7\mu H$ ,  $f_{SW} = 1.15MHz$ ,  $T_A = 25^\circ C$ , buck-boost mode, unless otherwise noted.

**CISPR25 Class 5 Peak Radiated Emissions**  
Vertical, 30MHz to 200MHz

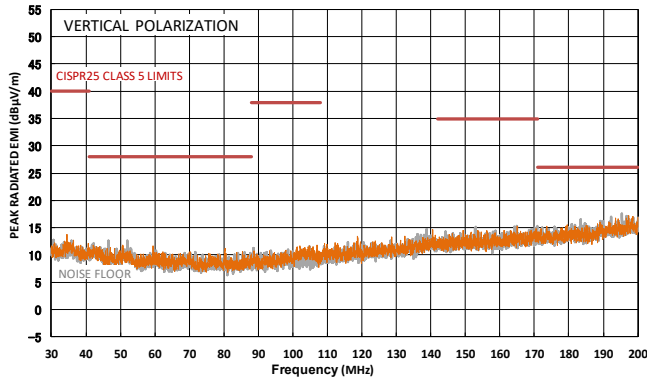

**CISPR25 Class 5 Average Radiated Emissions**  
Vertical, 30MHz to 200MHz

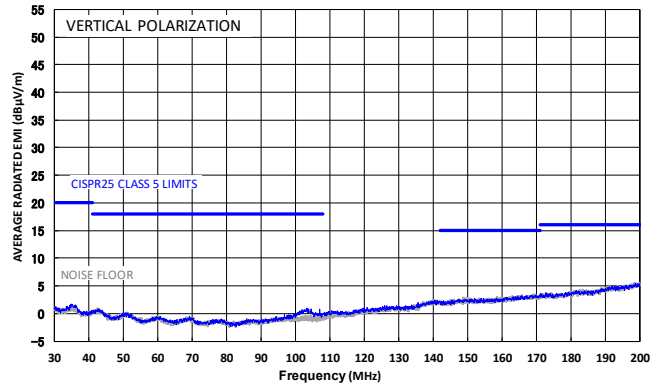

**CISPR25 Class 5 Peak Radiated Emissions**  
Horizontal, 200MHz to 1GHz

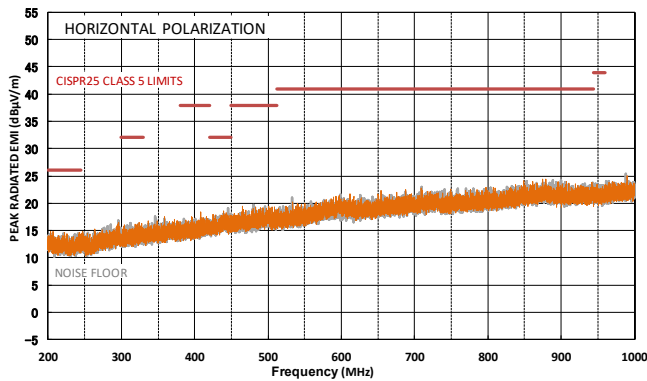

**CISPR25 Class 5 Average Radiated Emissions**  
Horizontal, 200MHz to 1GHz

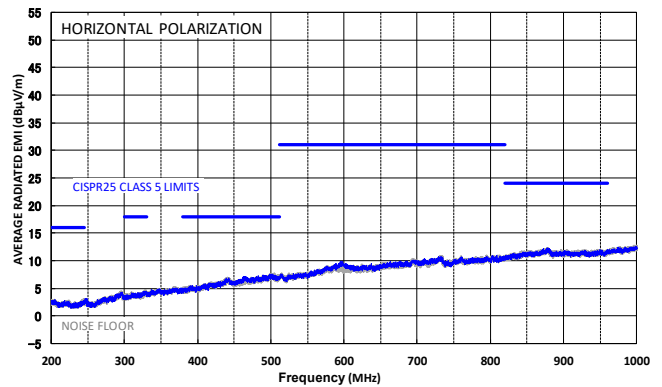

**CISPR25 Class 5 Peak Radiated Emissions**  
Vertical, 200MHz to 1GHz

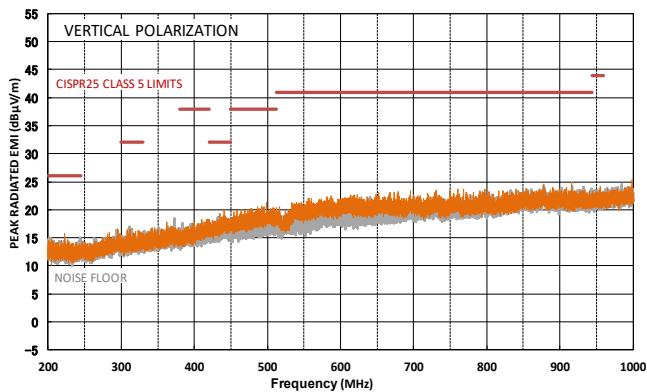

**CISPR25 Class 5 Average Radiated Emissions**  
Vertical, 200MHz to 1GHz

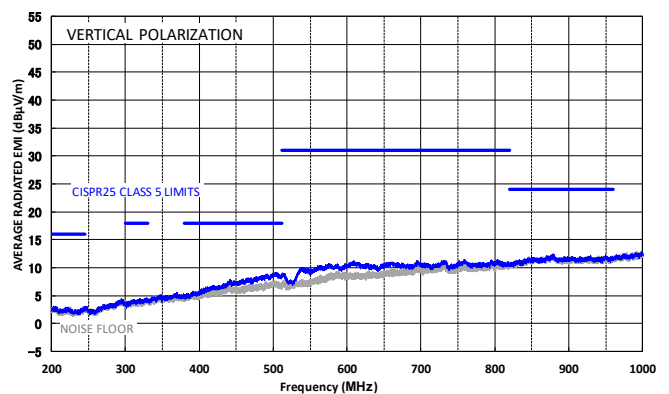



## EVB TEST RESULTS (continued)

Performance curves and waveforms are tested on the evaluation board,  $V_{IN} = 13.5V$ , 4 LEDs ( $V_{LED} = 12V$ ),  $L = 4.7\mu H$ ,  $f_{sw} = 1.15MHz$ ,  $T_A = 25^\circ C$ , buck-boost mode, unless otherwise noted.

### Steady State

$I_{LED} = 1.2A$

CH2:  
 $V_{LED+} - V_{LED-}$   
5V/div.  
CH3:  $I_{LED}$   
500mA/div.  
CH4:  $I_L$   
2A/div.  
CH1:  $V_{sw}$   
10V/div.

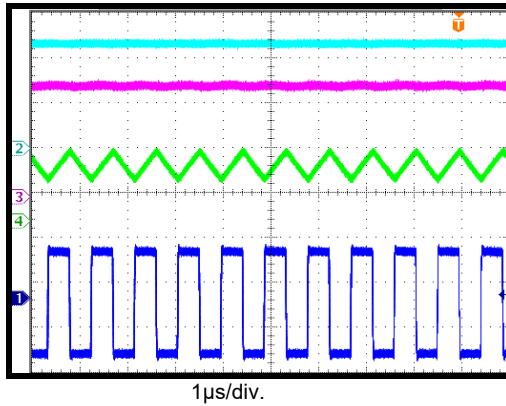

### Start-Up through VIN

$I_{LED} = 1.2A$

R1:  $V_{IN}$   
10V/div.  
CH2:  
 $V_{LED+} - V_{LED-}$   
10V/div.  
CH3:  $I_{LED}$   
1A/div.  
CH4:  $I_L$   
2A/div.  
CH1:  $V_{sw}$   
10V/div.

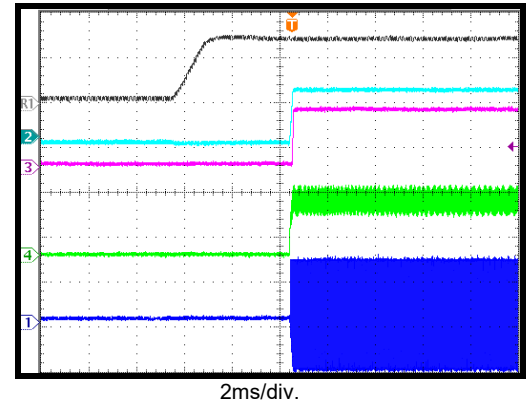

### Shutdown through VIN

$I_{LED} = 1.2A$

R1:  $V_{IN}$   
5V/div.  
CH2:  
 $V_{LED+} - V_{LED-}$   
10V/div.  
CH3:  $I_{LED}$   
1A/div.  
CH4:  $I_L$   
2A/div.  
CH1:  $V_{sw}$   
10V/div.

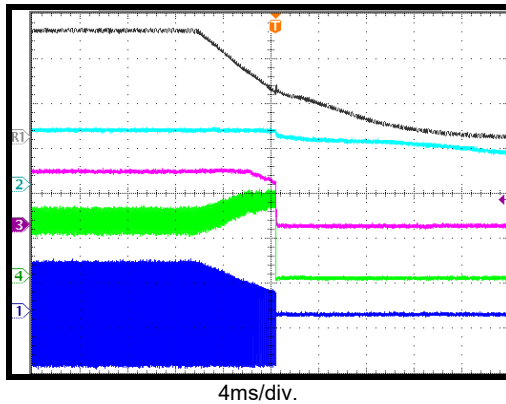

### Start-Up through EN

$I_{LED} = 1.2A$

R1:  $V_{EN/DIM}$   
2V/div.  
CH2:  
 $V_{LED+} - V_{LED-}$   
5V/div.  
CH3:  $I_{LED}$   
1A/div.  
CH4:  $I_L$   
2A/div.  
CH1:  $V_{sw}$   
10V/div.

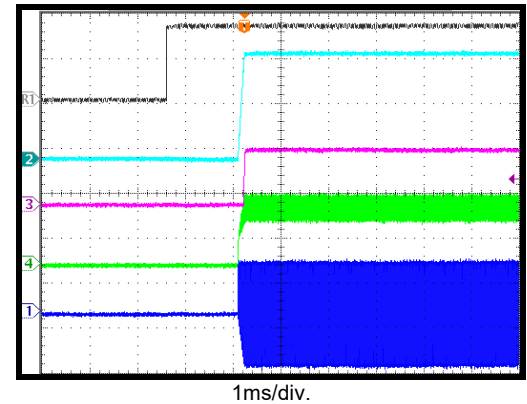

### Shutdown through EN

$I_{LED} = 1.2A$

R1:  $V_{EN/DIM}$   
2V/div.  
CH3:  $I_{LED}$   
1A/div.  
CH2:  
 $V_{LED+} - V_{LED-}$   
5V/div.  
CH4:  $I_L$   
2A/div.  
CH1:  $V_{sw}$   
10V/div.

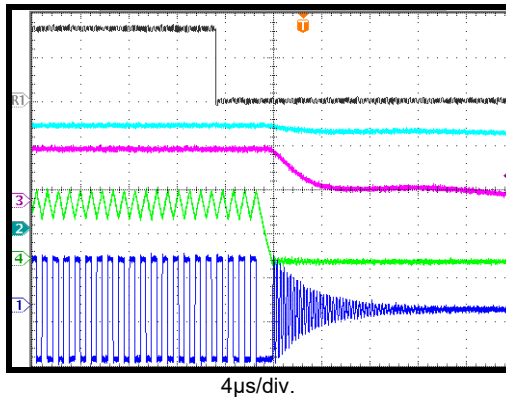

### PWM Dimming Steady State

Dimming frequency = 100Hz

R1:  $V_{FAULT}$   
10V/div.  
CH2:  
 $V_{LED+} - V_{LED-}$   
2V/div.  
CH3:  $I_{LED}$   
1A/div.  
CH4:  $I_L$   
2A/div.  
CH1:  $V_{sw}$   
10V/div.

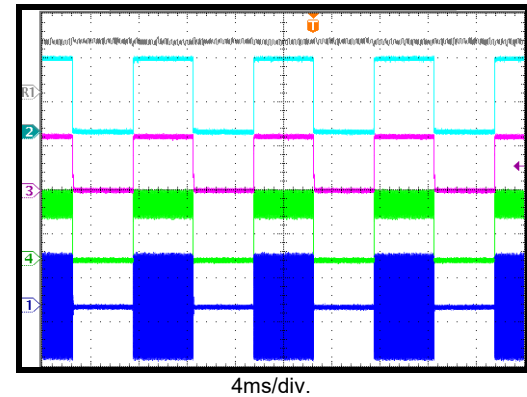

## EVB TEST RESULTS (continued)

Performance curves and waveforms are tested on the evaluation board,  $V_{IN} = 13.5V$ , 4 LEDs ( $V_{LED} = 12V$ ),  $L = 4.7\mu H$ ,  $f_{sw} = 1.15MHz$ ,  $T_A = 25^\circ C$ , buck-boost mode, unless otherwise noted.

**PWM Dimming Steady State**  
Dimming frequency = 500Hz

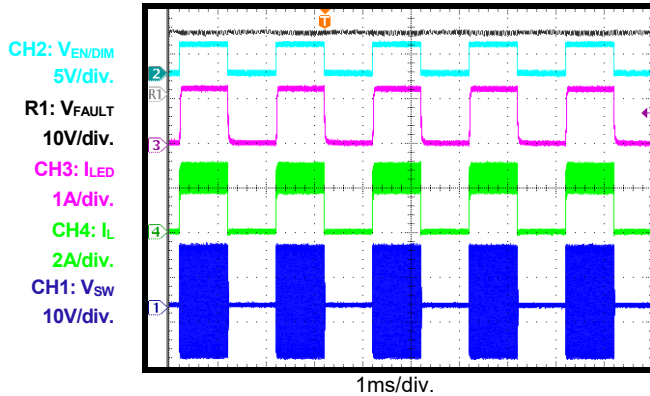

**PWM Dimming**  
Start-Up through  $V_{IN}$

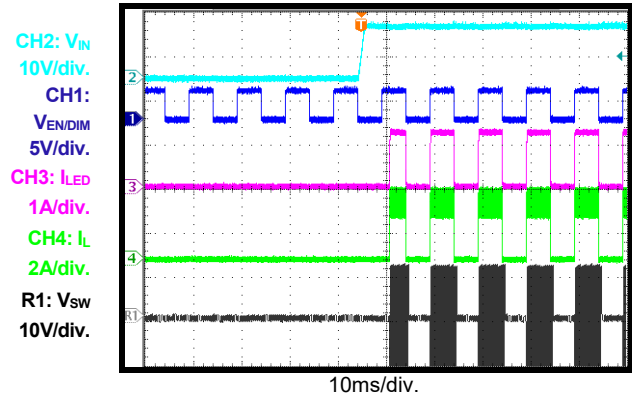

**PWM Dimming**  
Shutdown through  $V_{IN}$

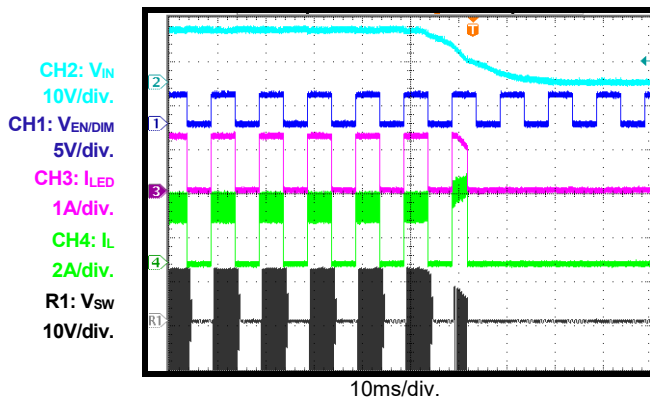

**Two-Step Dimming**  
Steady state

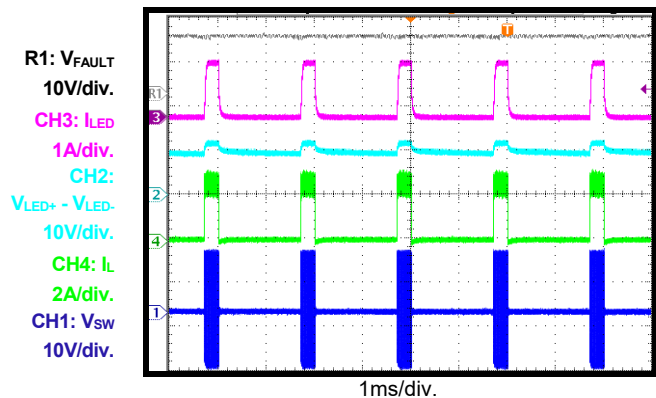

**Two-Step Dimming**  
Start-Up through  $V_{IN}$

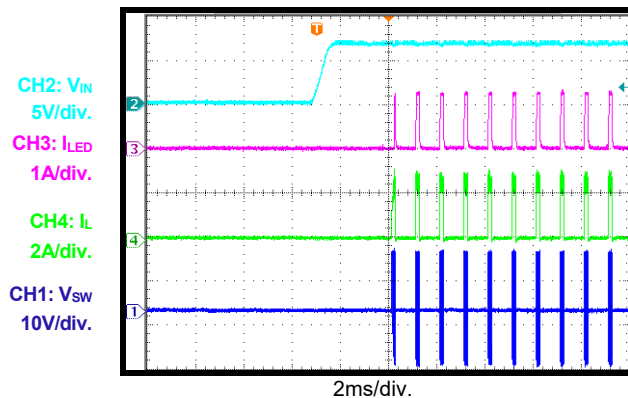

**Two-Step Dimming**  
Shutdown through  $V_{IN}$

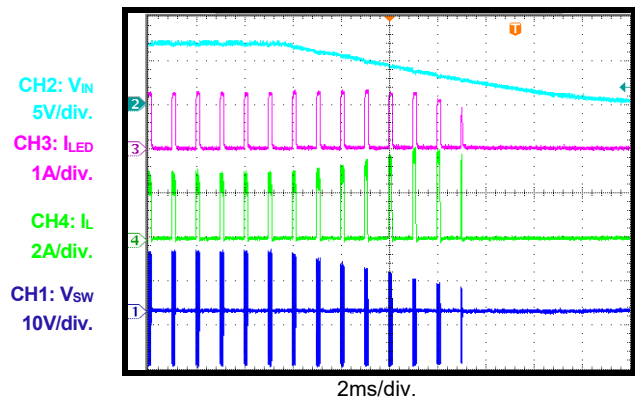

## EVB TEST RESULTS (continued)

Performance curves and waveforms are tested on the evaluation board,  $V_{IN} = 13.5V$ , 4 LEDs ( $V_{LED} = 12V$ ),  $L = 4.7\mu H$ ,  $f_{sw} = 1.15MHz$ ,  $T_A = 25^\circ C$ , buck-boost mode, unless otherwise noted.

**No Dimming**  
LED open, start-up through VIN

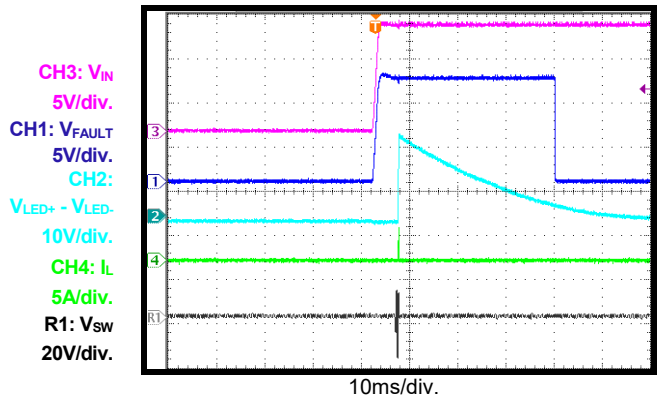

**No Dimming**  
LED open entry

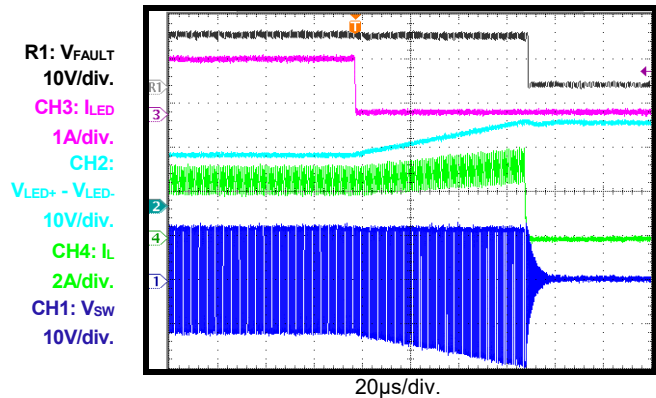

**PWM Dimming**  
LED open, start-up through VIN

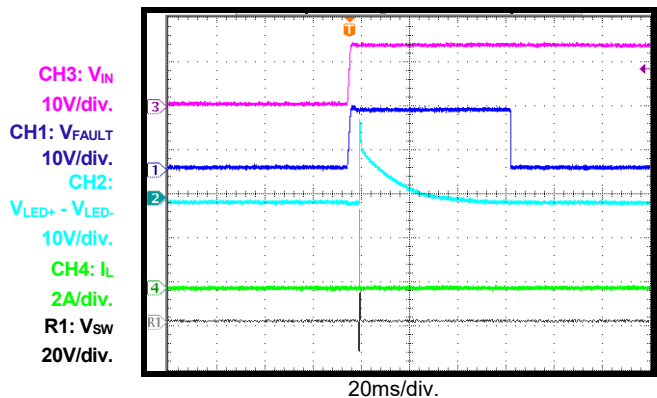

**PWM Dimming**  
LED open entry

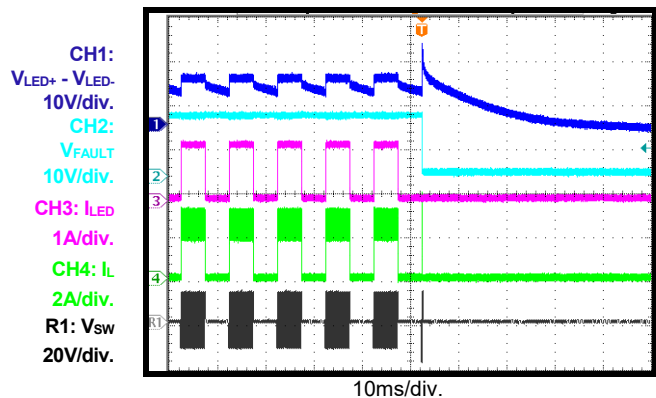

**Two-Step Dimming**  
LED open, start-up through VIN

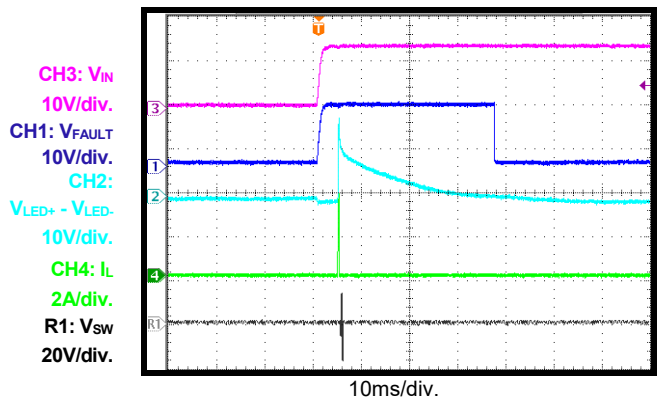

**Two-Step Dimming**  
LED open entry

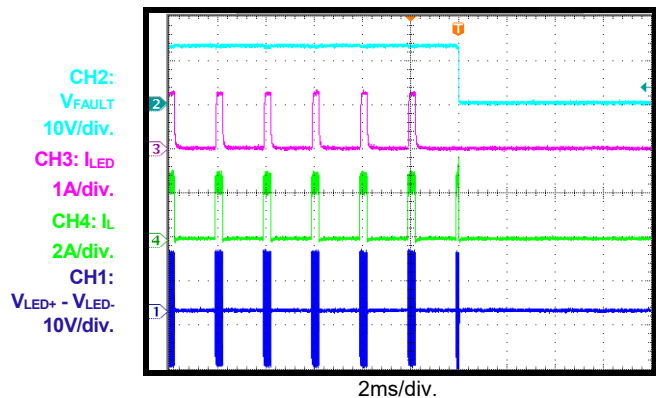

## EVB TEST RESULTS (continued)

Performance curves and waveforms are tested on the evaluation board,  $V_{IN} = 13.5V$ , 4 LEDs ( $V_{LED} = 12V$ ),  $L = 4.7\mu H$ ,  $f_{sw} = 1.15MHz$ ,  $T_A = 25^\circ C$ , buck-boost mode, unless otherwise noted.

### No Dimming

LED+ Short to LED-, start-up through VIN

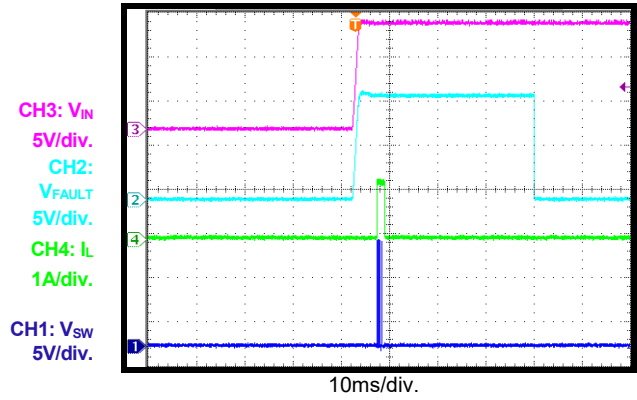

### No Dimming

LED+ short to LED- entry

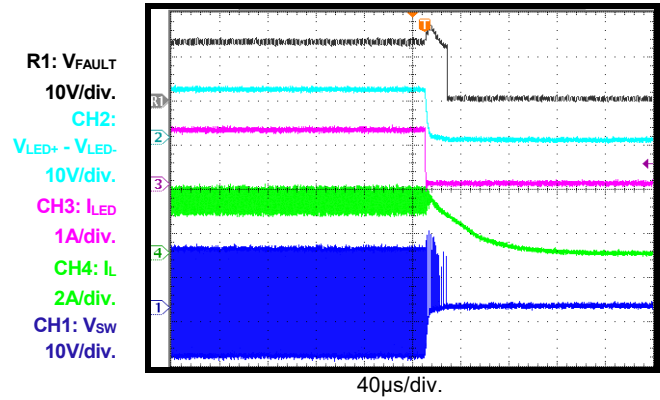

### PWM Dimming

LED+ Short to LED-, start-up through VIN

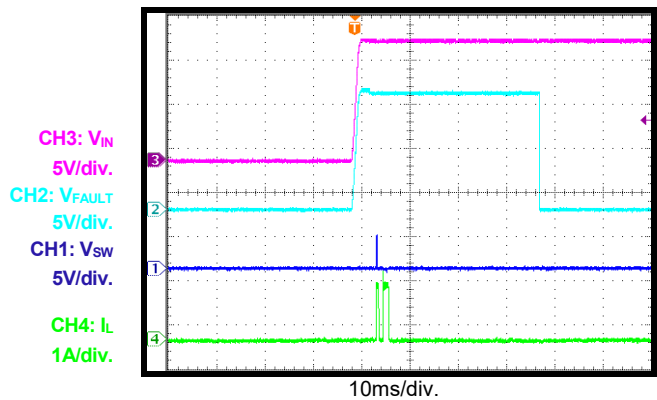

### PWM Dimming

LED+ short to LED- entry

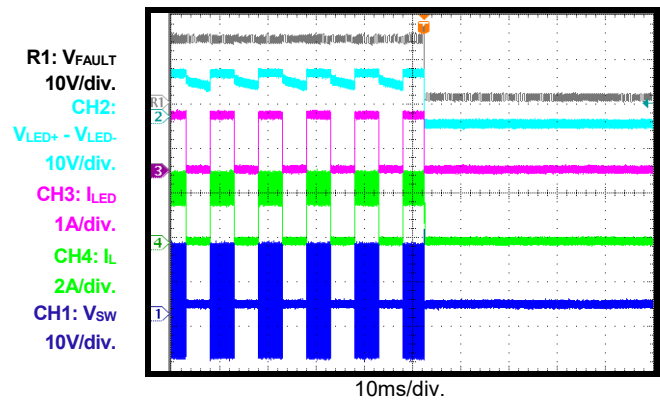

### Two-Step Dimming

LED+ Short to LED-, start-up through VIN

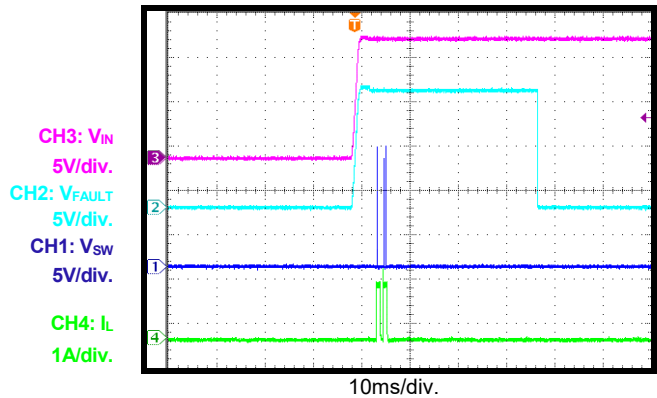

### Two-Step Dimming

LED+ short to LED- entry

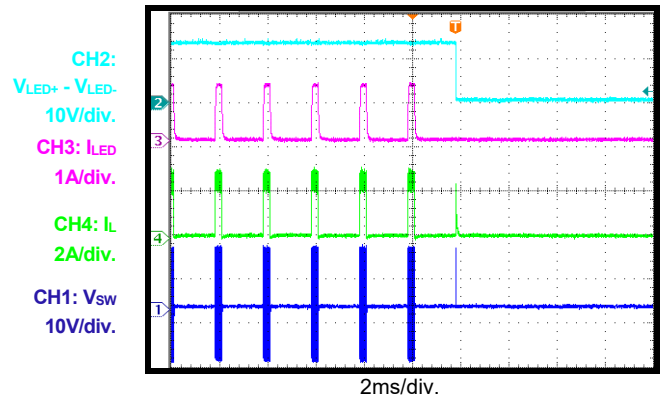

## EVB TEST RESULTS *(continued)*

Performance curves and waveforms are tested on the evaluation board,  $V_{IN} = 13.5V$ , 4 LEDs ( $V_{LED} = 12V$ ),  $L = 4.7\mu H$ ,  $f_{sw} = 1.15MHz$ ,  $T_A = 25^\circ C$ , buck-boost mode, unless otherwise noted.

**$I_{REF}$  Short before VIN Start-Up**

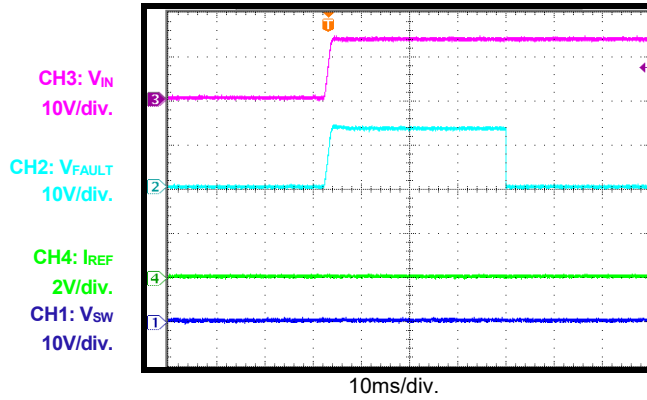

**$I_{REF}$  Open before VIN Start-Up**

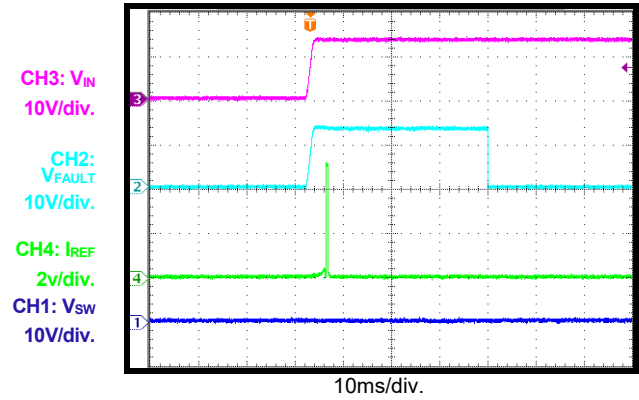

**$I_{REF}$  Short after VIN Start-Up**

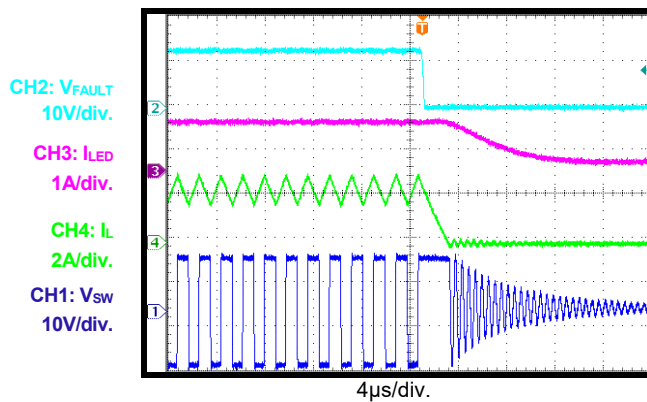

**$I_{REF}$  Open after VIN Start-Up**

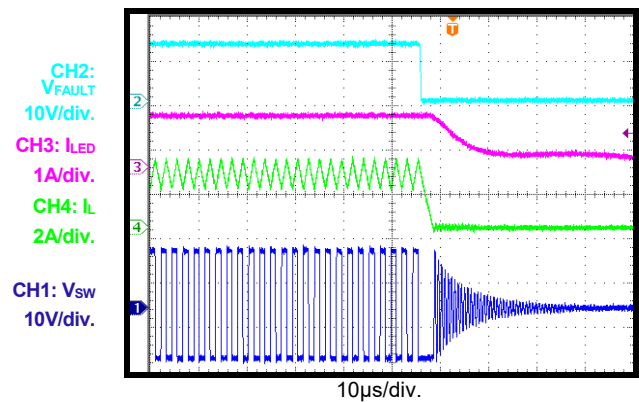

**$I_{SET}$  Short before VIN Start-Up**

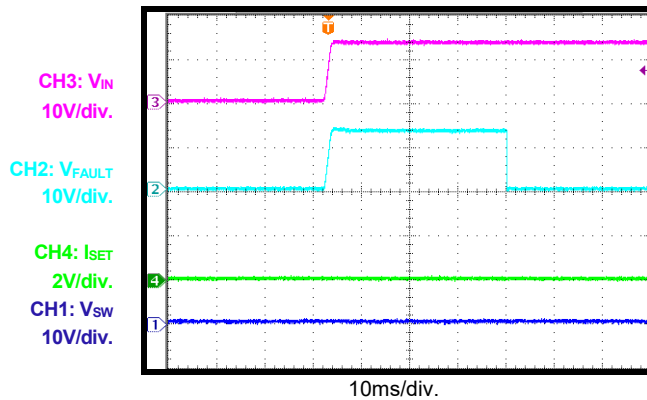

**$I_{SET}$  Open before VIN Start-Up**

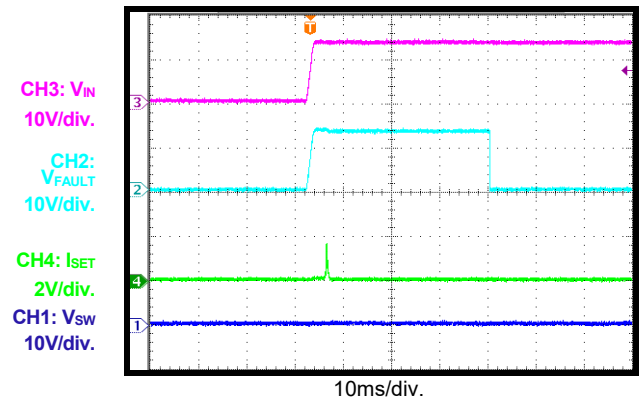

## EVB TEST RESULTS (continued)

Performance curves and waveforms are tested on the evaluation board,  $V_{IN} = 13.5V$ , 4 LEDs ( $V_{LED} = 12V$ ),  $L = 4.7\mu H$ ,  $f_{sw} = 1.15MHz$ ,  $T_A = 25^\circ C$ , buck-boost mode, unless otherwise noted.

### $I_{SET}$ Short after VIN Start-Up

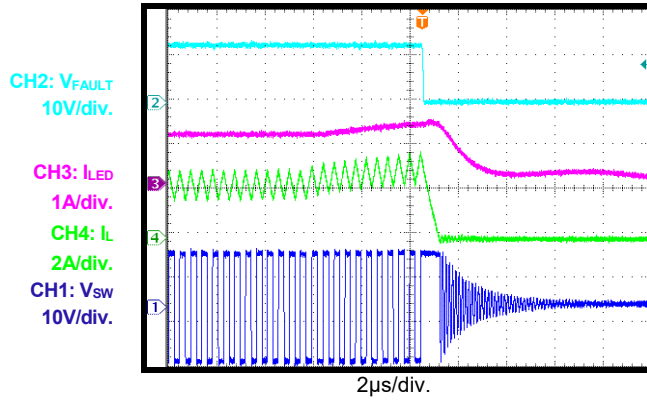

### $I_{SET}$ Open after VIN Start-Up

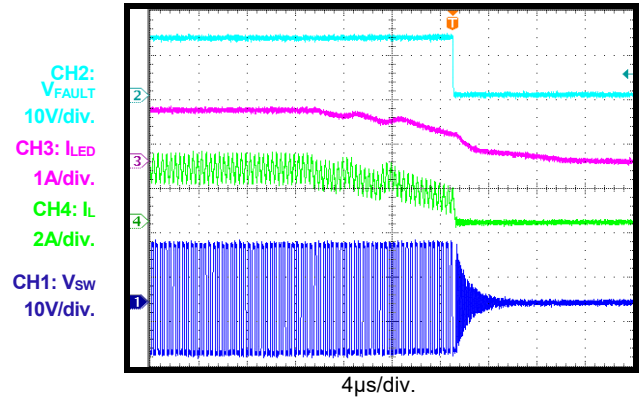

### $I_{DUTY}$ Short before VIN Start-Up

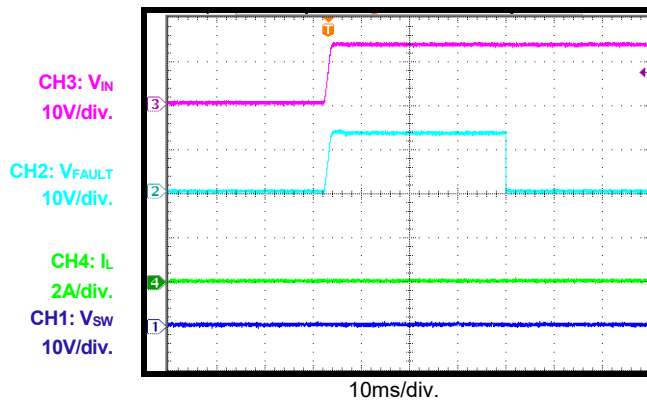

### $I_{DUTY}$ Open before VIN Start-Up

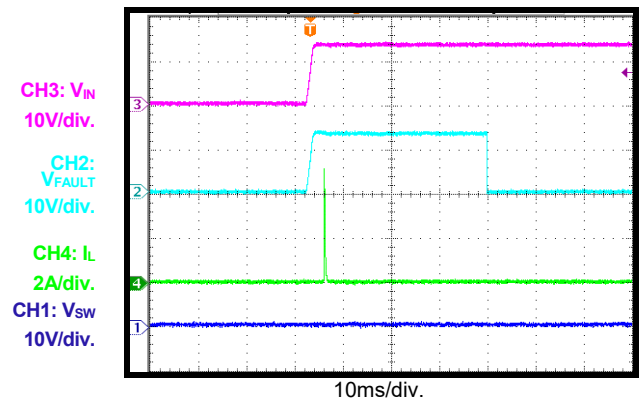

### Mode Detect Wrong at VIN Start-Up

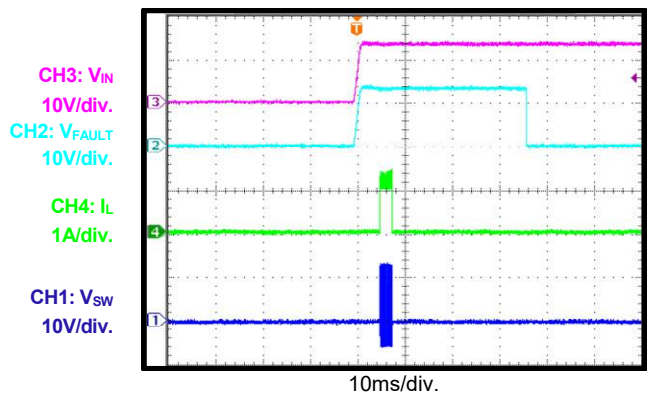

### PCB LAYOUT

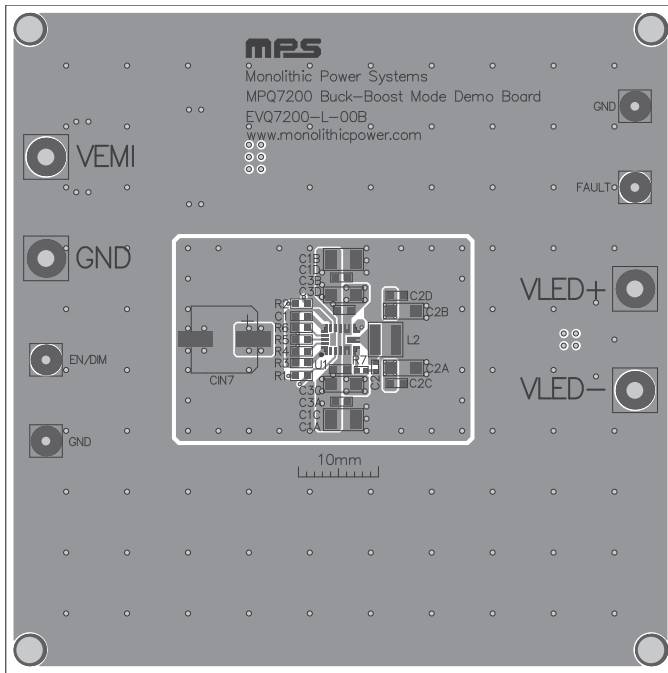

Figure 2: Top Silk and Top Layer

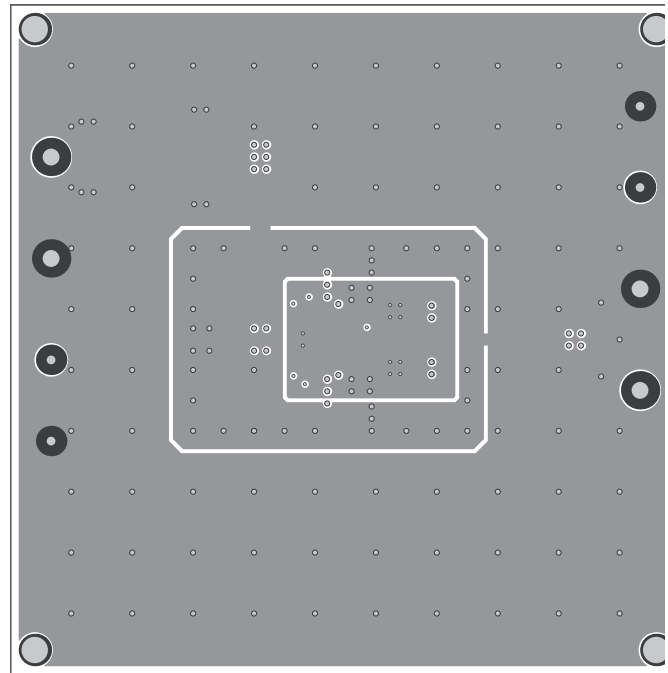

Figure 3: Mid-Layer 1

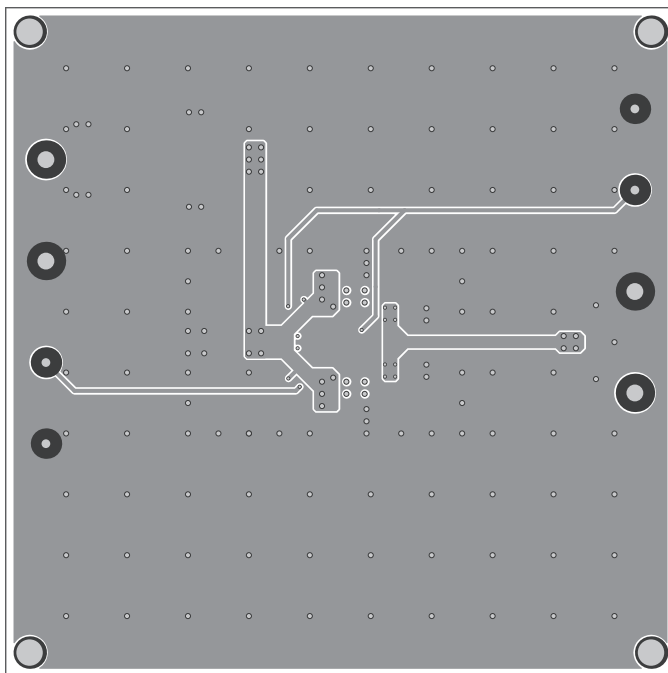

Figure 4: Mid-Layer 2

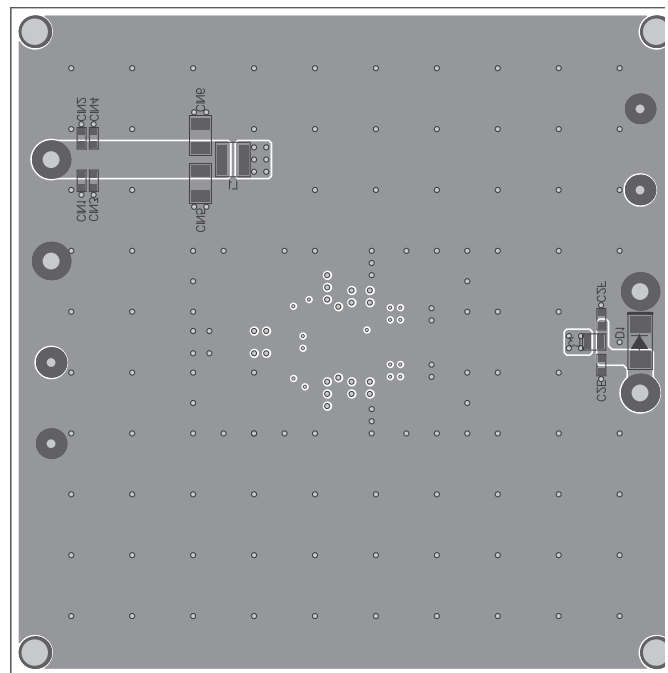

Figure 5: Bottom Layer and Bottom Silk

## REVISION HISTORY

Revision #	Revision Date	Description	Pages Updated
1.0	2/23/2021	Initial Release	-

**Notice:** The information in this document is subject to change without notice. Please contact MPS for current specifications. Users should warrant and guarantee that third-party Intellectual Property rights are not infringed upon when integrating MPS products into any application. MPS will not assume any legal responsibility for any said applications.