



OEG Miniature Relay PCF

TE Internal #: 5558503-1

RJ45 Connectors, RJ45, Multiple Ports, 1 x 4, RJ Type Jacks & Plugs, Standard Connector Contact Density, Jack, Shielded, OEG Miniature Relay PCF

[View on TE.com >](#)

Connectors > Modular Jacks & Plugs > RJ45 Connectors

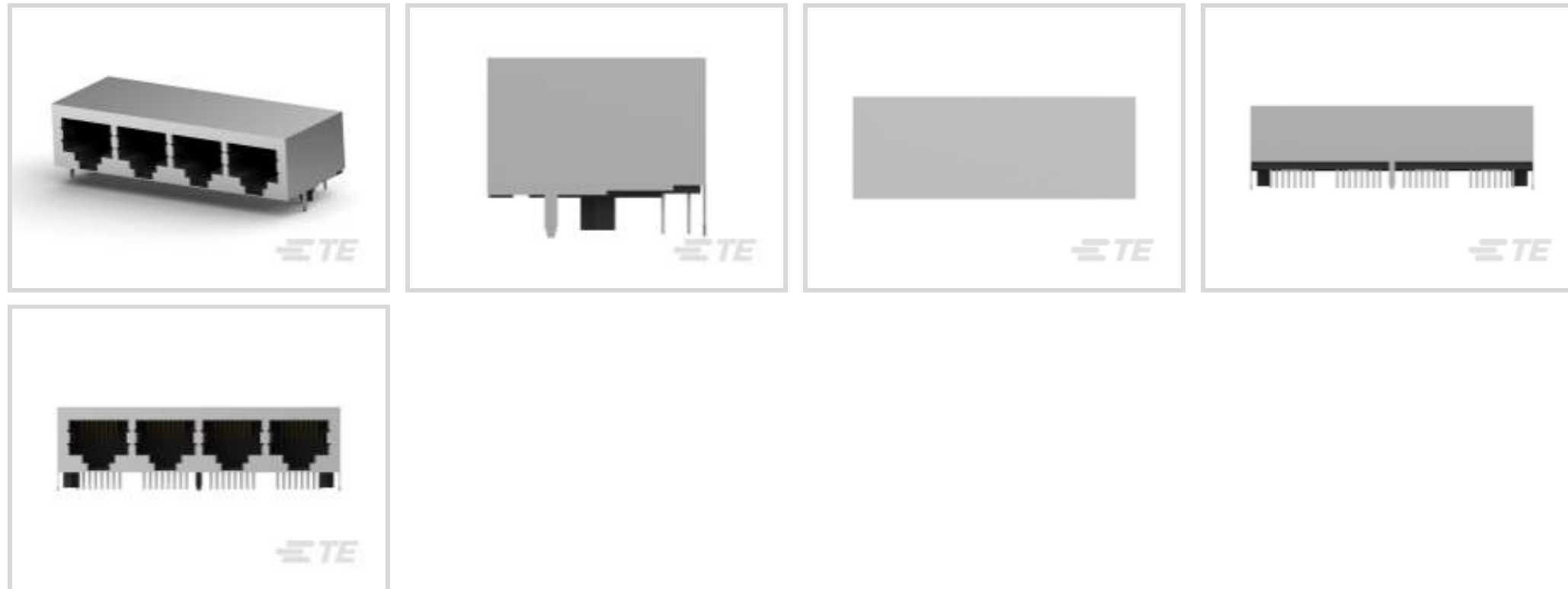

Modular Jack & Plug Interface Type: **RJ45**

Port Configuration: **Multiple Ports**

Port Matrix Configuration: **1 x 4**

Modular Jacks & Plugs Products: **RJ Type Jacks & Plugs**

Connector Contact Density: **Standard**

Features

Product Type Features

Connector Product Type	Connector Assembly
Modular Jack & Plug Interface Type	RJ45
Modular Jacks & Plugs Products	RJ Type Jacks & Plugs
Modular Connector Style	Jack
Grounding Options	PCB Ground
Connector & Contact Terminates To	Printed Circuit Board

Configuration Features

Status Indicator Type	None
Number of PCB Ground Tabs	3
Multiple Port Configuration	Ganged
Port Configuration	Multiple Ports
Port Matrix Configuration	1 x 4
Connector Contact Density	Standard
Number of Positions	8



Number of Loaded Positions	8
----------------------------	---

PCB Mount Orientation	Right Angle
-----------------------	-------------

Body Features

PCB Ground Tab Location	4.57 mm[.18 in]
-------------------------	-----------------

Shield Plating Material	Tin over Copper
-------------------------	-----------------

Shield Material	Copper Zinc Alloy
-----------------	-------------------

Modular Jack Latch Orientation	Standard - Latch Down
--------------------------------	-----------------------

Connector Profile	Standard
-------------------	----------

Contact Features

Contact Underplating Material	Nickel
-------------------------------	--------

PCB Contact Termination Area Plating Material	Tin
---	-----

Contact Current Rating (Max)	.2 A, 1.5 A
------------------------------	-------------

Contact Mating Area Plating Material	Gold
--------------------------------------	------

Contact Base Material	Phosphor Bronze
-----------------------	-----------------

Contact Mating Area Plating Material Thickness	1.27 μ m[50 μ in]
--	---------------------------

Termination Features

Termination Method to Printed Circuit Board	Through Hole - Solder
---	-----------------------

Termination Post & Tail Length	3.56 mm[.14 in]
--------------------------------	-----------------

Mechanical Attachment

Panel Mount Feature	Without
---------------------	---------

Connector Mounting Type	Board Mount
-------------------------	-------------

Housing Features

Mating Entry Location	Side
-----------------------	------

Centerline (Pitch)	1.02 mm[.04 in]
--------------------	-----------------

Housing Color	Black
---------------	-------

Housing Material	High Temperature Nylon
------------------	------------------------

Dimensions

Connector Height	13.64 mm[.537 in]
------------------	-------------------

Usage Conditions

Operating Temperature Range	-40 – 85 °C[-40 – 185 °F]
-----------------------------	---------------------------

Operation/Application

Shielded	Yes
----------	-----



Circuit Application	Signal
---------------------	--------

Industry Standards

UL Flammability Rating	UL 94V-0
Performance Category	Cat 5e

Packaging Features

Packaging Quantity	20
Packaging Method	Box & Tray, Tray

Product Compliance

[For compliance documentation, visit the product page on TE.com>](#)

EU RoHS Directive 2011/65/EU	Compliant
EU ELV Directive 2000/53/EC	Compliant
China RoHS 2 Directive MIIT Order No 32, 2016	No Restricted Materials Above Threshold
EU REACH Regulation (EC) No. 1907/2006	Current ECHA Candidate List: JUNE 2023 (235) Candidate List Declared Against: JUL 2021 (219) Does not contain REACH SVHC
Halogen Content	Not Low Halogen - contains Br or Cl > 900 ppm.
Solder Process Capability	Wave solder capable to 265°C

Product Compliance Disclaimer

This information is provided based on reasonable inquiry of our suppliers and represents our current actual knowledge based on the information they provided. This information is subject to change. The part numbers that TE has identified as EU RoHS compliant have a maximum concentration of 0.1% by weight in homogenous materials for lead, hexavalent chromium, mercury, PBB, PBDE, DBP, BBP, DEHP, DIBP, and 0.01% for cadmium, or qualify for an exemption to these limits as defined in the Annexes of Directive 2011/65/EU (RoHS2). Finished electrical and electronic equipment products will be CE marked as required by Directive 2011/65/EU. Components may not be CE marked. Additionally, the part numbers that TE has identified as EU ELV compliant have a maximum concentration of 0.1% by weight in homogenous materials for lead, hexavalent chromium, and mercury, and 0.01% for cadmium, or qualify for an exemption to these limits as defined in the Annexes of Directive 2000/53/EC (ELV). Regarding the REACH Regulation, the information TE provides on SVHC in articles for this part number is based on the latest European Chemicals Agency (ECHA) 'Guidance on requirements for substances in articles' posted at this URL: <https://echa.europa.eu/guidance-documents/guidance-on-reach>

Compatible Parts

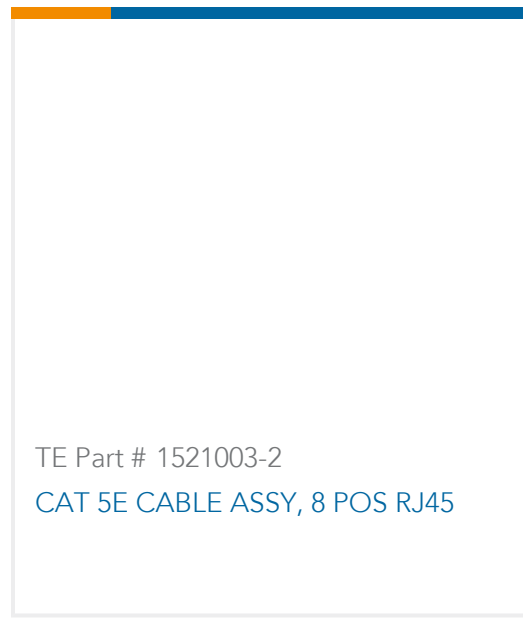
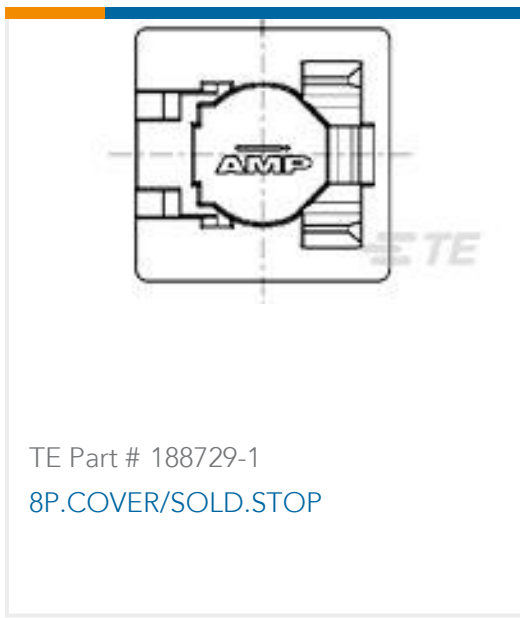

Also in the Series | OEG Miniature Relay PCF

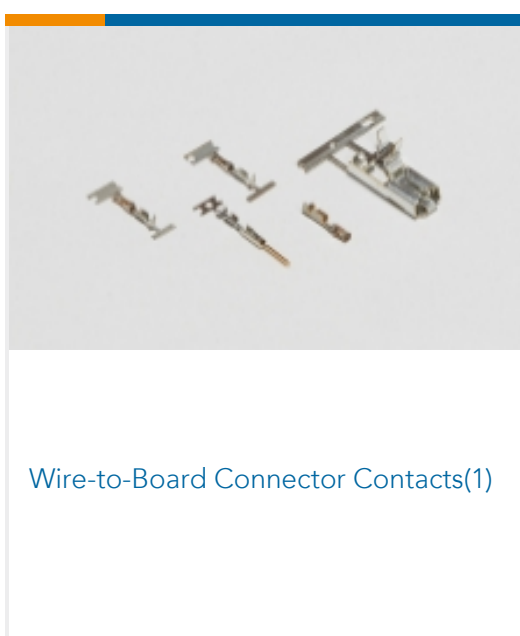
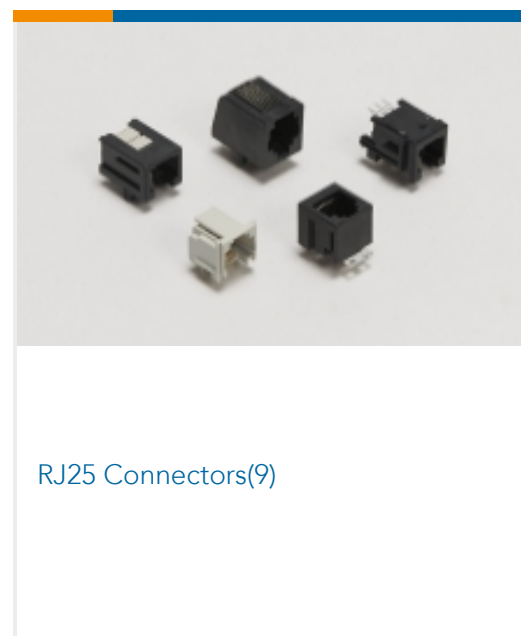
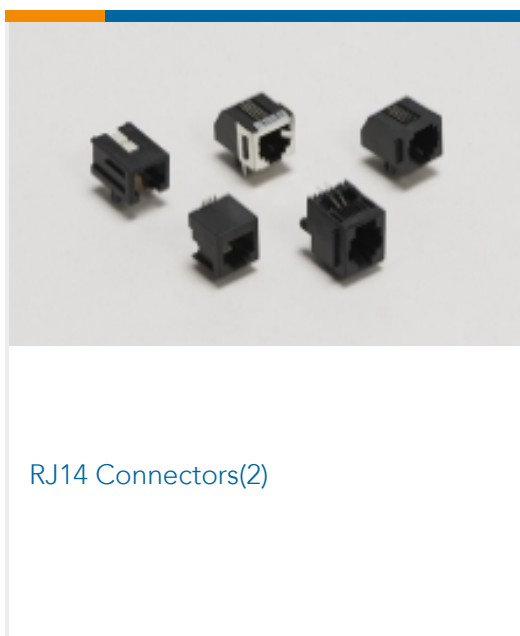
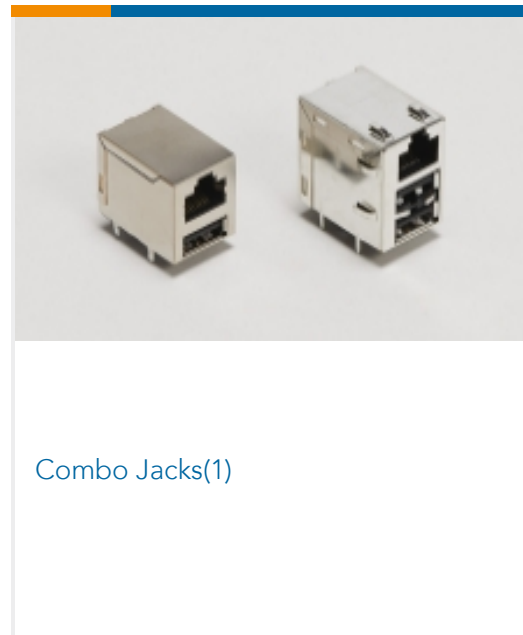
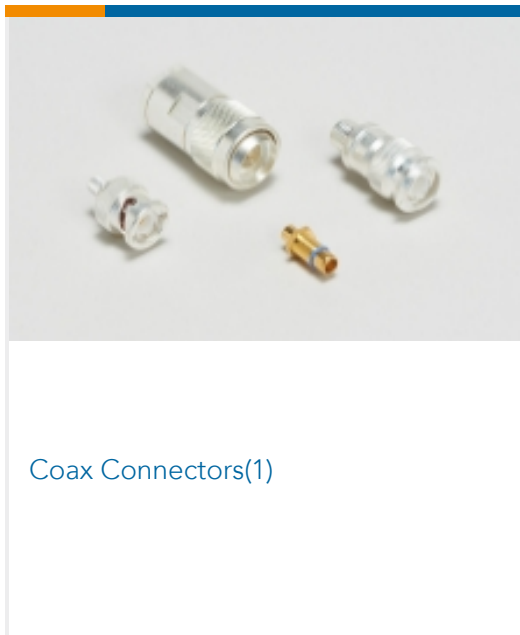

Customers Also Bought

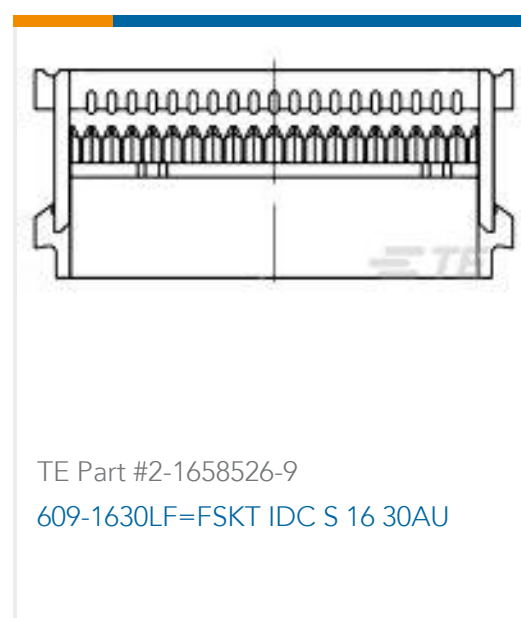



TE Part #2007181-1
SFP+ 1x2 Cage Assy, EMI Gasket



TE Part #1-1825058-9
ADE08S04=DIP SWITCH,EXT,SMT-GW



TE Part #2102061-4
Mezalok, Socket, 114 p, 12 mm, 50 Au, LF



TE Part #2129320-3
Mini Displayport Reverse Offset

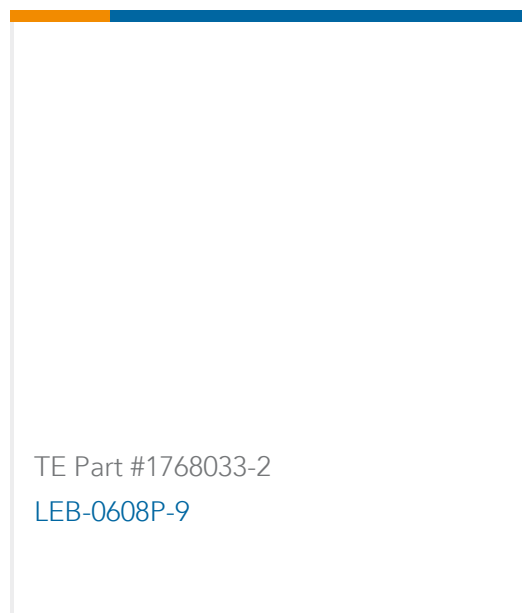

TE Part #1768033-2
LEB-0608P-9

Documents

Product Drawings

[MJ ASSY,4P,8 POS,CAT 5E,PCB GND](#)

English

CAD Files

[3D PDF](#)

3D

Customer View Model

[ENG_CVM_CVM_5558503-1_A_c-5558503-1-a.2d_dxf.zip](#)

English

Customer View Model

[ENG_CVM_CVM_5558503-1_A_c-5558503-1-a.3d_igs.zip](#)

English

Customer View Model

[ENG_CVM_CVM_5558503-1_A_c-5558503-1-a.3d_stp.zip](#)

English

By downloading the CAD file I accept and agree to the [Terms and Conditions](#) of use.

Datasheets & Catalog Pages

[82066 - Modular Jacks and MRJ21 Product catalog - Multi-Port Modular Jacks section](#)

English

Product Specifications

[Application Specification](#)

English

Product Environmental Compliance

[MD_5558503-1_0427201208](#)

5558503-1

RJ45 Connectors, RJ45, Multiple Ports, 1 x 4, RJ Type Jacks & Plugs, Standard Connector Contact Density, Jack, Shielded, OEG Miniature Relay PCF



English

[MD_5558503-1_0427201208](#)

English