

Features

Power Module

- 20W buck/boost converter with up to 4A output
- Input voltage can be higher, lower or same as output voltage
- >90% efficiency from 100mA – 3000mA load
- 7µA standby power consumption
- Low profile, thermally enhanced 25pad LGA package



RBB10-2.0

2 Amp Single Output

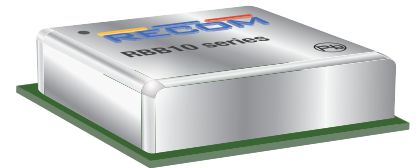

Description

The RBB10-2.0 series is a 4A non-isolated buck/boost regulator power module where the input voltage can be higher, lower or same as output voltage. Transition from buck to boost mode is smooth without any interruption to the output. The compact DOSA-compatible footprint module has a low profile of only 3.75mm, but with an efficiency of up to 95%, the RBB10-2.0 can operate at full load in ambient temperatures as high as 85°C without forced air cooling. The package has 6-sided shielding for optimal EMC performance and excellent thermal management. Typical applications include USB voltage regenerators, 3.3V<->5V converters and supercapacitor or Li-Ion battery regulators.

Selection Guide

| Part Number | Input Voltage Range [VDC] | Nom. Output Voltage [VDC] | Output Current max. [A] | Efficiency typ. [%] | Max. Capacitive Load ⁽¹⁾ [µF] |
|-------------|---------------------------|---------------------------|-------------------------|---------------------|--|
| RBB10-2.0 | 2.3 - 5.5 | 5 (1.0 - 5.5) | 4 | 96 | 42000 |

Notes:

Note1: Max. Cap Load is tested at nominal input and full resistive load

Model Numbering

RBB10-2.0- _____ Packaging ⁽²⁾

Notes:

Note2: add suffix "-CT" for tube packaging for more details refer to "PACKAGING INFORMATION" without suffix, standard tape and reel packaging



EN55032 compliant

Specifications (measured @ Ta= 25°C, 5Vin, 5Vout, 2A and after warm-up unless otherwise stated)

| BASIC CHARACTERISTICS | | | | | |
|--|------------------------------|-------------|-----------|---------|--------|
| Parameter | Condition | | Min. | Typ. | Max. |
| Internal Input Filter | | | capacitor | | |
| Input Voltage Range ⁽³⁾ | | | 2.3VDC | 5VDC | 5.5VDC |
| Absolute Maximum Input Voltage | | | 7VDC | | |
| Undervoltage Lockout Threshold | | | 1.6VDC | 1.75VDC | 2.0VDC |
| Undervoltage Lockout Hysteresis | | | 65mV | | |
| Input Current | Vin= 5VDC | | | 2.3A | |
| | Vin= 3.6VDC | | | 3.4A | |
| Quiescent Current | Vin= 5VDC | | | 40µA | 90µA |
| Internal Power Dissipation | Vin= 5VDC | | | | 0.9W |
| | Vin= 3.6VDC | | | | 1.8W |
| Output Current Range | refer to safe operating area | | 0A | | 4A |
| Output Voltage Trimming ⁽⁴⁾ | see table or calculation | | 1.0VDC | 5.0VDC | 5.5VDC |
| Minimum Load | | | 0% | | |
| Start-up time | power up 2A | Vin= 5VDC | | 1.4ms | |
| | | Vin= 3.6VDC | | 1.8ms | |
| | BUCK | Vin= 5VDC | | 700µs | |
| | BOOST | Vin= 3.6VDC | | 450µs | |

continued on next page



<https://recom-power.com/rec-s-RBB10-2.0-EVM-1.html>

Specifications (measured @ Ta= 25°C, 5Vin, 5Vout, 2A and after warm-up unless otherwise stated)

| Parameter | Condition | | Min. | Typ. | Max. |
|--|--------------------------------|--------------------------|--|---------|---------|
| Rise Time | | | | 400µs | |
| ON/OFF CTRL | nom. Vin= 5VDC | DC-DC ON DC-DC OFF | Open or $1.2V < V_{CTRL} < V_{in}$ Short or $-0.3V < V_{CTRL} < 0.4VDC$ | | |
| Input Current of CTRL Pad | nom. Vin= 5VDC | CTRL voltage = 0V | | 5µA | |
| Standby Current | nom. Vin= 5VDC | CTRL voltage = 0V | | 5.1µA | 7µA |
| Internal Operating Frequency | | | | 2.55MHz | |
| Output Ripple and Noise ⁽⁵⁾ | 20MHz BW - 98Ω @ 100MHz + 22µF | | | 15mVp-p | |
| Absolute Maximum Capacitive Load | <1 second start up | C _{ss} = 3700nF | | | 42000µF |
| | <1 second start up | no C _{ss} | | | 800µF |

Notes:

- Note3: For detail information please refer to "Safe Operating Area" graph below
- Note4: For detail information please refer to trim table or calculation on page RBB-3
- Note5: Measurements are made with a 22µF MLCC across output (low ESR)

Efficiency vs. Load

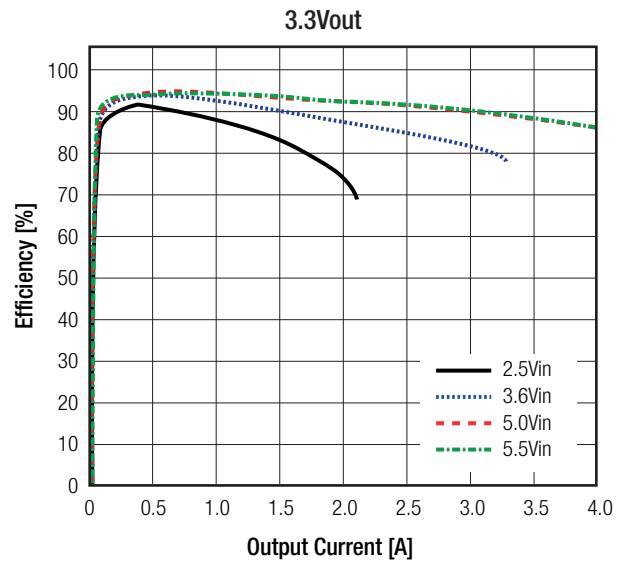
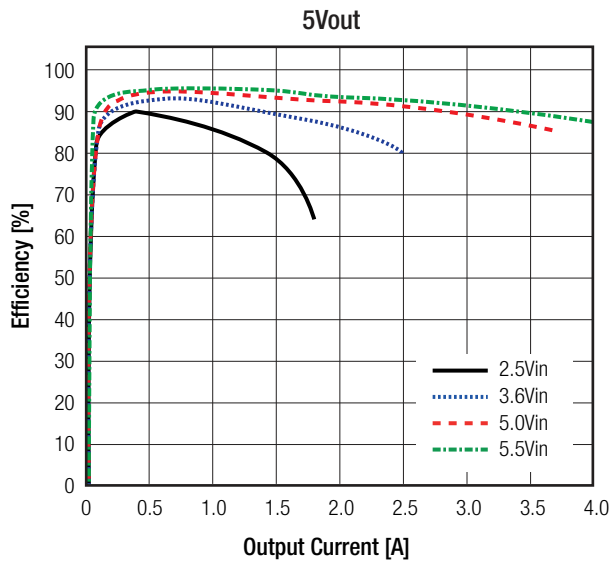

Safe Operating Area

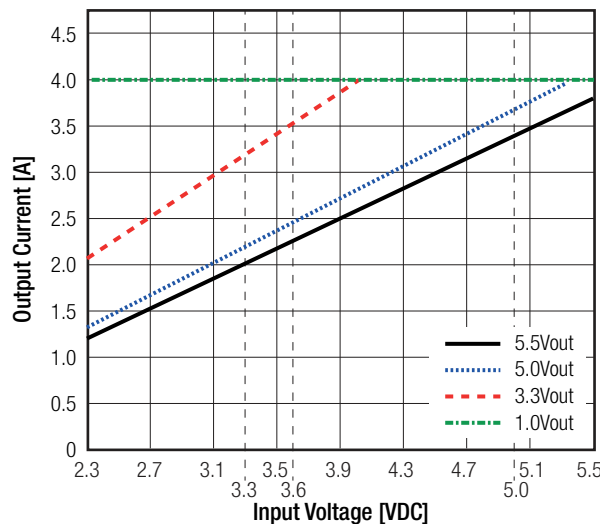

Specifications (measured @ Ta= 25°C, 5Vin, 5Vout, 2A and after warm-up unless otherwise stated)

OUTPUT VOLTAGE TRIMMING

The RBB10-2.0 series offers the feature of trimming the output voltage over a range between 1.0V and 5.5V by using external trim resistors. The values for trim resistors shown in trim tables below are according to standard E96 values; therefore, the specified voltage may slightly vary.

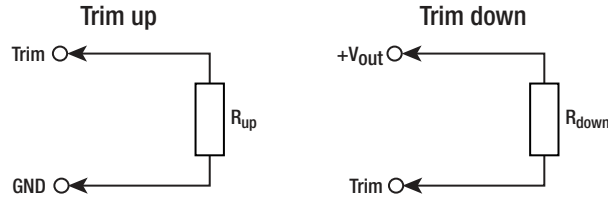

- V_{out_nom} = nominal output voltage [VDC]
- V_{out_set} = trimmed output voltage [VDC]
- V_{ref} = reference voltage [VDC]
- R_{up} = trim up resistor [Ω]
- R_{down} = trim down resistor [Ω]
- R₁, R₂, R₃ = internal resistors [Ω]

| V _{out_nom} | R ₁ | R ₂ | R ₃ | V _{ref} |
|----------------------|----------------|----------------|----------------|------------------|
| 5VDC | 629kΩ | 1kΩ | 788kΩ | 0.805 |

Calculation:

$$R_{up} = \left[\frac{R_1}{V_{out_set} - V_{nom}} \right] - R_2$$

$$R_{down} = \left[\frac{(V_{out_set} - V_{ref}) \times R_3}{V_{out_nom} - V_{out_set}} \right]$$

Practical Example RBB10-2.0:

$$R_{up} = \left[\frac{629k}{5.5 - 5.0} \right] - 1k = \underline{1M26\Omega}$$

$$R_{down} = \left[\frac{(4.0 - 0.805) \times 788k}{5.0 - 4.0} \right] = \underline{2M52\Omega}$$

R_{up} according to E96 ≈ 1M27Ω

R_{down} according to E96 ≈ 2M55Ω

RBB10-2.0

Trim up

| | | | | | | |
|-------------------------|------|------|------|------|------|-------|
| V _{out_set} = | 5.1 | 5.2 | 5.3 | 5.4 | 5.5 | [VDC] |
| R _{up} (E96) ≈ | 6M34 | 3M16 | 2M10 | 1M58 | 1M27 | [Ω] |

Trim down

| | | | | | | | | | | | |
|---------------------------|------|------|------|------|------|------|------|------|------|------|-------|
| V _{out_set} = | 4.5 | 4.0 | 3.5 | 3.3 | 3.0 | 2.5 | 2.0 | 1.8 | 1.5 | 1.0 | [VDC] |
| R _{down} (E96) ≈ | 5M90 | 2M55 | 1M43 | 1M15 | 866k | 536k | 316k | 243k | 158k | 38k3 | [Ω] |

REMOTE SENSE

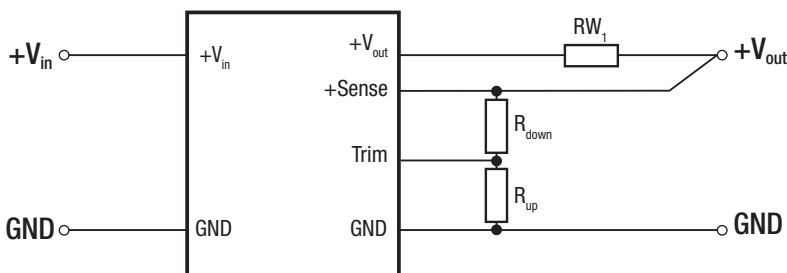

The output voltage can be adjusted via the trim and sense functions.

The maximum output voltage from Trim and Sense function combined is 5.5VDC. Derating may be required when using Trim and/or sense functions.

- RW₁ ... wire losses +
- R_{up} ... trim up resistor
- R_{down} ... trim down resistor

Specifications (measured @ Ta= 25°C, 5Vin, 5Vout, 2A and after warm-up unless otherwise stated)

| REGULATIONS | | | |
|---|--------------------------------------|----------------------------------|--------------------------|
| Parameter | Condition | | Value |
| Output Accuracy | | | ±3.0% max. |
| Line Regulation | low line to high line, full load | | 1.0% typ. / ±3.0% max. |
| Load Regulation | 0% to 100% load | PWM mode selected ⁽⁶⁾ | 0.5% max. |
| Transient Response | 100% - 0% load step recovery time | | 200mV max. 500µs typ. |
| Notes: | | | |
| Note6: The RBB10 has the possibility to work in two regulation modes: | | | |
| <p>Powersave Mode (standard): This mode is the best for use at low loads to reduce power consumption and extend battery life. In this mode the internal power consumption is reduced by using burst mode for loads under 350mA and PWM for loads above 350mA. The drawback is a 1-3 % higher output voltage at low load than full load.</p> <p>Fixed PWM mode: In PWM mode the device accurately regulates the output voltage independently of the load current. The drawback is a higher internal power consumption and shorter battery life at lower loads. Pull down the Mode pad to GND to enter this mode.</p> | | | |

| PROTECTIONS | | | |
|-----------------------------------|---|-----------------------|---|
| Parameter | Condition | | Value |
| Short Circuit Protection (SCP) | 50mΩ | | constant current limit |
| Short Circuit Input Current | nom. Vin= 2.3VDC | | 700mA typ. |
| Over Current Protection (OCP) | refer to safe operating area | | 220% - 240%, constant current mode |
| Over Temperature Protection (OTP) | case temperature (measured on tc point) | DC-DC OFF DC-DC ON | 110°C, auto restart after cool down 100°C typ. |

| ENVIRONMENTAL | | | |
|--|--|--------------------------------|--|
| Parameter | Condition | | Value |
| Operating Temperature Range ⁽⁷⁾ | @ natural convection 0.1m/s (refer to derating graph) | up to 4A load up to 2A load | -40°C to +85°C -40°C to +100°C |
| Maximum Case Temperature | | | +110°C |
| Temperature Coefficient | @ +65°C Tamb | | 0.02%/K |
| Thermal Impedance | 0.1m/s, horizontal (Tcase to Tamb) | | 8K/W |
| Operating Altitude | with derating @ natural convection 0.1m/s (refer to altitude vs. load graph) | | 5000m |
| Operating Humidity | non-condensing | | 5% - 95% RH max. |
| Shock | MIL-STD-810G, Method 516.6, Procedure I | | 40g, 11ms, saw-tooth, 3 shocks ± per axis 3 axis; unit is operating |
| | MIL-STD-810G, Method 516.6, Procedure IV | | drop on 50mm plywood on concrete 26 times from 1 meter |
| Temperature Cycling | MIL-STD-883F, Method 1010, Condition A | | powered -50°C to +85°C, 300 cycles |
| Random Vibration | MIL-STD-810G, Method 514.6, Procedure I, Category 24 | | Category 24 - Figure 514.6E-1 - power spectral density = 0.04g ² /Hz at 20Hz –1000Hz, -6dB/Octave at 1000Hz – 2000Hz, 60 minutes x 3 axis; unit is operating during tests |
| MTBF | according to MIL-HDBK-217F, G.B. | +25°C | 2200 x 10 ³ hours |
| | | +85°C | 400 x 10 ³ hours |
| Notes: | | | |
| Note7: tested with a eurocard 160x100mm 70µm copper, 4 layer | | | |

continued on next page

Specifications (measured @ Ta= 25°C, 5Vin, 5Vout, 2A and after warm-up unless otherwise stated)

Derating Graph ⁽⁷⁾

(@ chamber and natural convection 0.1m/s)

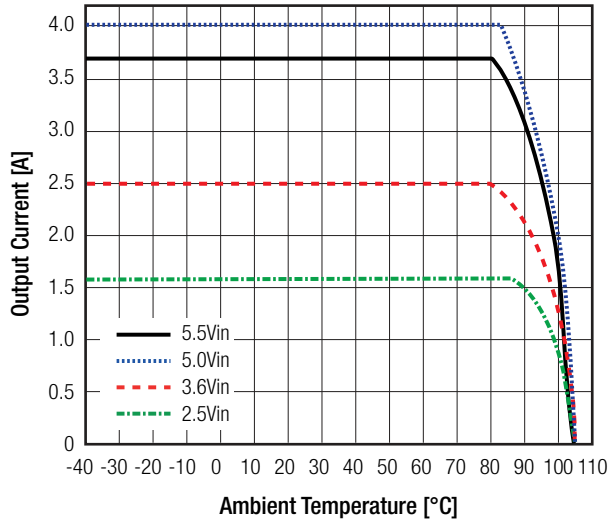

Operating Altitude vs Load

(@ chamber and natural convection 0.1m/s)

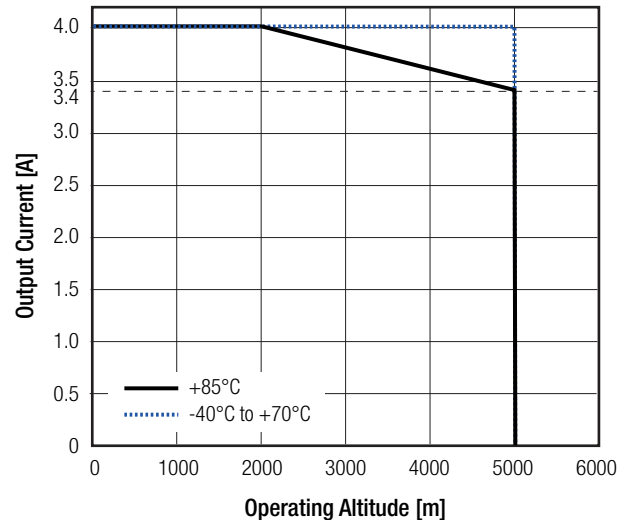

SAFETY AND CERTIFICATIONS

| Certificate Type (Safety) | Report / File Number | Standard |
|---------------------------|----------------------|------------------------------|
| RoHS 2+ | | RoHS 2011/65/EU + AM2015/863 |

| EMC Compliance | Condition | Standard / Criterion |
|---|--------------------------|----------------------|
| Electromagnetic compatibility of multimedia equipment - Emission requirements | with external components | EN55032, Class B |
| Information technology equipment - Immunity characteristics - Limits and methods of measurement | | EN55024:2010+A1:2015 |

EMC Filtering Suggestions according to EN55032

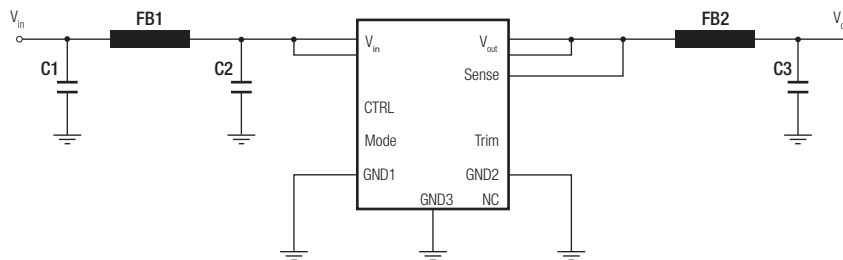

Component List Class B

| C1 | C2 | FB1 | FB2 | C3 |
|--------------|--------------|-----------------------|---------------------|--------------|
| 10µF 25V X7R | 10µF 25V X7R | WE ref.: 742792510 | WE ref.: 7427932 | 22µF 10V 7XR |

DIMENSION AND PHYSICAL CHARACTERISTICS

| Parameter | Type | Value |
|-------------------|-------------|--------------------------------------|
| Material | case | metal |
| | PCB | FR4, (UL94 V-0) |
| | solder pads | copper with electrolytic nickel-gold |
| Dimension (LxWxH) | | 12.19 x 12.19 x 3.75mm |
| Weight | | 1.1g typ. |

continued on next page

Specifications (measured @ Ta= 25°C, 5Vin, 5Vout, 2A and after warm-up unless otherwise stated)

Dimension Drawing (mm)

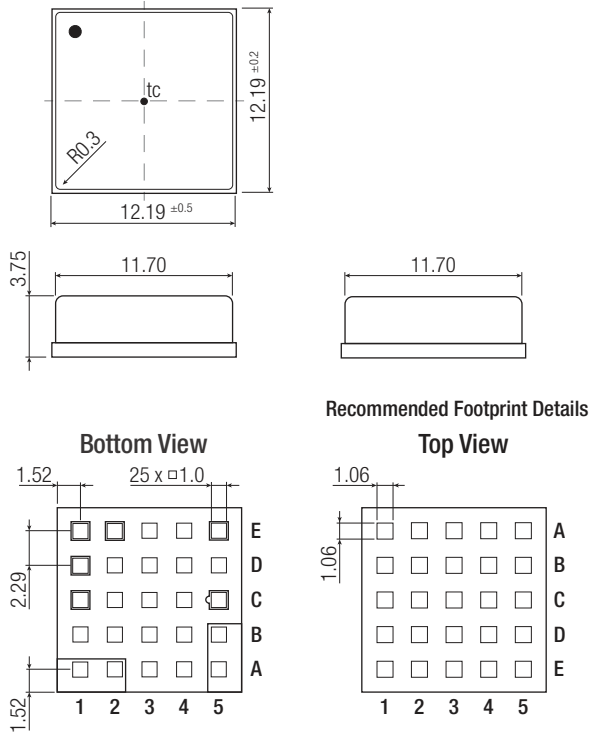

Pinning information

| Pad # | Function | Description |
|--|----------|---|
| A1, A2 | Vin | Positive input voltage with respect to GND. Connect to a Vin plane for enhanced thermal performance |
| C1 | CTRL | High active: pull to GND to disable the device. Pull high or leave open to enable the device |
| A5, B5 | Vout | Positive output voltage. Connect to a Vout plane for enhanced thermal performance |
| C5 | Sense | Connect this pad to the load or directly to Vout. This pad must not be left floating |
| E5 | Trim | Used to set the output voltage between 0.9V and 6V |
| E1 | NC | Not connected |
| E2 | Mode | Refer to note 6 on page RBB-4 |
| D1 | NC | Not connected |
| A3, A4, B1, B2, B3, B4, C2, C3, C4, D2, D3, D4, D5, E3, E4 | GND | Negative input voltage. Connect to GND plane(s) for enhanced thermal performance |

tc = case temperature measuring point
 Pad tolerance= ±0.05mm
 Case tolerance= ±0.25mm

BLOCKDIAGRAM

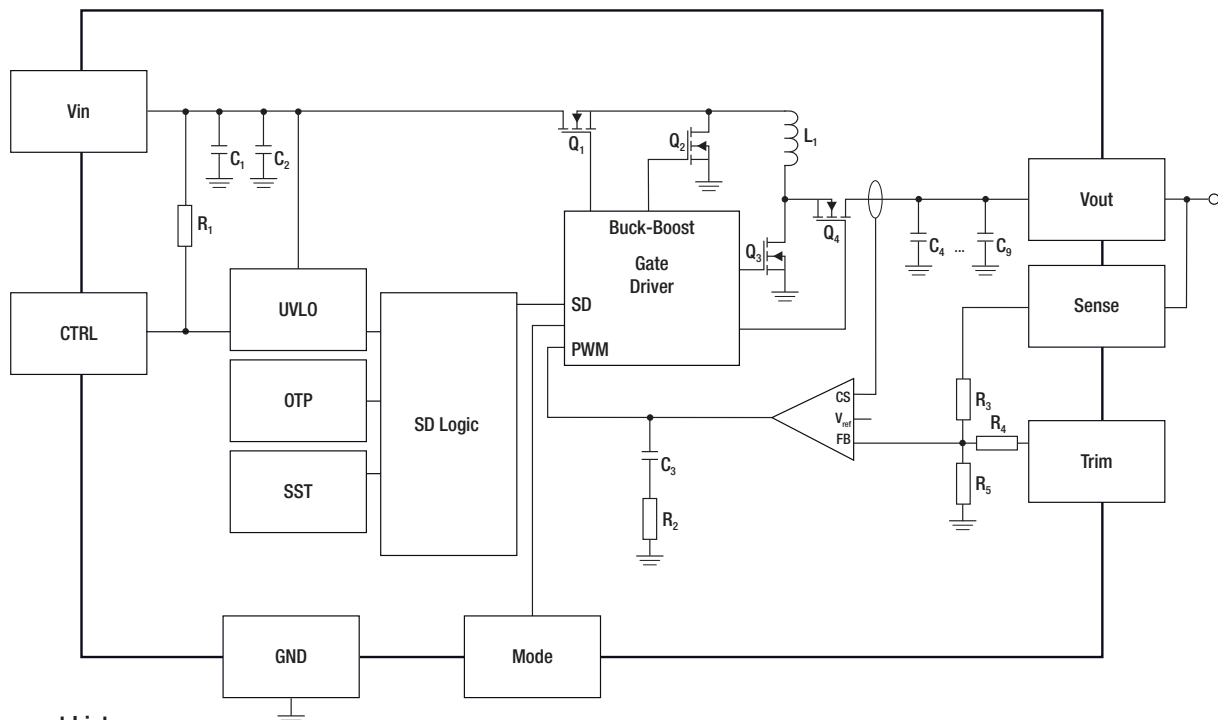

Component List

| C1, C2 | L1 | C4 - C9 | R3 | R4 | R5 |
|---------------------------|-----|---------------------------|-------|-----|-------|
| 10µF 2pcs. in parallel | 1µH | 10µF 6pcs. in parallel | 787kΩ | 1kΩ | 150kΩ |

Specifications (measured @ Ta= 25°C, 5Vin, 5Vout, 2A and after warm-up unless otherwise stated)

| PACKAGING INFORMATION | | |
|-----------------------------|------------------------|------------------------|
| Parameter | Type | Value |
| Packaging Dimension (LxWxH) | tape and reel | 330.2 x 330.2 x 30.4mm |
| | tape and reel (carton) | 365.0 x 365.0 x 55.0mm |
| | tube ("-CT") | 530.0 x 30.3 x 19.2mm |
| Packaging Quantity | tape and reel | 500pcs |
| | tube ("-CT") | 30pcs |
| Tape Width | | 24mm |
| Storage Temperature Range | | -55°C to +125°C |
| Storage Humidity | non-condensing | 95% RH max. |

The product information and specifications may be subject to changes even without prior written notice. The product has been designed for various applications; its suitability lies in the responsibility of each customer. The products are not authorized for use in safety-critical applications without RECOM's explicit written consent. A safety-critical application is an application where a failure may reasonably be expected to endanger or cause loss of life, inflict bodily harm or damage property. The applicant shall indemnify and hold harmless RECOM, its affiliated companies and its representatives against any damage claims in connection with the unauthorized use of RECOM products in such safety-critical applications.