

| REVISIONS | | | | | |
|-----------|--------|---|---------|--------|-------|
| REV | ECO | DESCRIPTION | DATE | BY | APPR |
| A1 | -- | RELEASE NEW DRAWING | 29DEC17 | RIMON | TOMMY |
| A2 | C0870S | Change the appearance of the retaining ring | 27JUN18 | KASOON | TOMMY |
| A3 | -- | UPDATE DIMENSION | 03NOV21 | LYNCH | TOMMY |

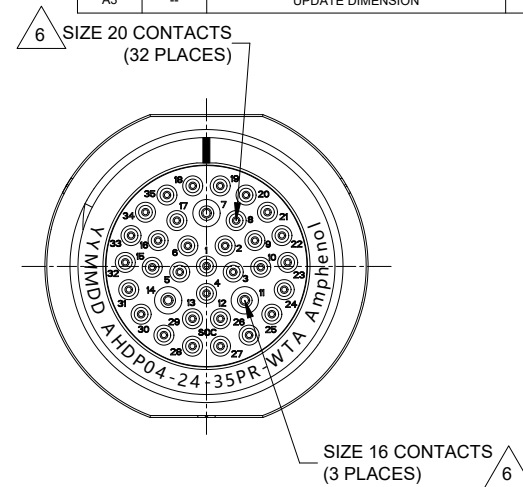
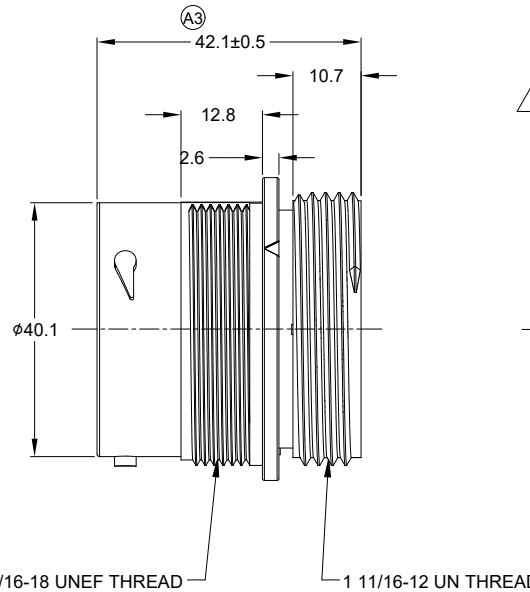
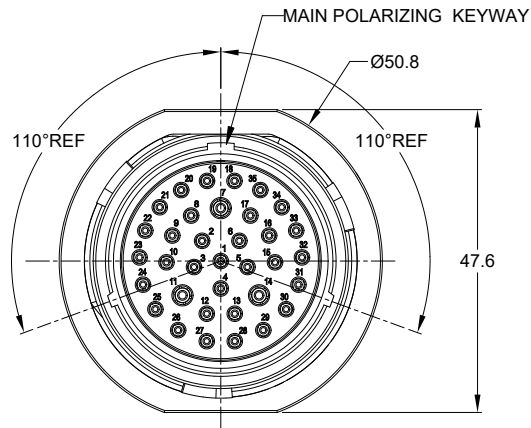

NOTES: UNLESS OTHERWISE SPECIFIED

- MATERIAL:
HOUSING: THERMOPLASTIC; BLACK
SEAL: SILICONE RUBBER
- MODIFICATIONS: THREADED ADAPTER;
REDUCED DIA. WIRE SEAL
- SPECIFICATIONS:
 - OPERATING TEMPERATURE: -55°C TO +125°C.
 - DIELECTRIC WITHSTANDING VOLTAGE: LESS THAN 2 MILLIAMPS CURRENT LEAKAGE @ 1500 VOLTS AC.
 - INSULATION RESISTANCE: 1000 MEGOHM MIN @ 25°C.
 - MOISTURE RESISTANCE:
IP68(IM OF WATER FOR A PERIOD OF 24 HOURS, MATED CONDITION);
IP69K(MATED CONDITION)
 - MATING CYCLE DURABILITY: 100 CYCLES
 - RoHS COMPLIANT
- MATING PART: AHDPO6-24-35P* (* = SEAL TYPE)
- ALL DIMENSIONS ARE FOR REFERENCE USE ONLY.

6 CONTACT SIZE AND WIRE RANGE:

| CONTACT SIZE | MIN. INSUL O.D. | MAX. INSUL O.D. | TYPICAL WIRE RANGE | CURRENT RATING |
|--------------|-------------------|-------------------|--------------------------------------|----------------|
| 20 | 1.02 mm (.040 in) | 2.41 mm (.095 in) | 16-22 AWG (1.5-0.35mm ²) | 7.5 AMPS |
| 16 | 1.35 mm (.053in) | 3.05 mm (.120 in) | 14-20 AWG (2.0-0.5mm ²) | 13 AMPS |

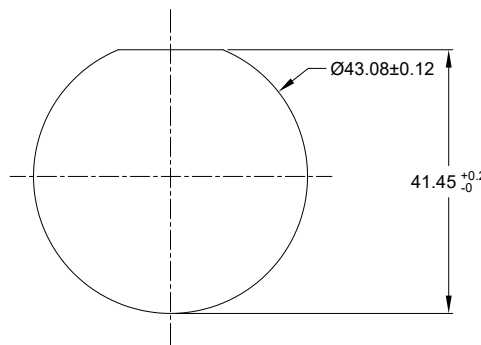

RECOMMENDED PANEL MOUNTING HOLE

RECOMMENDED PANEL THICKNESS: 1.6 TO 4.7MM

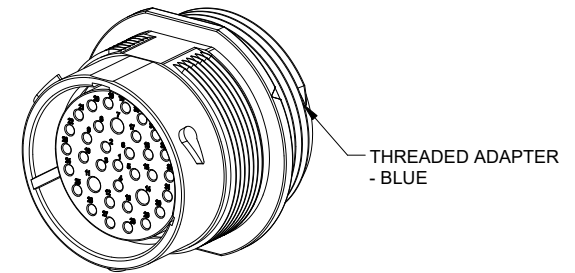



| QUANTITY | AHDPO4-24-35SR-WTA | DESCRIPTION | ITEM |
|--------------------------------------|--------------------|--|--------------|
| MATERIALS LIST | | | |
| UNLESS OTHERWISE SPECIFIED | | SIGNATURES DATE | |
| 1) All dimensions are in metric(mm). | | DRAWN: LYNCHPAN | 03NOV21 |
| 2) Tolerances are as follows: | | CHECKED: SULLENZHANG | 03NOV21 |
| 1 PL DEC ±0.30 | | ENGINEER: | |
| 2 PL DEC ±0.15 | | APPROVAL: TOMMY.XIE | 05NOV21 |
| 3 PL DEC ±0.08 | | CUSTOMER: | |
| 3) Note reference = | | MATERIAL SPECIFICATIONS: | |
| WEIGHT: 56.8G | | THIS DRAWING IS SUPPLIED FOR INFORMATION ONLY. DESIGN FEATURES, SPECIFICATIONS AND PERFORMANCE DATA SHOWN HEREON ARE THE PROPERTY OF THE AMPHENOL CORPORATION. NO RIGHTS OF REPRODUCTION ARE IMPLIED. ALL DIMENSIONS ARE SUBJECT TO NORMAL MANUFACTURING VARIATIONS. | |
| PROCESS SPECIFICATIONS: | | SIZE | TYPE |
| NEXT ASSY: | | B | C- |
| | | DWG NO: AHDPO4-24-35SR-WTA | |
| | | REVISION A3 | |
| | | SCALE: NONE | SHEET 1 OF 1 |



7. RECEPTACLE IS SUPPLIED WITH DUST CAP.





TITLE: RECEPTACLE 24-35 POS, SOCKET CONTACT, REDUCED DIA. SEAL, AHDP DWG NO: AHDPO4-24-35SR-WTA REV: A3 SH: 1 OF: 1

ATM Series™ - Contact Size 20 Options

| Machined Contacts, Sockets & Pins | | | | |
|-----------------------------------|--|------|-------|----------|
| Part Number | Description | Size | AWG | Type |
| AT60-010-2031 | Male Contact - Pin, Gold-plated | 20 | 16-18 | Machined |
| AT62-005-20141 | Female Contact - Socket, Gold-plated | 20 | 16-18 | Machined |
| AT60-010-20141 | Male Contact - Pin, Nickel-plated | 20 | 16-18 | Machined |
| AT62-005-2031 | Female Contact - Socket, Nickel-plated | 20 | 16-18 | Machined |
| AT60-202-2031 | Male Contact - Pin, Gold-plated | 20 | 20-22 | Machined |
| AT62-201-2031 | Female Contact - Socket, Gold-plated | 20 | 20-22 | Machined |
| AT60-202-20141 | Male Contact - Pin, Nickel-plated | 20 | 20-22 | Machined |
| AT62-201-20141 | Female Contact - Socket, Nickel-plated | 20 | 20-22 | Machined |

| Tooling - Machined Contacts | | |
|---|-------------|---|
| Part | Part Number | Description |
|  | CA-5D12 | Universal Hand Crimp Tool, Size 12/16/20 (Machined contacts only) |
|  | CA-5E12 | Pneumatic Crimp Tool, Size 12/16/20 (Machined contacts only) |

| Contact Removal Tools | | |
|---|---------------|---|
| Part | Part Number | Description |
|  | ATRT-100 | Used for removal of contacts for A Series™ products |
|  | AT11-240-2005 | Contact Removal Tool, Plastic, Size 20 |



| Sealing Plugs | | |
|---|-------------------|--|
| Part | Part Number | Description |
|  | AT13-204-2005 | Sealing Plug, Size 20, White |
|  | AT13-204-2005-SR | Sealing Plug, Size 20, SR01 Series, Black |
|  | ATM13-217-2005 | Locking Sealing Plug, Size 20, Grey |
|  | ATM13-217-2005-SR | Locking Sealing Plug, Size 20, SR01 Series, Blue |

| Stamped & Formed Contacts, Sockets & Pins | | | | |
|---|--|------|-------|------------------|
| Part Number | Description | Size | AWG | Type |
| AT60-20-0144 | Male Contact - Pin, Gold-plated | 20 | 16-22 | Stamped & Formed |
| AT62-20-0144 | Female Contact - Socket, Gold-plated | 20 | 16-22 | Stamped & Formed |
| AT60-20-0244 | Male Contact - Socket, Gold-plated | 20 | 16-22 | Stamped & Formed |
| AT62-20-0244 | Female Contact - Socket, Gold-plated | 20 | 16-22 | Stamped & Formed |
| AT60-20-0122 | Male Contact - Pin, Nickel-plated | 20 | 16-22 | Stamped & Formed |
| AT62-20-0122 | Female Contact - Socket, Nickel-plated | 20 | 16-22 | Stamped & Formed |
| AT60-20-0222 | Male Contact - Socket, Nickel-plated | 20 | 16-22 | Stamped & Formed |
| AT62-20-0222 | Female Contact - Socket, Nickel-plated | 20 | 16-22 | Stamped & Formed |
| AT60-20-0277 | Male Contact - Socket, Tin-plated | 20 | 16-22 | Stamped & Formed |
| AT62-20-0277 | Female Contact - Socket, Tin-plated | 20 | 16-22 | Stamped & Formed |
| AT60-20-0422 | Male Contact - Socket, Nickel-plated | 20 | 20-22 | Stamped & Formed |
| AT62-20-0444 | Female Contact - Socket, Gold-plated | 20 | 20-22 | Stamped & Formed |





| Tooling - Stamped & Formed Contacts | | |
|---|-------------|---|
| Part | Part Number | Description |
|  | MFX-3974 | Crimp Die - Size 20 (S&F contacts only) |
| | MFX-3976 | Crimp Die - Size 20 (S&F contacts only) 20-22AWG -04XX Series |
| | MFX-3978 | Crimp Die - Size 20 (S&F contacts only) 20-22AWG -02XX Series |
|  | ATT-20-00 | Hand Crimp Tool - Size 20, 20AWG (S&F contacts only) |

AT Series™ - Contact Size 16 Options



| Machined Contacts, Sockets & Pins | | | | |
|-----------------------------------|--|------|-------|----------|
| Part Number | Description | Size | AWG | Type |
| AT60-215-1631 | Male Contact - Pin, Gold-plated | 16 | 14 | Machined |
| AT62-209-1631 | Female Contact - Socket, Gold-plated | 16 | 14 | Machined |
| AT60-215-16141 | Male Contact - Pin, Nickel-plated | 16 | 14 | Machined |
| AT62-209-16141 | Female Contact - Socket, Nickel-plated | 16 | 14 | Machined |
| AT60-202-1631 | Male Contact - Pin, Gold-plated | 16 | 16-20 | Machined |
| AT62-201-1631 | Female Contact - Socket, Gold-plated | 16 | 16-20 | Machined |
| AT60-202-16141 | Male Contact - Pin, Nickel-plated | 16 | 16-20 | Machined |
| AT62-201-16141 | Female Contact - Socket, Nickel-plated | 16 | 16-20 | Machined |
| AT60-202-1631-22 | Male Contact - Pin, Gold-plated | 16 | 22-24 | Machined |
| AT62-201-1631-22 | Female Contact - Socket, Gold-plated | 16 | 22-24 | Machined |
| AT60-202-16141-22 | Male Contact - Pin, Nickel-plated | 16 | 22-24 | Machined |
| AT62-201-16141-22 | Female Contact - Socket, Nickel-plated | 16 | 22-24 | Machined |

| Tooling - Machined Contacts | | |
|---|-------------|---|
| Part | Part Number | Description |
|  | CA-5D12 | Universal Hand Crimp Tool, Size 12/16/20 (Machined contacts only) |
|  | CA-5E12 | Pneumatic Crimp Tool, Size 12/16/20 (Machined contacts only) |

| Contact Removal Tools | | |
|---|---------------|---|
| Part | Part Number | Description |
|  | ATRT-100 | Used for removal of contacts for A Series™ products |
|  | AT11-310-1605 | Contact Removal Tool, Plastic, Size 16 |

| Sealing Plugs | | |
|---|------------------|---|
| Part | Part Number | Description |
|  | A114017 | Sealing Plug, Size 16, White |
|  | A114017-SR | Sealing Plug, Size 16, SR01 Series, Black |
|  | AT13-217-1605 | Locking Sealing Plug, Size 16, Grey |
|  | AT13-217-1605-SR | Locking Sealing Plug, Size 16, SR01 Series, Red |

| Stamped & Formed Contacts, Sockets & Pins | | | | |
|---|--|------|-------|------------------|
| Part Number | Description | Size | AWG | Type |
| AT60-14-0144 | Male Contact - Pin, Gold-plated | 16 | 14-16 | Stamped & Formed |
| AT62-14-0144 | Female Contact - Socket, Gold-plated | 16 | 14-16 | Stamped & Formed |
| AT60-14-0122 | Male Contact - Pin, Nickel-plated | 16 | 14-16 | Stamped & Formed |
| AT62-14-0122 | Female Contact - Socket, Nickel-plated | 16 | 14-16 | Stamped & Formed |
| AT60-16-0144 | Male Contact - Pin, Gold-plated | 16 | 16-18 | Stamped & Formed |
| AT62-16-0144 | Female Contact - Socket, Gold-plated | 16 | 16-18 | Stamped & Formed |
| AT60-16-0122 | Male Contact - Pin, Nickel-plated | 16 | 16-18 | Stamped & Formed |
| AT62-16-0122 | Female Contact - Socket, Nickel-plated | 16 | 16-18 | Stamped & Formed |
| AT60-16-0644 | Male Contact - Pin, Gold-plated | 16 | 18-20 | Stamped & Formed |
| AT62-16-0644 | Female Contact - Socket, Gold-plated | 16 | 18-20 | Stamped & Formed |
| AT60-16-0622 | Male Contact - Pin, Nickel-plated | 16 | 18-20 | Stamped & Formed |
| AT62-16-0622 | Female Contact - Socket, Nickel-plated | 16 | 18-20 | Stamped & Formed |
| AT60-16-0844 | Male Contact - Pin, Gold-plated | 16 | 20-22 | Stamped & Formed |
| AT62-16-0844 | Female Contact - Socket, Gold-plated | 16 | 20-22 | Stamped & Formed |
| AT60-16-0822 | Male Contact - Pin, Nickel-plated | 16 | 20-22 | Stamped & Formed |
| AT62-16-0822 | Female Contact - Socket, Nickel-plated | 16 | 20-22 | Stamped & Formed |

| Tooling - Stamped & Formed Contacts | | |
|--|-------------|---|
| Part | Part Number | Description |
|  | MFY-3950 | Crimp Die - Size 16, 18-20AWG (S&F contacts only) |
| | MFY-3953 | Crimp Die - Size 16, 16-18AWG (S&F contacts only) |
| | MFY-3975 | Crimp Die - Size 16, 14-16AWG (S&F contacts only) |
| | MFY-3990 | Crimp Die - Size 16, 20-22AWG (S&F contacts only) |
|  | ATT-16-00 | Hand Crimp Tool - Size 16, 14-16AWG (S&F contacts only) |
| | ATT-16-01 | Hand Crimp Tool - Size 16, 18-20AWG (S&F contacts only) |
| | ATT-1612-03 | Hand Crimp Tool - Size 16, 20-22AWG (S&F contacts only) |