

Manual Motor Starters

- *Complete Ranges up to 100 Amps*
- *ON-OFF-Trip Three Position Operator*
- *Unique Handle Lock in the OFF Position*
- *Class 10, 20 Overload Trip Characteristics*
- *DIN Rail or Back Panel Mounting*
- *Finger Safe Terminals*
- *Trip Test*



**With
Extended
Warranty**



Carlo Gavazzi GMS Manual Motor Starters provide complete ranges up to 100A



0.1~0.16... 22~32A (16 step)

GMS 32S



Standard

GMS 32H
GMS 32HI



High break
Magnetic release

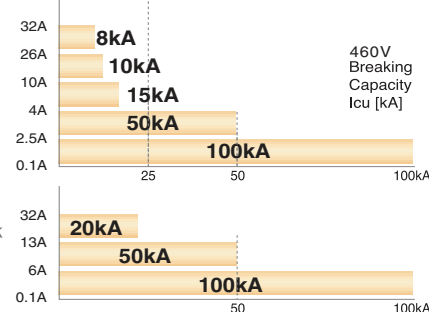

32AF

6~10... 45~63A (9 step)

GMS 63S



Standard

GMS 63H
GMS 63HI
GMS 63HL



High break
Magnetic release
Class 20

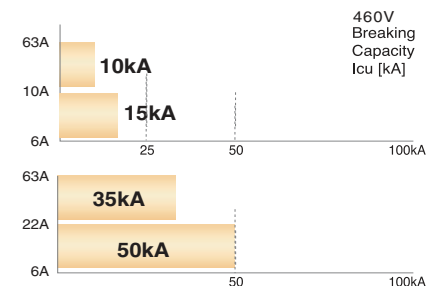

63AF

11~17... 80~100A (10 step)

GMS 100S



Standard

GMS 100H
GMS 100HI
GMS 100HL



High break
Magnetic release
Class 20

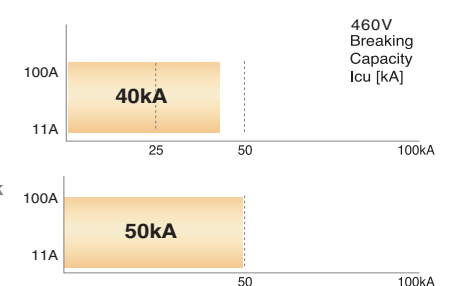

100AF

Carlo Gavazzi GMS Manual Motor Starters deliver more efficiency through various functions and compact design

Common use from 32 to 100AF
A wide variety of accessories enables a flexible response to changes in specifications



[Scale 1:1]

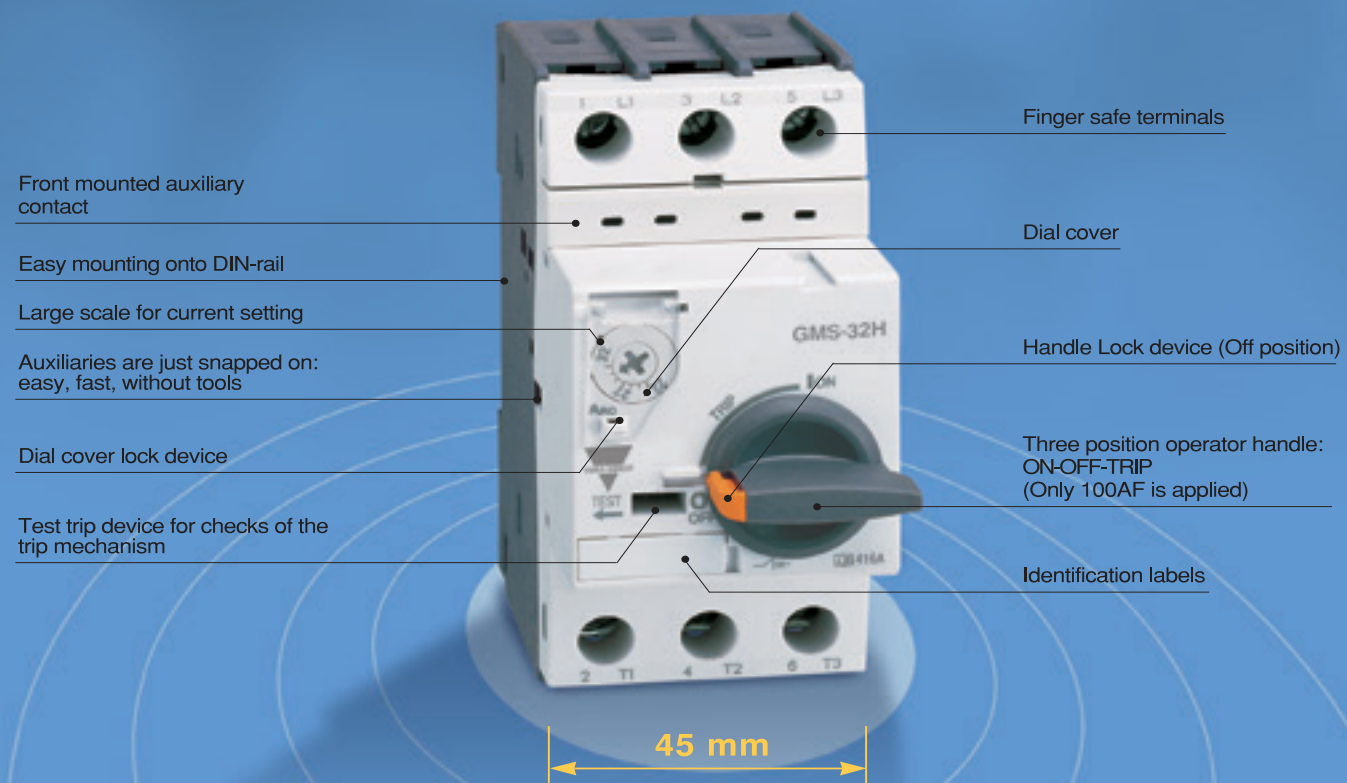

Accessories
Accessories
Accessories

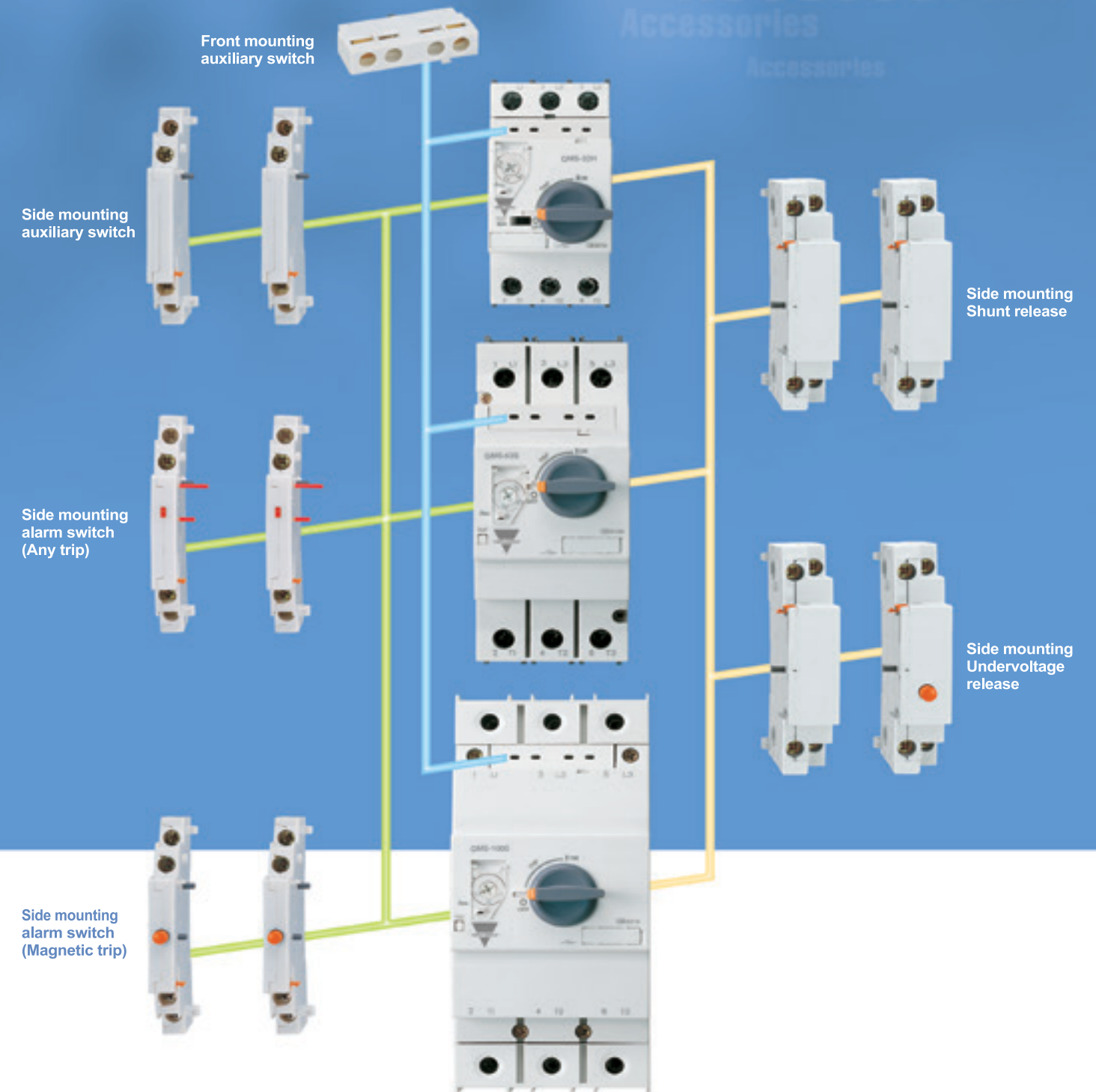

Handle Lock

Dial cover

Terminals



GMS32



GMS63



GMS100



Contents

Product Selection Guide	
Quick selection table ...IEC rating	8
Motor protection	10
Short-circuit protection for starters	12
Accessories	14
Busbar Accessories	16
Technical Information	
IEC performance data (motor protection).....	18
IEC performance data (Short-circuit protection for starters).....	21
IEC Performance data (Motor protection: Class 20)	22
UL/CSA performance data (Motor protection).....	23
Manual Motor Controller (UL508)	26
General data	28
Type 'Z' coordination according to IEC 947-4-1	32
Time/Current characteristic	33
Dimensions	34



Function

- Protection of group installation
- Protection of circuits
- Motor protection
- Starter protection
- Wide range of ambient temperature compensation
- Phase failure protection



Feature

- 45mm width up to 32A, 55mm width up to 63A and 70mm width rated to 100 amps
- Three position operator: ON-OFF-TRIP (Only 100AF is applied)
- Complete range of common accessories
- Handle lock in the OFF position
- Class 10,20 overload trip characteristics
- Trip test
- Finger safe terminal
- DIN rail and screw mounting

Standard

- The components fulfill the international standard IEC 60947
- The devices can be used as Manual Motor Starter in Group Installations According to UL508.



Quick selection table ... IEC rating



Frame		32AF										63AF										100AF																				
Type	Current adjustable type	GMS-32S					GMS-32H					GMS-63S					GMS-63H					GMS-100S					GMS-100H															
	Instantaneous type	-					GMS-32HI					-					GMS-63HI					-					GMS-100HI															
Breaking capacity	Class 20	-					-					-					-					-					-															
	Handle Type	Standard					High break					Standard					High break					Standard					High break															
Number of poles		3										3										3																				
Rated operational voltage (Ue)		Up to 690V										Up to 690V										Up to 690V																				
Rated frequency		50/60 Hz										50/60 Hz										50/60 Hz																				
Rated insulation voltage (Ui)		690V										690V										1,000V																				
Rated impulse voltage (Uimp)		6kV										6kV										8kV																				
Utilization category	IEC 60 947-2 (Breaker)	Cat. A					Cat. A					Cat. A					Cat. A					Cat. A																				
	IEC 60 947-4 (Motor starter)	AC 3					AC 3					AC 3					AC 3					AC 3																				
Shock resistance (IEC 68 Part 2-27)		25g										25g										25g																				
Degree of protection (IEC 60 529)		IP 20										IP 20										IP 20																				
Instantaneous short circuit release		13 × Ie max.										13 × Ie max.										13 × Ie max.																				
Mechanical endurance (Operating)		100,000										100,000										50,000																				
Electrical endurance (Cycles)		100,000										100,000										25,000																				
Max operating frequency per hour (Ope./h)		25										25										25																				
Temperature compensation (Operation)		-20 ~ +60 °C										-20 ~ +60 °C										-20 ~ +60 °C																				
Phase failure function		○										○										○																				
Trip indicating function		×										×										×																				
Test function		○										○										○																				
Rated breaking capacity (kA)	Rated operational current (Ie)	Thermal release Adjustment range (A)	240V 230V		415V 400V		460V 440V		525V 500V		690V 600V		240V 230V		415V 400V		460V 440V		525V 500V		690V 600V		240V 230V		415V 400V		460V 440V		525V 500V		690V 600V		240V 230V		415V 400V		460V 440V		525V 500V		690V 600V	
			Icu	Ics	Icu	Ics	Icu	Ics	Icu	Ics	Icu	Ics	Icu	Ics	Icu	Ics	Icu	Ics	Icu	Ics	Icu	Ics	Icu	Ics	Icu	Ics	Icu	Ics	Icu	Ics	Icu	Ics	Icu	Ics	Icu	Ics	Icu	Ics	Icu	Ics		
0.16	0.1~0.16	100	100	100	100	100	100	100	100	100	100	100	100	100	100	100	100	100	100	100	100	100	100	100	100	100	100	100	100	100	100	100	100	100	100	100	100	100	100	100	100	100
0.25	0.16~0.25	100	100	100	100	100	100	100	100	100	100	100	100	100	100	100	100	100	100	100	100	100	100	100	100	100	100	100	100	100	100	100	100	100	100	100	100	100	100	100	100	100
0.4	0.25~0.4	100	100	100	100	100	100	100	100	100	100	100	100	100	100	100	100	100	100	100	100	100	100	100	100	100	100	100	100	100	100	100	100	100	100	100	100	100	100	100	100	100
0.63	0.4~0.63	100	100	100	100	100	100	100	100	100	100	100	100	100	100	100	100	100	100	100	100	100	100	100	100	100	100	100	100	100	100	100	100	100	100	100	100	100	100	100	100	100
1	0.63~1	100	100	100	100	100	100	100	100	100	100	100	100	100	100	100	100	100	100	100	100	100	100	100	100	100	100	100	100	100	100	100	100	100	100	100	100	100	100	100	100	
1.6	1~1.6	100	100	100	100	100	100	100	100	100	100	100	3	3	100	100	100	100	100	100	100	100	100	100	100	100	100	100	100	100	100	100	100	100	100	100	100	100	100	100	100	
2.5	1.6~2.5	100	100	100	100	100	100	50	38	3	3	100	100	100	100	100	100	100	100	100	100	100	100	100	100	100	100	100	100	100	100	100	100	100	100	100	100	100	100	100	100	
4	2.5~4	100	100	100	100	50	38	15	11	3	3	100	100	100	100	100	100	100	100	100	100	100	100	100	100	100	100	100	100	100	100	100	100	100	100	100	100	100	100	100	100	100
6	4~6	100	100	100	100	15	11	10	8	3	3	100	100	100	100	100	100	100	100	100	100	100	100	100	100	100	100	100	100	100	100	100	100	100	100	100	100	100	100	100	100	100
8	5~8	100	100	100	100	15	11	10	8	3	3	100	100	100	100	50	38	50	38	6	6	6	6	6	6	6	6	6	6	6	6	6	6	6	6	6	6	6	6	6		
10	6~10	100	100	50	38	15	11	6	5	3	3	100	100	100	100	50	38	50	38	6	6	6	6	6	6	6	6	6	6	6	6	6	6	6	6	6	6	6	6	6		
13	9~13	100	100	50	38	10	8	6	5	3	3	100	100	100	100	50	38	42	32	6	6	6	6	6	6	6	6	6	6	6	6	6	6	6	6	6	6	6	6	6		
17	11~17	50	38	20	15	10	8	6	5	3	3	100	100	50	38	20	15	10	8	4	4	4	4	4	4	4	4	4	4	4	4	4	4	4	4	4	4	4	4	4		
22	14~22	40	30	15	11	8	6	6	5	3	3	100	100	50	38	20	15	10	8	4	4	4	4	4	4	4	4	4	4	4	4	4	4	4	4	4	4	4	4	4		
26	18~26	40	30	15	11	8	6	6	5	3	3	100	100	50	38	20	15	10	8	4	4	4	4	4	4	4	4	4	4	4	4	4	4	4	4	4	4	4	4	4		
32	22~32	30	22	15	11	6	4	5	4	3	3	100	100	50	38	20	15	10	8	4	4	4	4	4	4	4	4	4	4	4	4	4	4	4	4	4	4	4	4	4		
40	28~40	-	-	-	-	-	-	-	-	-	-	-	-	-	-	-	-	-	-	-	-	-	-	-	-	-	-	-	-	-	-	-	-	-	-	-	-	-				
50	34~50	-	-	-	-	-	-	-	-	-	-	-	-	-	-	-	-	-	-	-	-	-	-	-	-	-	-	-	-	-	-	-	-	-	-	-	-	-				
63	45~63	-	-	-	-	-	-	-	-	-	-	-	-	-	-	-	-	-	-	-	-	-	-	-	-	-	-	-	-	-	-	-	-	-	-	-	-	-				
75	55~75	-	-	-	-	-	-	-	-	-	-	-	-	-	-	-	-	-	-	-	-	-	-	-	-	-	-	-	-	-	-	-	-	-	-	-	-					
90	70~90	-	-	-	-	-	-	-	-	-	-	-	-	-	-	-	-	-	-	-	-	-	-	-	-	-	-	-	-	-	-	-	-	-	-	-	-					
100	80~100	-	-	-	-	-	-	-	-	-	-	-	-	-	-	-	-	-	-	-	-	-	-	-	-	-	-	-	-	-	-	-	-	-	-	-	-					

Ordering Example: Specify Rated Operational Current
 GMS-32S-0.16 (0.1 to 0.16)
 GMS-32S-0.25 (0.16 to 0.25)



Motor protection

- Adjustable thermal release
- Magnetic release $13 \times I_e$ max.
- Trip class 10
- Ambient temperature compensation
- Phase-failure protection



GMS-32S



GMS-32H

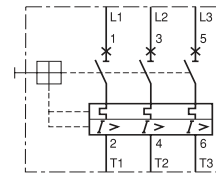

(Circuit diagram)

Type	Rated operational current I_e [A]	Thermal release Adjustment range [A]	Magnetic release Operating current [A]	Switching of 3 phase AC motors, AC-2, AC-3						440/460V		
				3-phase [kW] (50/60Hz)			3-phase [HP] (60Hz)			I_{cu} [kA]	I_{cs} [kA]	
				230V	400V	690V	230V	460V	575V			
GMS-32S (Standard)	0.16	0.1...0.16	2.1	-	0.02	-	-	-	-	-	100	100
	0.25	0.16...0.25	3.3	0.03	0.06	-	-	-	-	-	100	100
	0.4	0.25...0.4	5.2	0.06	0.09	-	-	-	-	-	100	100
	0.63	0.4...0.63	8.2	0.09	0.12	0.25	-	-	-	-	100	100
	1	0.63...1.0	13	0.12	0.25	0.55	-	1/2	1/2	-	100	100
	1.6	1.0...1.6	20.8	0.25	0.55	1.1	1/3	3/4	1	-	100	100
	2.5	1.6...2.5	32.5	0.37	0.75	1.5	1/2	1 1/2	1 1/2	-	100	100
	4	2.5...4.0	52	0.75	1.5	3	1	2	3	-	50	38
	6	4...6	78	1.5	2.2	4	1 1/2	5	5	-	15	11
	8	5...8	104	1.5	3	5.5	2	5	5	-	15	11
	10	6...10	130	3	4	7.5	3	7 1/2	10	-	15	11
	13	9...13	169	3	5.5	11	3	7 1/2	10	-	10	8
	17	11...17	221	4	7.5	11	5	10	15	-	10	8
	22	14...22	286	4	7.5	15	7 1/2	15	20	-	8	6
26	18...26	338	5.5	11	18.5	7 1/2	15	20	-	8	6	
32	22...32	416	7.5	15	22	10	20	30	-	6	4	
GMS-32H (High break)	0.16	0.1...0.16	2.1	-	0.02	-	-	-	-	-	100	100
	0.25	0.16...0.25	3.3	0.03	0.06	-	-	-	-	-	100	100
	0.4	0.25...0.4	5.2	0.06	0.09	-	-	-	-	-	100	100
	0.63	0.4...0.63	8.2	0.09	0.12	0.25	-	-	-	-	100	100
	1	0.63...1.0	13	0.12	0.25	0.55	-	1/2	1/2	-	100	100
	1.6	1.0...1.6	20.8	0.25	0.55	1.1	1/3	3/4	1	-	100	100
	2.5	1.6...2.5	32.5	0.37	0.75	1.5	1/2	1 1/2	1 1/2	-	100	100
	4	2.5...4.0	52	0.75	1.5	3	1	2	3	-	100	100
	6	4...6	78	1.5	2.2	4	1 1/2	5	5	-	100	100
	8	5...8	104	1.5	3	5.5	2	5	5	-	50	38
	10	6...10	130	3	4	7.5	3	7 1/2	10	-	50	38
	13	9...13	169	3	5.5	11	3	7 1/2	10	-	50	38
	17	11...17	221	4	7.5	11	5	10	15	-	20	15
	22	14...22	286	4	7.5	15	7 1/2	15	20	-	20	15
26	18...26	338	5.5	11	18.5	7 1/2	15	20	-	20	15	
32	22...32	416	7.5	15	22	10	20	30	-	20	15	

- Adjustable thermal release
- Magnetic release $13 \times I_e$ max.
- Trip class 10
- Ambient temperature compensation
- Phase-failure protection



GMS-63H



GMS-100H

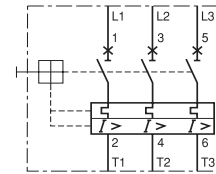

(Circuit diagram)

Type	Rated operational current I_e [A]	Thermal release Adjustment range [A]	Magnetic release Operating current [A]	Switching of 3 phase AC motors, AC-2, AC-3						440/460V	
				3-phase [kW] (50/60Hz)			3-phase [HP] (60Hz)			I_{cu} [kA]	I_{cs} [kA]
				230V	400V	690V	230V	460V	575V		
GMS-63S (Standard)	10	6~10	130	3	4	7.5	3	7 1/2	10	15	12
	13	9~13	169	3	5.5	11	3	7 1/2	10	10	8
	17	11~17	221	4	7.5	11	5	10	15	10	8
	22	14~22	286	4	7.5	15	7 1/2	15	20	10	8
	26	18~26	338	5.5	11	18.5	10	20	25	10	8
	32	22~32	416	7.5	15	22	10	25	30	10	8
	40	28~40	520	7.5	18.5	30	15	30	40	10	8
	50	34~50	650	11	22	45	15	40	50	10	8
	63	45~63	819	15	30	55	20	50	60	10	8
	10	6~10	130	3	4	7.5	3	7 1/2	10	50	38
GMS-63H (High break)	13	9~13	169	3	5.5	11	3	7 1/2	10	50	38
	17	11~17	221	4	7.5	11	5	10	15	50	38
	22	14~22	286	4	7.5	15	7 1/2	15	20	50	38
	26	18~26	338	5.5	11	18.5	10	20	25	35	27
	32	22~32	416	7.5	15	22	10	25	30	35	27
	40	28~40	520	7.5	18.5	30	15	30	40	35	27
	50	34~50	650	11	22	45	15	40	50	35	27
	63	45~63	819	15	30	55	20	50	60	35	27
	17	11~17	221	4	7.5	11	5	10	15	40	30
	22	14~22	286	4	7.5	15	7 1/2	15	20	40	30
GMS-100S (Standard)	26	18~26	338	5.5	11	18.5	10	20	25	40	30
	32	22~32	416	7.5	15	22	10	25	30	40	30
	40	28~40	520	7.5	18.5	30	15	30	40	40	30
	50	34~50	650	11	22	45	15	40	50	40	30
	63	45~63	819	15	30	55	20	50	60	40	30
	75	55~75	975	22	37	63	25	60	75	40	30
	90	70~90	1170	30	45	75	30	75	100	40	30
	100	80~100	1300	30	45	90	40	75	100	40	30
	17	11~17	221	4	7.5	11	5	10	15	50	38
	22	14~22	286	4	7.5	15	7 1/2	15	20	50	38
GMS-100H (High break)	26	18~26	338	5.5	11	18.5	10	20	25	50	38
	32	22~32	416	7.5	15	22	10	25	30	50	38
	40	28~40	520	7.5	18.5	30	15	30	40	50	38
	50	34~50	650	11	22	45	15	40	50	50	38
	63	45~63	819	15	30	55	20	50	60	50	38
	75	55~75	975	22	37	63	25	60	75	50	38
	90	70~90	1170	30	45	75	30	75	100	50	38
	100	80~100	1300	30	45	90	40	75	100	50	38



Short-circuit protection for starters

- Without thermal releases
- Magnetic release $13 \times I_e$ max.



Type	Rated operational current I_e [A]	Thermal release Adjustment range [A]	Magnetic release Operating current [A]	Switching of 3 phase AC motors, AC-2, AC-3						440/460V	
				3-phase [kW] (50/60Hz)			3-phase [HP] (60Hz)			I_{cu} [kA]	I_{cs} [kA]
				230V	400V	690V	230V	460V	575V		
GMS-32HI (High break)	0.16	-	2.1	-	0.02	-	-	-	-	100	100
	0.25	-	3.3	0.03	0.06	-	-	-	-	100	100
	0.4	-	5.2	0.06	0.09	-	-	-	-	100	100
	0.63	-	8.2	0.09	0.12	0.25	-	-	-	100	100
	1	-	13	0.12	0.25	0.55	-	1/2	1/2	100	100
	1.6	-	20.8	0.25	0.55	1.1	1/3	3/4	1	100	100
	2.5	-	32.5	0.37	0.75	1.5	1/2	1 1/2	1 1/2	100	100
	4	-	52	0.75	1.5	3	1	2	3	100	100
	6	-	78	1.5	2.2	4	1 1/2	5	5	100	100
	8	-	104	1.5	3	5.5	2	5	5	50	38
	10	-	130	3	4	7.5	3	7 1/2	10	50	38
	13	-	169	3	5.5	11	3	7 1/2	10	50	38
	17	-	221	4	7.5	11	5	10	15	20	15
	22	-	286	4	7.5	15	7 1/2	15	20	20	15
26	-	338	5.5	11	18.5	7 1/2	15	20	20	15	
32	-	416	7.5	15	22	10	20	30	20	15	
GMS-63HI (High break)	10	-	130	3	4	7.5	3	7 1/2	10	50	38
	13	-	169	3	5.5	11	3	7 1/2	10	50	38
	17	-	221	4	7.5	11	5	10	15	50	38
	22	-	286	4	7.5	15	7 1/2	15	20	50	38
	26	-	338	5.5	11	18.5	10	20	25	35	27
	32	-	416	7.5	15	22	10	25	30	35	27
	40	-	520	7.5	18.5	30	15	30	40	35	27
GMS-100HI (High break)	50	-	650	11	22	45	15	40	50	35	27
	63	-	819	15	30	55	20	50	60	35	27
	17	-	221	4	7.5	11	5	10	15	50	38
	22	-	286	4	7.5	15	7 1/2	15	20	50	38
	26	-	338	5.5	11	18.5	10	20	25	50	38
	32	-	416	7.5	15	22	10	25	30	50	38
	40	-	520	7.5	18.5	30	15	30	40	50	38
	50	-	650	11	22	45	15	40	50	50	38
	63	-	819	15	30	55	20	50	60	50	38
	75	-	975	22	37	63	25	60	75	50	38
GMS-100HI (High break)	90	-	1170	30	45	75	30	75	100	50	38
	100	-	1300	30	45	90	40	75	100	50	38







Motor protection ... Class 20

- Adjustable thermal release
- Magnetic release $13 \times I_e$ max.
- Trip class 20
- Ambient temperature compensation
- Phase-failure protection

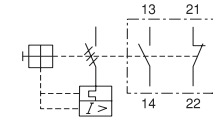
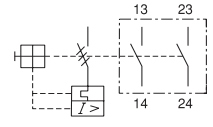
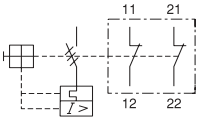

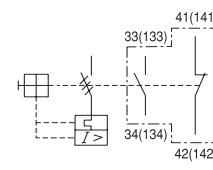
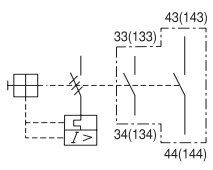
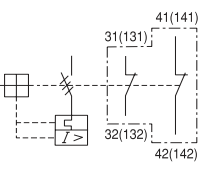

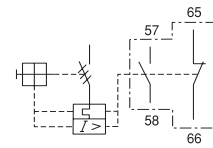
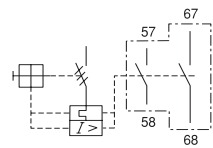
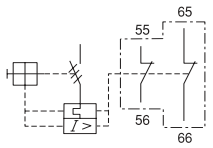

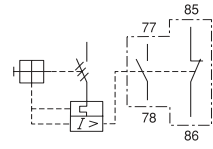
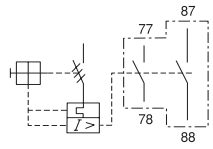
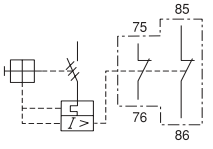
Type	Rated operational current I_e [A]	Thermal release Adjustment range [A]	Magnetic release Operating current [A]	Switching of 3 phase AC motors, AC-2, AC-3						440/460V	
				3-phase [kW] (50/60Hz)			3-phase [HP] (60Hz)			I_{cu} [kA]	I_{cs} [kA]
				230V	400V	690V	230V	460V	575V		
GMS-63HL (High break)	10	6~10	130	3	4	7.5	3	7 1/2	10	50	38
	13	9~13	169	3	5.5	11	3	7 1/2	10	50	38
	17	11~17	221	4	7.5	11	5	10	15	50	38
	22	14~22	286	4	7.5	15	7 1/2	15	20	50	38
	26	18~26	338	5.5	11	18.5	10	20	25	35	27
	32	22~32	416	7.5	15	22	10	25	30	35	27
	40	28~40	520	7.5	18.5	30	15	30	40	35	27
	50	34~50	650	11	22	45	15	40	50	35	27
GMS-100HL (High break)	63	45~63	819	15	30	55	20	50	60	35	27
	17	11~17	221	4	7.5	11	5	10	15	50	38
	22	14~22	286	4	7.5	15	7 1/2	15	20	50	38
	26	18~26	338	5.5	11	18.5	10	20	25	50	38
	32	22~32	416	7.5	15	22	10	25	30	50	38
	40	28~40	520	7.5	18.5	30	15	30	40	50	38
	50	34~50	650	11	22	45	15	40	50	50	38
	63	45~63	819	15	30	55	20	50	60	50	38
	75	55~75	975	22	37	63	25	60	75	50	38
	90	70~90	1170	30	45	75	30	75	100	50	38
100	80~100	1300	30	45	90	40	75	100	50	38	



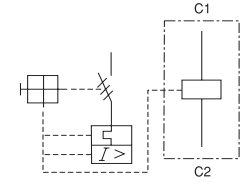

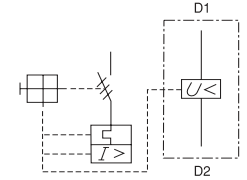
Type	Description	Connection diagram		
GFX... 	Auxiliary Switch · Front mounting · 2-pole · One front mounting module per circuit breaker	1NO1NC  GFX-11	2NO  GFX-20	2NC  GFX-02
GSX... 	Auxiliary Switch · Side mounting on the left · 2-pole · One side mounting module per circuit breaker	1NO1NC  GSX-11	2NO  GSX-20	2NC  GSX-02
GSA... 	Any Trip Alarm Switch · Side mounting on the left · 2-pole · One side mounting module per circuit breaker. (Always directly fitted to the circuit breaker).	 GSA32-11 GSA63100-11	 GSA32-20 GSA63100-20	 GSA32-02 GSA63100-02
GMA... 	Magnetic Trip Alarm Switch · Side mounting on the left · 2-pole · One side mounting module per circuit breaker. (Always directly fitted to the circuit breaker except using with Any Trip Alarm Switch).	 GMA-11	 GMA-20	 GMA-02

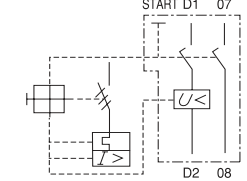
Ordering Example: Specify Contact Arrangement
 GFX-11 (1NO 1NC)
 GFX-20 (2NO)
 GFX-02 (2NC)

Type	Description	Connection diagram	
GSR... 	Shunt release · Side mounting on the right · One side mounting module per circuit breaker. (Always directly fitted to the circuit breaker).		24V 50Hz / 28V 60Hz 110~127V 50Hz / 120V 60Hz 220~230V 50Hz / 240~260V 60Hz 240V 50Hz / 277V 60Hz 380~400V 50Hz / 440~460V 60Hz 415~440V 50Hz / 460~480V 60Hz
GUR... 	Undervoltage release · Side mounting on the right · One side mounting module per circuit breaker. (Always directly fitted to the circuit breaker).		24V 50Hz / 28V 60Hz 110~127V 50Hz / 120V 60Hz 220~230V 50Hz / 240~260V 60Hz 240V 50Hz / 277V 60Hz 380~400V 50Hz / 440~460V 60Hz 415~440V 50Hz / 460~480V 60Hz
GURX... 	Undervoltage release with Switch (Rotary Handle Only) · Side mounting on the right · Include 2NO Auxiliary contact · One side mounting module per circuit breaker. (Always directly fitted to the circuit breaker).		24V 50Hz / 28V 60Hz 110~127V 50Hz / 120V 60Hz 220~230V 50Hz / 240~260V 60Hz 240V 50Hz / 277V 60Hz 380~400V 50Hz / 440~460V 60Hz 415~440V 50Hz / 460~480V 60Hz

Others

Type	Description	Applied Type
PIL32 	Push-in lug · For screwing the MMS on to mounting plates.	GMS-32S GMS-32H
IB100 	Insulation barriers · Insulation barriers with increased creepage distances and clearances for UL	GMS-100S GMS-100H

Busbar accessories



	45mm Spacing (rated 63A)	54mm Spacing (rated 63A)	63mm Spacing (rated 63A)	54mm Spacing (rated 120A)	63mm Spacing (rated 120A)	Terminal cover	Supply connector	Connection module
Type	GAVG45-14-2ABK	GAVG54-14-2ABK	GAVG63-14-2ABK	GAVCPM25412	GAVCPM26312	GAVB54	GAVGE1-14-25BK	GDA16SA
Description	For 2 GMS-32S/H	For 2 GMS-32S/H + accessories (side mnt aux sw)	For 2 GMS-32S/H + accessories (side mnt undervoltage or shunt trip)	For 2 GMS-63	For 2 GMS-63 + accessories (side mnt aux sw)	3 Pole protective cover for GAVG....	3 Phase input terminal 63A	For connecting GMS-32S to CGMS-6A - CGMS-12A
Type	GAVG45-14-3ABK	GAVG54-14-3ABK	GAVG63-14-3ABK	GAVCPM35412	GAVCPM36312	GAVTA120	GAVBTC50E	GDA16SD
Description	For 3 GMS-32S/H	For 3 GMS-32S/H + accessories (side mnt aux. sw)	For 3 GMS-32S/H + accessories (side mnt undervoltage or shunt trip)	For 3 GMS-63	For 3 GMS-63 + accessories (side mnt aux. sw)	3 Pole protective cover for GAVCPM..	3 Phase Input terminal 120A	For connecting GMS-32S to CGMS-6D - CGMS-12D
Type	GAVG45-14-4ABK	GAVG54-14-4ABK	GAVG63-14-4ABK	GAVCPM45412	GAVCPM46312			GDA16HA
Description	For 4 GMS-32S/H	For 4 GMS-32S/H + accessories (side mnt aux. sw)	For 4 GMS-32S/H + accessories (side mnt undervoltage or shunt trip)	For 4 GMS-63	For 4 GMS-63 + accessories (side mnt aux. sw)			For connecting GMS-32H to CGMS-6A - CGMS-12A
Type	GAVG45-14-5ABK	GAVG54-14-5ABK	GAVG63-14-5ABK					GDA16HD
Description	For 5 GMS-32S/H	For 5 GMS-32S/H + accessories (side mnt aux. sw)	For 5 GMS-32S/H + accessories (side mnt undervoltage or shunt trip)					For connecting GMS-32H to CGMS-6D - CGMS-12D



● GMS-100S

Rated operational current I _e [A]	17	22	26	32	40	50	63	75	90	100
Switching of standard three-phase motors										
AC-2, AC-3										
230/240V [kW]	3,7/4	4	5,5	7,5	7,5	11	15	22	30	30
400/415V [kW]	7,5	7,5	11	15	18,5	22	30	37	45	45
500V [kW]	11	11	15	18,5	22	30	37	45	55	63
690V [kW]	11	15	18,5	22	30	45	55	63	75	90
Back-up fuses										
gG, gL, only if I _{cc} >I _{cu} (* = No back up fuse required)										
230/240V [A]	*	*	*	*	*	*	*	*	*	*
400/415V [A]	100	125	125	125	160	160	160	160	160	160
440/460V [A]	100	125	125	125	125	160	160	160	160	160
500V [A]	100	100	100	100	100	100	100	125	125	125
690V [A]	63	80	80	80	80	80	80	100	125	125
Ultimate short-circuit breaking capacity I_{cu}										
230/240V [kA]	100	100	100	100	100	100	100	100	100	100
400/415V [kA]	50	50	50	50	50	50	50	50	50	50
440/460V [kA]	40	40	40	40	40	40	40	40	40	40
500V [kA]	25	25	25	15	15	12	12	8	8	8
690V [kA]	10	10	10	10	6	6	6	5	5	5
Rated service short-circuit breaking capacity I_{cs}										
230/240V [kA]	100	100	100	100	100	100	100	100	100	100
400/415V [kA]	38	38	38	38	38	38	38	38	38	38
440/460V [kA]	30	30	30	30	30	30	30	30	30	30
500V [kA]	19	19	19	11	11	9	9	6	6	6
690V [kA]	8	8	8	8	5	5	5	4	4	4



● GMS-100H

Rated operational current I _e [A]	17	22	26	32	40	50	63	75	90	100
Switching of standard three-phase motors										
AC-2, AC-3										
230/240V [kW]	3,7/4	4	5,5	7,5	7,5	11	15	22	30	30
400/415V [kW]	7,5	7,5	11	15	18,5	22	30	37	45	45
500V [kW]	11	11	15	18,5	22	30	37	45	55	63
690V [kW]	11	15	18,5	22	30	45	55	63	75	90
Back-up fuses										
gG, gL, only if I _{cc} >I _{cu} (* = No back up fuse required)										
230/240V [A]	*	*	*	*	*	*	*	*	*	*
400/415V [A]	*	*	*	*	*	*	*	*	*	*
440/460V [A]	125	125	125	160	160	160	200	200	200	200
500V [A]	100	125	125	125	160	160	160	160	160	160
690V [A]	80	80	80	80	80	100	100	125	160	160
Ultimate short-circuit breaking capacity I_{cu}										
230/240V [kA]	100	100	100	100	100	100	100	100	100	100
400/415V [kA]	100	100	100	100	100	100	100	75	75	75
440/460V [kA]	50	50	50	50	50	50	50	50	50	50
500V [kA]	35	35	35	25	20	15	15	12	12	12
690V [kA]	12	12	12	12	10	8	6	6	6	6
Rated service short-circuit breaking capacity I_{cs}										
230/240V [kA]	100	100	100	100	100	100	100	100	100	100
400/415V [kA]	100	50	50	50	50	50	50	50	50	50
440/460V [kA]	38	38	38	38	38	38	38	38	38	38
500V [kA]	27	27	27	19	15	11	11	9	9	9
690V [kA]	9	9	9	9	9	8	6	6	6	6

Note) * = Short circuit proof up to 50 or 100kA.
No back up fuse required.

● GMS-32HI

Rated operational current I _e [A]	0.16	0.25	0.4	0.63	1	1.6	2.5	4	6	8	10	13	17	22	26	32
AC-2, AC-3																
230/240V [kW]	-	0.03	0.06	0.09	0.12	0.18/0.25	0.37	0.55/0.75	1.1/1.5	1.5	2.2/3	3	3.7/4	4	5.5	7.5
400/415V [kW]	0.02	0.06	0.09	0.12	0.18/0.25	0.37/0.55	0.75	1.1/1.5	2.2	3	3.7/4	5.5	7.5	11	15	18.5
500V [kW]	-	-	-	0.25	0.37	0.55/0.75	1.1	1.5/2.2	3	3.7	4.5/5	7.5	11	11	15	18.5
690V [kW]	-	-	-	0.25	0.37/0.55	0.75/1.1	1.5	2.2/3	3.7/4	5.5	7.5	11	11	15	18.5	22
Back-up fuses																
gG, gL, only if I _{cc} >I _{cu} (* = No back up fuse required)																
230/240V [A]	*	*	*	*	*	*	*	*	*	*	*	*	*	*	*	*
400/415V [A]	*	*	*	*	*	*	*	*	*	*	*	*	*	100	125	125
440/460V [A]	*	*	*	*	*	*	*	*	*	*	*	*	*	80	80	100
500V [A]	*	*	*	*	*	*	*	*	*	*	*	*	*	63	80	80
690V [A]	*	*	*	*	*	*	35	40	50	63	63	63	63	63	63	63
Ultimate short-circuit breaking capacity I_{cu}																
230/240V [kA]	100	100	100	100	100	100	100	100	100	100	100	100	100	100	100	100
400/415V [kA]	100	100	100	100	100	100	100	100	100	100	100	100	100	100	100	100
440/460V [kA]	100	100	100	100	100	100	100	100	100	100	100	100	100	50	50	50
500V [kA]	100	100	100	100	100	100	100	100	100	100	100	100	100	50	50	20
690V [kA]	100	100	100	100	100	100	100	100	100	100	100	100	100	50	50	10
Rated service short-circuit breaking capacity I_{cs}																
230/240V [kA]	100	100	100	100	100	100	100	100	100	100	100	100	100	100	100	100
400/415V [kA]	100	100	100	100	100	100	100	100	100	100	100	100	100	38	38	38
440/460V [kA]	100	100	100	100	100	100	100	100	100	100	100	100	100	38	38	15
500V [kA]	100	100	100	100	100	100	100	100	100	100	100	100	100	38	38	8
690V [kA]	100	100	100	100	100	100	100	100	100	100	100	100	100	6	6	4

● GMS-63HI

Rated operational current I _e [A]	10	13	17	22	26	32	40	50	63
AC-2, AC-3									
230/240V [kW]	2,2/3	3	3,7/4	4	5,5	7,5	7,5	11	15
400/415V [kW]	3,7/4	5,5	7,5	7,5	11	15	18,5	22	30
500V [kW]	4,5/5	7,5	11	11	15	18,5	22	30	37
690V [kW]	7,5	11	11	15	18,5	22	30	45	55
Back-up fuses									
gG, gL, only if I _{cc} >I _{cu} (* = No back up fuse required)									
230/240V [A]	*	*	*	*	*	*	*	*	*
400/415V [A]	*	*	100	125	125	125	160	160	160
440/460V [A]	100	100	100	125	125	125	125	125	160
500V [A]	100	100	100	100	100	100	100	100	100
690V [A]	63	63	63	80	80	80	80	80	80
Ultimate short-circuit breaking capacity I_{cu}									
230/240V [kA]	100	100	100	100	100	100	100	100	100
400/415V [kA]	100	100	50	50	50	50	50	50	50
440/460V [kA]	50	50	50	50	35	35	35	35	35
500V [kA]	50	42	12	12	12	10	10	10	10
690V [kA]	6	6	5	5	5	5	5	5	5
Rated service short-circuit breaking capacity I_{cs}									
230/240V [kA]	100	100	100	100	100	100	100	100	100
400/415V [kA]	100	100	50	50	50	50	50	50	50
440/460V [kA]	38	38	38	38	27	27	27	27	27
500V [kA]	38	32	9	9	9	8	8	8	8
690V [kA]	5	5	5	5	5	5	5	5	5

● GMS-100HI

Rated operational current I _e [A]	17	22	26	32	40	50	63	75	90	100
AC-2, AC-3										
230/240V [kW]	3,7/4	4	5,5	7,5	7,5	11	15	22	30	30
400/415V [kW]	7,5	7,5	11	15	18,5	22	30	37	45	45
500V [kW]	11	11	15	18,5	22	30	37	45	55	63
690V [kW]	11	15	18,5	22	30	45	55	63	75	90
Back-up fuses										
gG, gL, only if I _{cc} >I _{cu} (* = No back up fuse required)										
230/240V [A]	*	*	*	*	*	*	*	*	*	*
400/415V [A]	*	*	*	*	*	*	*	*	*	*
440/460V [A]	125	125	125	160	160	160	200	200	200	200
500V [A]	100	125	125	125	160	160	160	160	160	160
690V [A]	80	80	80	80	80	100	100	125	160	160
Ultimate short-circuit breaking capacity I_{cu}										
230/240V [kA]	100	100	100	100	100	100	100	100	100	100
400/415V [kA]	100	100	100	100	100	100	100	75	75	75
440/460V [kA]	50	50	50	50	50	50	50	50	50	50
500V [kA]	35	35	35	25	20	15	15	12	12	12
690V [kA]	12	12	12	12	12	10	8	6	6	6
Rated service short-circuit breaking capacity I_{cs}										
230/240V [kA]	100	100	100							



IEC performance data (Motor protection ; Class 20)

UL/CSA performance data (Motor protection)



● GMS-63HL

Rated operational current I _e [A]		10	13	17	22	26	32	40	50	63
Switching of standard three-phase motors										
AC-2, AC-3										
230/240V [kW]		2.2/3	3	3.7/4	4	5.5	7.5	7.5	11	15
400/415V [kW]		3.7/4	5.5	7.5	7.5	11	15	18.5	22	30
500V [kW]		4/5.5	7.5	11	11	15	18.5	22	30	37
690V [kW]		7.5	11	11	15	18.5	22	30	45	55
Back-up fuses										
gG, gL, only if I _{cc} > I _{cu} (* = No back up fuse required)										
230/240V [A]		*	*	*	*	*	*	*	*	*
400/415V [A]		*	*	100	125	125	125	160	160	160
440/460V [A]		100	100	100	125	125	125	125	125	160
500V [A]		100	100	100	100	100	100	100	100	100
690V [A]		63	63	63	80	80	80	80	80	80
Ultimate short-circuit breaking capacity I_{cu}										
230/240V [kA]		100	100	100	100	100	100	100	100	100
400/415V [kA]		100	100	50	50	50	50	50	50	50
440/460V [kA]		50	50	50	50	35	35	35	35	35
500V [kA]		50	42	12	12	12	10	10	10	10
690V [kA]		6	6	5	5	5	5	5	5	5
Rated service short-circuit breaking capacity I_{cs}										
230/240V [kA]		100	100	100	100	100	100	100	100	100
400/415V [kA]		100	100	50	50	50	50	50	50	50
440/460V [kA]		38	38	38	38	27	27	27	27	27
500V [kA]		38	32	9	9	9	8	8	8	8
690V [kA]		5	5	5	5	5	5	5	5	5

● GMS-100HL

Rated operational current I _e [A]		17	22	26	32	40	50	63	75	90	100
Switching of standard three-phase motors											
AC-2, AC-3											
230/240V [kW]		3.7/4	4	5.5	7.5	7.5	11	15	22	30	30
400/415V [kW]		7.5	7.5	11	15	18.5	22	30	37	45	45
500V [kW]		11	11	15	18.5	22	30	37	45	55	63
690V [kW]		11	15	18.5	22	30	45	55	63	75	90
Back-up fuses											
gG, gL, only if I _{cc} > I _{cu} (* = No back up fuse required)											
230/240V [A]		*	*	*	*	*	*	*	*	*	*
400/415V [A]		*	*	*	*	*	*	*	*	*	*
440/460V [A]		125	125	125	160	160	160	200	200	200	200
500V [A]		100	125	125	125	160	160	160	160	160	160
690V [A]		80	80	80	80	80	100	100	125	160	160
Ultimate short-circuit breaking capacity I_{cu}											
230/240V [kA]		100	100	100	100	100	100	100	100	100	100
400/415V [kA]		100	100	100	100	100	100	100	75	75	75
440/460V [kA]		50	50	50	50	50	50	50	50	50	50
500V [kA]		35	35	35	25	20	15	15	12	12	12
690V [kA]		12	12	12	12	12	10	8	6	6	6
Rated service short-circuit breaking capacity I_{cs}											
230/240V [kA]		100	100	100	100	100	100	100	100	100	100
400/415V [kA]		100	50	50	50	50	50	50	50	50	50
440/460V [kA]		38	38	38	38	38	38	38	38	38	38
500V [kA]		27	27	27	19	15	11	11	9	9	9
690V [kA]		9	9	9	9	9	8	6	6	6	6

Note) * = Short circuit proof up to 50 or 100kA.
No back up fuse required.

Manual motor controller

(UL 508, CSA C22.2 as Manual motor controllers)

● GMS-32S

Rated operational current I _e [A]		0.16	0.25	0.4	0.63	1	1.6	2.5	4	6	8	10	13	17	22	26	32
Max. short-circuit current																	
240V [kA]		100	100	100	100	100	100	100	100	100	100	50	50	40	30	30	20
480Y/277V [kA]		50	50	50	50	50	50	50	50	25	25	10	10	10	10	7.5	7.5
600Y/347V [kA]		10	10	10	10	10	10	10	5	5	5	5	5	5	5	5	5
Motor load																	
1 Phase	115V [HP]	-	-	-	-	-	-	-	1/8	1/4	1/3	1/2	1/2	1	2	2	2
	230V [HP]	-	-	-	-	-	1/10	1/6	1/3	3/4	1	1½	2	3	3	5	5
3 Phase	230V [HP]	-	-	-	-	-	1/3	1/2	1	1½	2	3	3	5	7½	7½	10
	460V [HP]	-	-	-	-	1/2	3/4	1½	2	5	5	7½	7½	10	15	15	20
	575V [HP]	-	-	-	-	1/2	1	1½	3	5	5	10	10	15	20	20	30
Maximum rated current of fuse or breaker																	
[A]		500	500	500	500	500	500	500	500	500	500	500	500	500	500	500	500

Manual motor controller "group installation" or "Type E starter"

(UL 508, CSA C22.2 No..14, for group installation, in connection with a short-circuit protection device)

● GMS-32H

Rated operational current I _e [A]		0.16	0.25	0.4	0.63	1	1.6	2.5	4	6	8	10	13	17	22	26	32
Max. short-circuit current																	
240V [kA]		100	100	100	100	100	100	100	100	100	100	100	100	100	100	100	100
480Y/277V [kA]		65	65	65	65	65	65	65	65	65	65	65	65	30	30	30	30
600Y/347V [kA]		25	25	25	25	25	25	25	25	25	25	25	25	10	10	10	10
Motor load																	
1 Phase	115V [HP]	-	-	-	-	-	-	-	1/8	1/4	1/3	1/2	1/2	1	2	2	2
	230V [HP]	-	-	-	-	-	1/10	1/6	1/3	3/4	1	1½	2	3	3	5	5
3 Phase	230V [HP]	-	-	-	-	-	1/3	1/2	1	1½	2	3	3	5	7½	7½	10
	460V [HP]	-	-	-	-	1/2	3/4	1½	2	5	5	7½	7½	10	15	15	20
	575V [HP]	-	-	-	-	1/2	1	1½	3	5	5	10	10	15	20	20	30
Maximum rated current of fuse or breaker																	
[A]		500	500	500	500	500	500	500	500	500	500	500	500	500	500	500	500



Specifications are subject to change without notice.



UL/CSA performance data (Motor protection)

Manual motor controller "group installation" or "Type E starter"
(UL 508, CSA C22.2 No.14, for group installation, in connection with a short-circuit protection device)



● GMS-63S

Rated operational current I _e [A]		10	13	17	22	26	32	40	50	63
Max. short-circuit current										
240V [kA]		100	100	100	100	100	100	100	100	100
480Y/277V [kA]		50	50	40	40	40	40	40	40	40
600Y/347V [kA]		10	10	10	10	10	10	10	10	10
Motor load										
1 Phase 115V [HP]		1/2	1/2	1	2	2	3	3	5	5
230V [HP]		1½	2	3	3	5	5	7½	10	15
3 Phase 230V [HP]		3	3	5	7½	10	10	15	15	20
460V [HP]		7½	7½	10	15	20	25	30	40	50
575V [HP]		10	10	15	20	25	30	40	50	60
Maximum rated current of fuse or breaker [A]		600	600	600	600	600	600	600	600	600



● GMS-63H

Rated operational current I _e [A]		10	13	17	22	26	32	40	50	63
Max. short-circuit current										
240V [kA]		100	100	100	100	100	100	100	100	100
480Y/277V [kA]		65	65	50	50	50	50	50	50	50
600Y/347V [kA]		25	25	10	10	10	10	10	10	10
Motor load										
1 Phase 115V [HP]		1/2	1/2	1	2	2	3	3	5	5
230V [HP]		1½	2	3	3	5	5	7½	10	15
3 Phase 230V [HP]		3	3	5	7½	10	10	15	15	20
460V [HP]		7½	7½	10	15	20	25	30	40	50
575V [HP]		10	10	15	20	25	30	40	50	60
Maximum rated current of fuse or breaker [A]		600	600	600	600	600	600	600	600	600

Manual motor controller "group installation" or "Type E starter"
(UL 508, CSA C22.2 No.14, for group installation, in connection with a short-circuit protection device)



● GMS-100S

Rated operational current I _e [A]		17	22	26	32	40	50	63	75	90	100
Max. short-circuit current											
240V [kA]		100	100	100	100	100	100	100	100	100	100
480Y/277V [kA]		50	50	50	50	50	50	40	40	40	40
600Y/347V [kA]		10	10	10	10	10	10	10	10	10	10
Motor load											
1 Phase 115V [HP]		1	1½	2	3	3	5	5	7½	10	10
230V [HP]		3	3	5	5	7½	10	15	15	20	20
3 Phase 230V [HP]		5	7½	10	10	15	15	20	25	30	40
460V [HP]		10	15	20	25	30	40	50	60	75	75
575V [HP]		15	20	25	30	40	50	60	75	100	100
Maximum rated current of fuse or breaker [A]		1000	1000	1000	1000	1000	1000	1000	1000	1000	1000



● GMS-100H

Rated operational current I _e [A]		17	22	26	32	40	50	63	75	90	100
Max. short-circuit current											
240V [kA]		100	100	100	100	100	100	100	100	100	100
480Y/277V [kA]		65	65	65	65	65	65	50	50	50	50
600Y/347V [kA]		25	20	20	20	20	20	10	10	10	10
Motor load											
1 Phase 115V [HP]		1	1½	2	3	3	5	5	7½	10	10
230V [HP]		3	3	5	5	7½	10	15	15	20	20
3 Phase 230V [HP]		5	7½	10	10	15	15	20	25	30	40
460V [HP]		10	15	20	25	30	40	50	60	75	75
575V [HP]		15	20	25	30	40	50	60	75	100	100
Maximum rated current of fuse or breaker [A]		1000	1000	1000	1000	1000	1000	1000	1000	1000	1000

Manual Motor Controller (UL508)



● GMS-32S

Rated operational current I _e [A]		0.16	0.25	0.4	0.63	1	1.6	2.5	4	6	8	10	13	17	22	26	32
Max. short-circuit current																	
240V	[kA]	100	100	100	100	100	100	100	100	100	100	50	50	40	30	30	20
480Y/277V	[kA]	50	50	50	50	50	50	50	50	25	25	10	10	10	10	7.5	7.5
600Y/347V	[kA]	10	10	10	10	10	10	10	5	5	5	5	5	5	5	5	5
Motor load																	
1 Phase	115V [HP]	-	-	-	-	-	-	-	1/8	1/4	1/3	1/2	1/2	1	2	2	2
	230V [HP]	-	-	-	-	-	1/10	1/6	1/3	3/4	1	1½	2	3	3	5	5
3 Phase	230V [HP]	-	-	-	-	-	1/3	1/2	1	1½	2	3	3	5	7½	7½	10
	460V [HP]	-	-	-	-	1/2	3/4	1½	2	5	5	7½	7½	10	15	15	20
	575V [HP]	-	-	-	-	1/2	1	1½	3	5	5	10	10	15	20	20	30
Max. fuse size	[A]	1	1	1	1	3	6	10	15	20	30	40	50	60	80	100	125
Max. breaker size	[A]	15	15	15	15	15	15	15	15	20	30	40	50	60	80	100	125



● GMS-32H

Rated operational current I _e [A]		0.16	0.25	0.4	0.63	1	1.6	2.5	4	6	8	10	13	17	22	26	32
Max. short-circuit current																	
240V	[kA]	100	100	100	100	100	100	100	100	100	100	100	100	100	100	100	100
480Y/277V	[kA]	50	50	50	50	50	50	50	50	50	50	50	50	30	30	30	30
600Y/347V	[kA]	10	10	10	10	10	10	10	10	10	10	10	10	10	10	10	10
Motor load																	
1 Phase	115V [HP]	-	-	-	-	-	-	-	1/8	1/4	1/3	1/2	1/2	1	2	2	2
	230V [HP]	-	-	-	-	-	1/10	1/6	1/3	3/4	1	1½	2	3	3	5	5
3 Phase	230V [HP]	-	-	-	-	-	1/3	1/2	1	1½	2	3	3	5	7½	7½	10
	460V [HP]	-	-	-	-	1/2	3/4	1½	2	5	5	7½	7½	10	15	15	20
	575V [HP]	-	-	-	-	1/2	1	1½	3	5	5	10	10	15	20	20	30
Max. fuse size	[A]	1	1	1	1	3	6	10	15	20	30	40	50	60	80	100	125
Max. breaker size	[A]	15	15	15	15	15	15	15	15	20	30	40	50	60	80	100	125



● GMS-63S

Rated operational current I _e [A]		10	13	17	22	26	32	40	50	63
Max. short-circuit current										
240V	[kA]	100	100	100	100	100	100	100	100	100
480Y/277V	[kA]	25	25	25	25	25	25	25	25	25
600Y/347V	[kA]	10	10	10	10	10	10	10	10	10
Motor load										
1 Phase	115V [HP]	1/2	1/2	1	2	2	3	3	5	5
	230V [HP]	1½	2	3	3	5	5	7½	10	15
3 Phase	230V [HP]	3	3	5	7½	10	10	15	15	20
	460V [HP]	7½	7½	10	15	20	25	30	40	50
	575V [HP]	10	10	15	20	25	30	40	50	60
Max. fuse size	[A]	40	50	60	80	100	125	150	200	250
Max. breaker size	[A]	40	50	60	80	100	125	150	200	250



● GMS-63H

Rated operational current I _e [A]		10	13	17	22	26	32	40	50	63
Max. short-circuit current										
240V	[kA]	100	100	100	100	100	100	100	100	100
480Y/277V	[kA]	50	50	50	50	50	50	50	50	50
600Y/347V	[kA]	10	10	10	10	10	10	10	10	10
Motor load										
1 Phase	115V [HP]	1/2	1/2	1	2	2	3	3	5	5
	230V [HP]	1½	2	3	3	5	5	7½	10	15
3 Phase	230V [HP]	3	3	5	7½	10	10	15	15	20
	460V [HP]	7½	7½	10	15	20	25	30	40	50
	575V [HP]	10	10	15	20	25	30	40	50	60
Max. fuse size	[A]	40	50	60	80	100	125	150	200	250
Max. breaker size	[A]	40	50	60	80	100	125	150	200	250

● GMS-100S

Rated operational current I _e [A]		17	22	26	32	40	50	63	75	90	100
Max. short-circuit current											
240V	[kA]	100	100	100	100	100	100	100	100	100	100
480Y/277V	[kA]	25	25	25	25	25	25	25	25	25	25
600Y/347V	[kA]	10	10	10	10	10	10	10	10	10	10
Motor load											
1 Phase	115V [HP]	1	1½	2	3	3	5	5	7½	10	10
	230V [HP]	3	3	5	5	7½	10	15	15	20	20
3 Phase	230V [HP]	5	7½	10	10	15	15	20	25	30	40
	460V [HP]	10	15	20	25	30	40	50	60	75	75
	575V [HP]	15	20	25	30	40	50	60	75	100	100
Max. fuse size	[A]	60	80	100	125	150	200	250	300	350	400
Max. breaker size	[A]	60	80	100	125	150	200	250	300	350	400

● GMS-100H

Rated operational current I _e [A]		17	22	26	32	40	50	63	75	90	100
Max. short-circuit current											
240V	[kA]	100	100	100	100	100	100	100	100	100	100
480Y/277V	[kA]	50	50	50	50	50	50	50	50	50	50
600Y/347V	[kA]	10	10	10	10	10	10	10	10	10	10
Motor load											
1 Phase	115V [HP]	1	1½	2	3	3	5	5	7½	10	10
	230V [HP]	3	3	5	5	7½	10	15	15	20	20
3 Phase	230V [HP]	5	7½	10	10	15	15	20	25	30	40
	460V [HP]	10	15	20	25	30	40	50	60	75	75
	575V [HP]	15	20	25	30	40	50	60	75	100	100
Max. fuse size	[A]	60	80	100	125	150	200	250	300	350	400
Max. breaker size	[A]	60	80	100	125	150	200	250	300	350	400



Type	GMS-32S	GMS-32H	GMS-63S, 63H	GMS-100S, 100H
Rated insulation voltage				
IEC	690V	690V	1000V	1000V
UL, CSA	600V	600V	600V	600V
Rated impulse withstand voltage				
Uimp/Pollution degree	6kV / 3	6kV / 3	8kV / 3	8kV / 3
Rated frequency	50 / 60 Hz	50 / 60 Hz	50 / 60 Hz	50 / 60 Hz
Utilization category:				
IEC 947-2 (Circuit breaker)	Cat. A	Cat. A	Cat. A	Cat. A
IEC 947-4-1 (Motor starter)	AC 3	AC 3	AC 3	AC 3
Life span				
Mechanical Operations	100,000	100,000	50,000	50,000
Electrical(Ie max.) Operations	100,000	100,000	25,000	25,000
Switching frequency Ope./h	25	25	25	25
Ambient temperature				
Storage °C	-50 ~ +80	-50 ~ +80	-50 ~ +80	-50 ~ +80
Operation °C	-20 ~ +60	-20 ~ +60	-20 ~ +60	-20 ~ +60
Operation altitude m	Up to 2000 (6500 Feet)	Up to 2000 (6500 Feet)	Up to 2000 (6500 Feet)	Up to 2000 (6500 Feet)
Protection class	IP 20 Safe from finger touch	IP 20 Safe from finger touch	IP 20 Safe from finger touch	IP 20 Safe from finger touch
Resistance to shock g	25	25	25	25
Resistance to vibration Hz	5 ~ 150	5 ~ 150	5 ~ 150	5 ~ 150
Rated thermal current Ith				
IEC [A]	0.1 ... 32	0.1 ... 32	6 ... 63	11 ... 100
up to 60°C ambient temperature				
Overload protection				
Characteristics	○	○	○	○
Ambient temperature compensation, thermal current Ith adjustments				
-20°C ~ -5°C	set one point lower ³⁾	set one point lower ³⁾	set one point lower ³⁾	set one point lower ³⁾
-5°C ~ +40°C	automatic	automatic	automatic	automatic
+40°C ~ +60°C	set one point higher ³⁾	set one point higher ³⁾	set one point higher ³⁾	set one point higher ³⁾
Phase-failure protection	○	○	○	○
Trip class IEC 60947-4-1	10	10	10 ¹⁾	10 ¹⁾
Magnetic release				
Response current	13 × In ²⁾	13 × In ²⁾	13 × In ²⁾	13 × In ²⁾
Total power loss Pv				
Circuit breaker at rated load [W]	In = 0.16~4A : 9.8	In = 0.16~4A : 9.8	In = 10~22A : 13.3	In = 17~63A : 11.9
Operating temperature	In = 6~26A : 8 In = 32A : 3.9	In = 6~26A : 8 In = 32A : 3.9	In = 26~63A : 12.6	In = 75~100A : 15

Note = 1) Class20; GMS-63HL, GMS-100HL
 2) In = Max. rated operational current Ie
 3) use Thermal Current dial to adjust accordingly



● Manual Motor Starter GMS-32...100

		GMS-32S	GMS-32H	GMS-32S, 63H	GMS-100S, 100H	
Conformity to standards		IEC60947 UL508, UL508 Type E				
Approvals		CE, UL				
Terminal parts						
Screwdriver						
Single-core	1.conductor	[mm] / [AWG]	1...10 / 18...8	1...10 / 18...8	0.75...35 / 18...2	2.5...70 / 12...2/0
	2.conductor	[mm] / [AWG]	1...6 / 18...10	1...6 / 18...10	0.75...25 / 18...4	2.5...50 / 12...1/0
Stranded	1.conductor	[mm] / [AWG]	1...6 / 18...10	1...6 / 18...10	0.75...35 / 18...2	2.5...70 / 12...2/0
	2.conductor	[mm] / [AWG]	1...6 / 18...10	1...6 / 18...10	0.75...25 / 18...4	2.5...50 / 12...1/0
Flexible	1.conductor	[mm] / [AWG]	1...6 / 18...10	1...6 / 18...10	0.75...25 / 18...4	2.5...50 / 12...1/0
	2.conductor	[mm] / [AWG]	0.75...4 / 18...10	0.75...4 / 18...10	0.75...16 / 18...6	2.5...35 / 10...2
Tightening torque		[Nm] / [lb-in]	0.8...2.5 / 7...22	0.8...2.5 / 7...22	3...4.5 / 26...39	4...6 / 35...53

● Accessories for Manual Motor Starter GMS-32...100

		Auxiliary contacts for front mounting GFX...		Auxiliary contacts for left side mounting GSX...		Alarm switch for left side mounting GSA...	
Rated thermal current / th							
at 40°C ambient temperature	[A]	5		1 0		1 0	
at 60°C ambient temperature	[A]	3		6		6	
Contact class coordination according to NEMA (UL/CSA-Standards)							
AC		B 600 Standard Pilot Duty		A 600 Standard Pilot Duty		A 600 Standard Pilot Duty	
DC		R 300 Light Pilot Duty		Q 300 Light Pilot Duty		Q 300 Light Pilot Duty	
Back-up fuses gG, gL		[A]		1 6		1 6	
Rated supply current		[V]		24 240		24 240	
AC-15:	[A]	3 2		6 4		6 4	
DC-13:	[V]	24 220		24 220		24 220	
	[A]	1 0.1		2 0.25		2 0.25	
Terminal parts							
Type of terminals							
Screwdriver				Pozidriv size 2			
Single-core	1.conductor	[mm] / [AWG]	0.5...2.5 / 20...14				
	2.conductor	[mm] / [AWG]	0.5...2.5 / 20...14				
Flexible	1.conductor	[mm] / [AWG]	0.5...4 / 20...10				
	2.conductor	[mm] / [AWG]	0.75...2.5 / 18...14				
Tightening torque		[Nm] / [lb-in]	0.8...1.2 / 7...10				

● Accessories for Manual Motor Starter GMS-32...100

	Undervoltage release for right side mounting GUR...	Undervoltage release with 2 auxiliary contacts for right side mounting GURX...	Shunt release for right side mounting GSR...
Actuating voltage			
Pull-in	0.85...1.1 × Us	0.85...1.1 × Us	0.7...1.1 × Us
Drop-out	0.7...0.35 × Us	0.7...0.35 × Us	
Rated control voltage			
min.:	24V 50Hz / 28V 60Hz	24V 50Hz / 28V 60Hz	24V 50Hz / 28V 60Hz
max.:	415~440V 50Hz / 460~480V 60Hz	415~440V 50Hz / 460~480V 60Hz	415~440V 50Hz / 460~480V 60Hz
Coil rating			
Pull-in	8.5VA, 6W	8.5VA, 6W	8.5VA, 6W
Hold	3VA, 1.2W	3VA, 1.2W	3VA, 1.2W
On-Time	100%	100%	100%
Terminal parts			
Type of terminals			
Screwdriver		Pozidriv size 2	
1.conductor	[mm] / [AWG]	0.5...2.5 / 20...14	
2.conductor	[mm] / [AWG]	0.5...2.5 / 20...14	
1.conductor	[mm] / [AWG]	0.5...4 / 20...10	
2.conductor	[mm] / [AWG]	0.75...2.5 / 18...14	
Tightening torque		[Nm] / [lb-in]	
		0.8...1.2 / 7...10	

● Weights

Description	Type	Weight [g]
Circuit breaker	GMS-32S	320
	GMS-32H	360
	GMS-63S	1,000
	GMS-100S	2,200
Auxiliary switch	GFX... (Front Auxiliary Switch)	18
	GSX... (Side Auxiliary Switch)	30
	GSA... (Alarm Switch)	40
Undervoltage release	GUR... (Undervoltage release)	110
	GURX... (Undervoltage release with 2 auxiliary contacts)	120
Shunt release	GSR... (Shunt release)	110



Type '2' coordination according to IEC 947-4-1

Time/Current characteristic

- Short-circuit current $I_q = 50kA$
Voltage : 400/415V, 50/60Hz

Standard motors AC-3 at 400/415V 1500rpm		Manual motor starter			Contactor	
[kW]	[A]	Circuit breaker Type	Thermal overload release setting range [A]	Magnetic release response current [A]	Type	[A]
0.06	0.24	GMS-32S 0.25A	0.16 ~0.25	3.25	CGMS-6	6
0.09	0.33	GMS-32S 0.4A	0.25~0.4	5.2	CGMS-6	6
0.12	0.43	GMS-32S 0.63A	0.4~0.63	8.19	CGMS-6	6
0.18	0.61	GMS-32S 0.63A	0.4~0.63	8.19	CGMS-6	6
0.25	0.8	GMS-32S 1A	0.63~1	13	CGMS-6	6
0.37	1.1	GMS-32S 1.6A	1~1.6	20.8	CGMS-6	6
0.55	1.5	GMS-32S 1.6A	1~1.6	20.8	CGMS-6	6
0.75	1.9	GMS-32S 2.5A	1.6~2.5	32.5	CGMS-9/CGC-9	9
1.1	2.7	GMS-32S 4A	2.5~4	52	CGMS-9/CGC-9	9
1.5	3.5	GMS-32S 4A	2.5~4	52	CGMS-12/CGC-12	12
2.2	5.0	GMS-32S 6A	4~6	78	CGC-18	18
3.0	6.6	GMS-32S 8A	5~8	104	CGC-18	18
4.0	8.5	GMS-32S 10A	6~10	130	CGC-18	18
5.5	11.0	GMS-32S 13A	9~13	169	CGC-22	22
7.5	15.0	GMS-32H 17A	11~17	221	CGC-22	22
10.0	20.0	GMS-32H 22A	14~22	286	CGC-32	32
11.0	22.0	GMS-32H 26A	18~26	338	CGC-32	32
15.0	29.0	GMS-32H 32A	22~32	416	CGC-32	32
18.5	36.0	GMS-63S 40A	28~40	520	CGC-50	50
22.0	41.0	GMS-63S 50A	34~50	650	CGC-50	50
30.0	56.0	GMS-63S 63A	45~63	819	CGC-65	65
37.0	68.0	GMS-100S 75A	55~75	975	CGC-75	75
-	-	GMS-100S 90A	70~90	1170	CGC-85	85
45.0	81.0	GMS-100S 100A	80~100	1300	CGC-85	85

Definition type '2' coordination according to IEC 947-4-1

- The contactor or the starter must not endanger persons or systems in the event of a short-circuit.
- The contactor or the starter must be suitable for further use.
- No damage to the overload relay or other parts may occur with the exception of welding of the contactor or starter contacts provided that these can be easily separated without significant deformation (such as with a screwdriver).

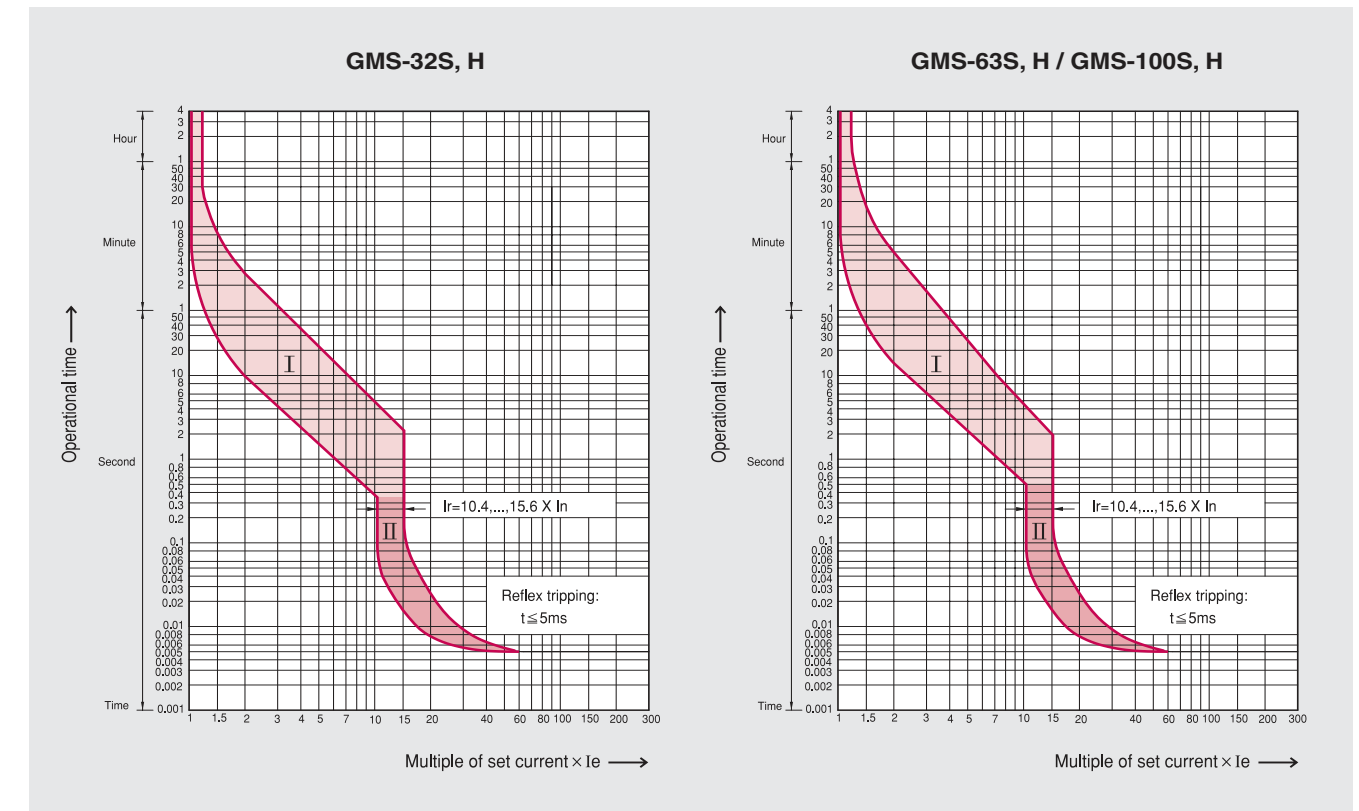

I) Thermal release trip current :

The adjustable inverse bimetal trip reliability protects motors against overloads. The curve shows the mean operating current at an ambient temperature of 20 °C starting from cold. Careful testing and setting ensures effective motor protection even in the case of single-phasing.

II) Magnetic release current :

The instantaneous magnetic trip has a fixed operating current setting. This corresponds to 13times the maximum value of setting range, at a lower setting it is correspondingly higher.

Current setting I_e :

The overload trip corresponds to a thermal overload relay in a motor starter conforming to IEC 947-4-1. If a different value is prescribed (e.g. reduced I_e for cooling medium having a temperature higher than 40 °C or a place of installation higher than 2000m above sea level), the setting current is equal to the reduced rated current I_e of the motor.

● GMS-32S

[mm]

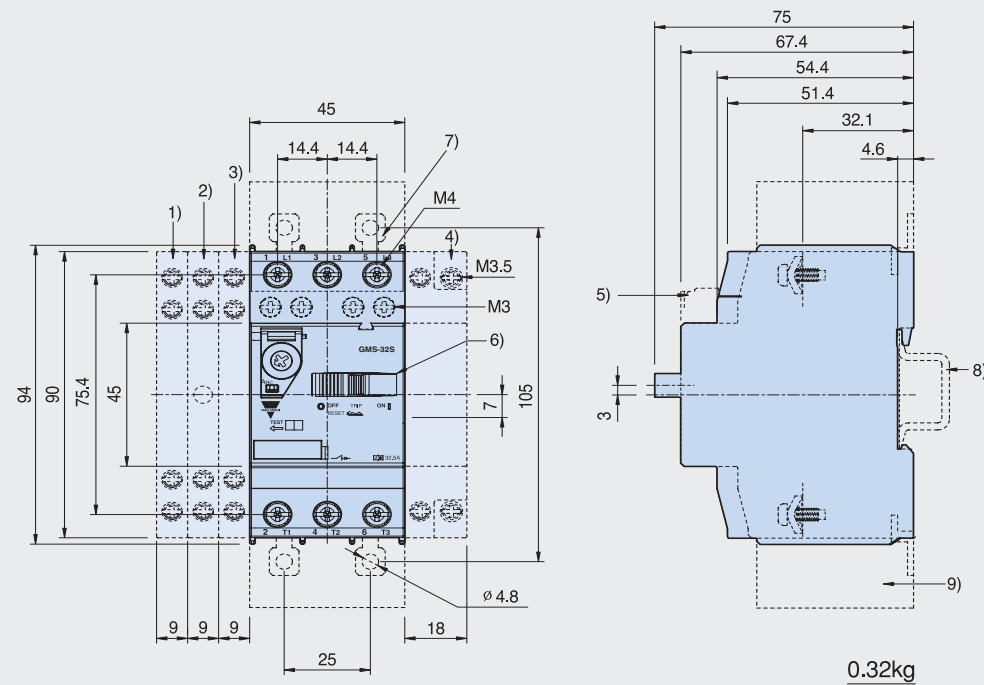

0.32kg

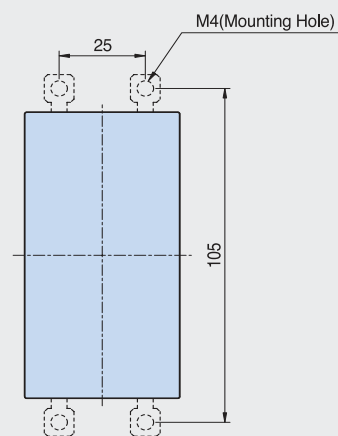

Height of arcing spaces
(Clearance from earthed parts)

Ue[V]	240	415	460	525	690
[mm]	20	20	20	20	20

Arcing spaces for limiter function

Ue[V]	525		690	
	left/right	top/bottom	left/right	top/bottom
[mm]	10	40	30	50

- 1) Side auxiliary switch
- 2) Side magnetic trip alarm switch
- 3) Side any trip alarm switch
- 4) Side shunt release or Side undervoltage release
- 5) Front auxiliary switch
- 6) Handle lock in OFF position(\varnothing 5mm)
- 7) Push-in Lugs for screw mounting
- 8) 35mm standard mounting rail acc. to EN 50 022
- 9) Arcing space

● GMS-32H, 32HI

[mm]

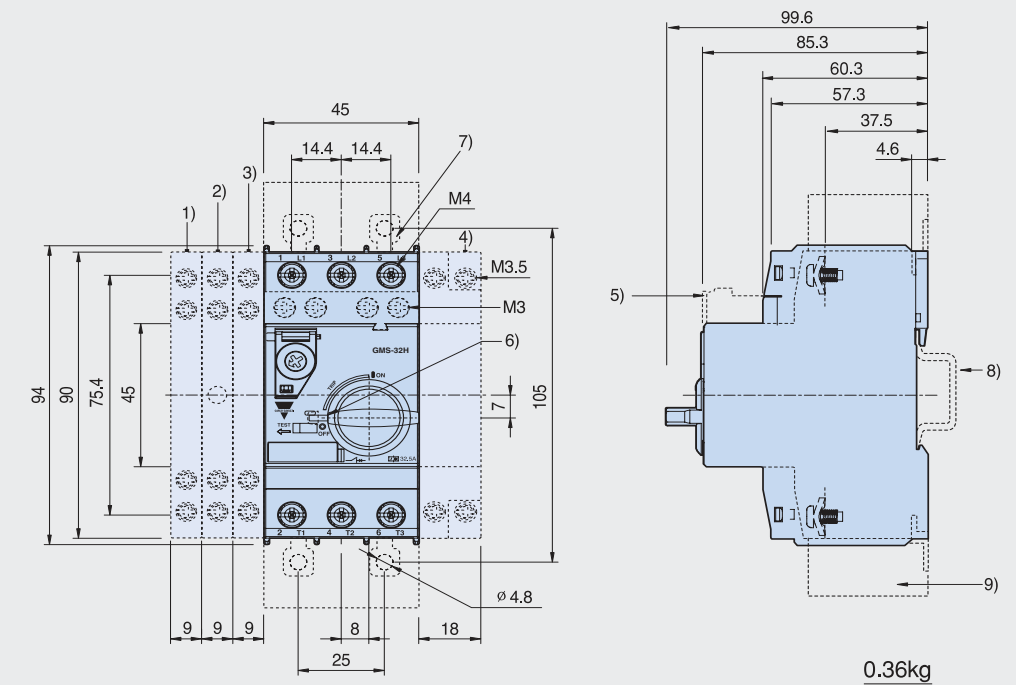

0.36kg

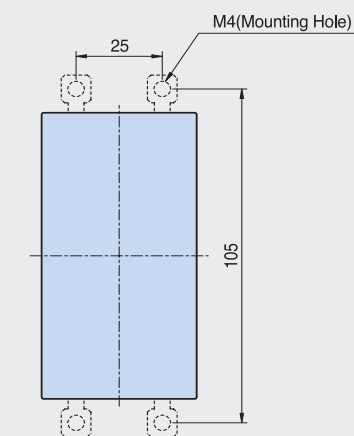

Height of arcing spaces
(Clearance from earthed parts)

Ue[V]	240	415	460	525	690
[mm]	30	30	30	30	50

Arcing spaces for limiter function

Ue[V]	525		690	
	left/right	top/bottom	left/right	top/bottom
[mm]	10	40	30	50

- 1) Side auxiliary switch
- 2) Side magnetic trip alarm switch
- 3) Side any trip alarm switch
- 4) Side shunt release or Side undervoltage release
- 5) Front auxiliary switch
- 6) Handle lock in OFF position(\varnothing 5mm)
- 7) Push-in Lugs for screw mounting
- 8) 35mm standard mounting rail acc. to EN 50 022
- 9) Arcing space

● GMS-63S, 63H, 63HI, 63HL

[mm]

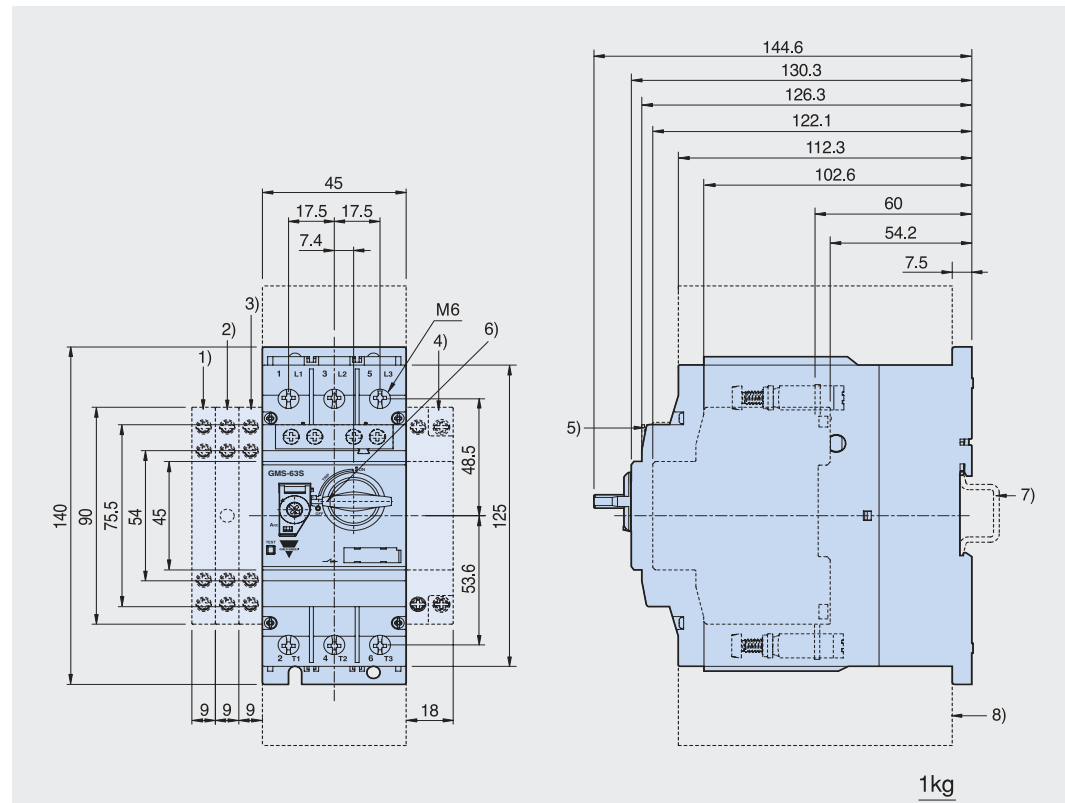

1kg

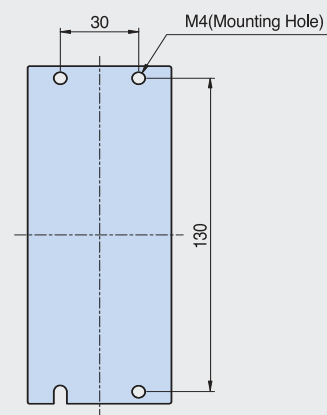

Height of arcing spaces
(Clearance from earthed parts)

Ue[V]	240	415	460	525	690
[mm]	50	50	50	50	50

Arcing spaces for limiter function

Ue[V]	525		690	
	left/right	top/bottom	left/right	top/bottom
[mm]	10	50	10	50

- 1) Side auxiliary switch
- 2) Side magnetic trip alarm switch
- 3) Side any trip alarm switch
- 4) Side shunt release or Side undervoltage release
- 5) Front auxiliary switch
- 6) Handle lock in OFF position(\varnothing 5mm)
- 7) 35mm standard mounting rail acc. to EN 50 022
- 8) Arcing space

● GMS-100S, 100H, 100HI, 100HL

[mm]

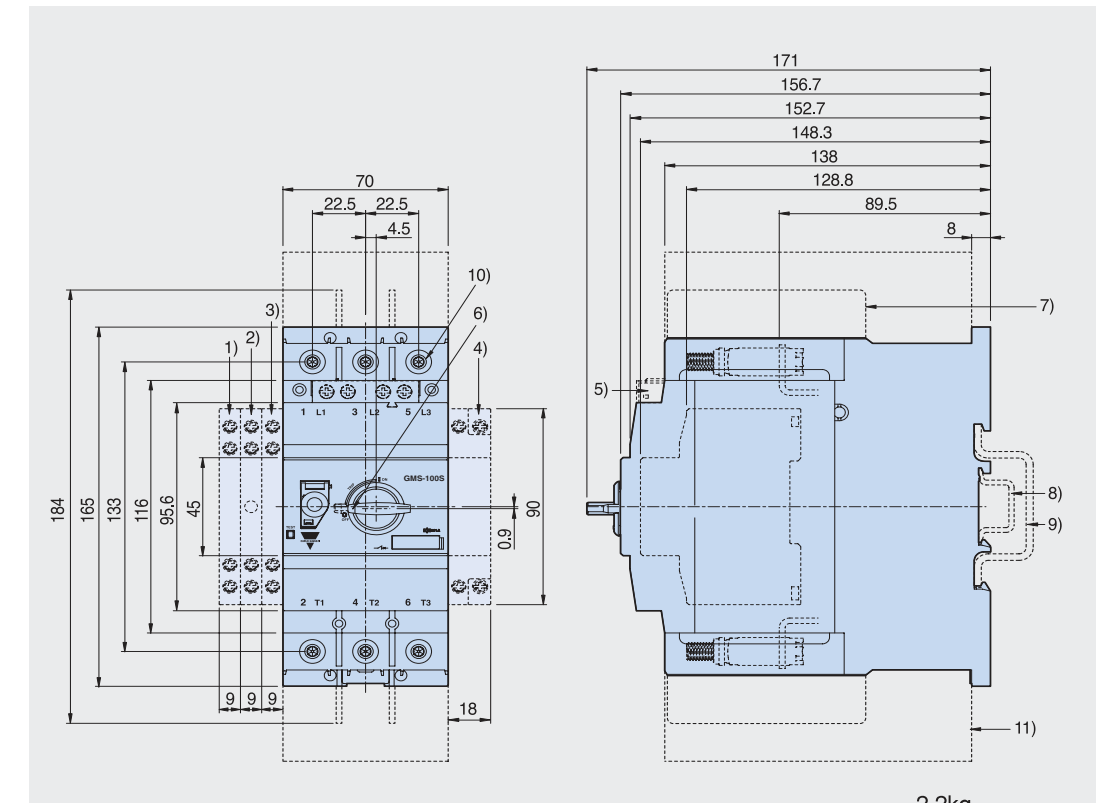

2.2kg

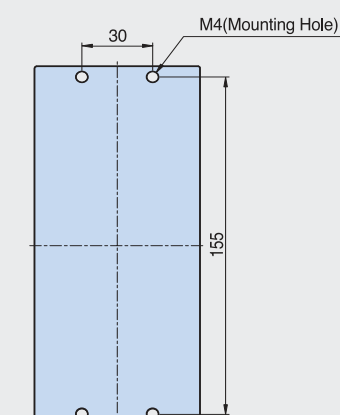

Height of arcing spaces
(Clearance from earthed parts)

Ue[V]	240	415	460	525	690
[mm]	50	70	70	110	150

Arcing spaces for limiter function

Ue[V]	525		690	
	left/right	top/bottom	left/right	top/bottom
[mm]	10	110	30	150

- 1) Side auxiliary switch
- 2) Side magnetic trip alarm switch
- 3) Side any trip alarm switch
- 4) Side shunt release or Side undervoltage release
- 5) Front auxiliary switch
- 6) Handle lock in OFF position(\varnothing 5mm)
- 7) Insulation barrier
- 8) 35mm standard mounting rail acc. to EN 50 022
- 9) 75mm standard mounting rail acc. to EN 50 023
- 10) 4mm hexagon socket screw
- 11) Arcing space



www.GavazziOnline.com

www.GavazziOnline.com is an information filled website which offers you the ability to download data sheets, specify products, check pricing and availability, track shipping and so much more:



Download Brochures



Easy-to-use Product Selection Guides



New Product Press Releases



Industry Specific Brochures/Flyers



Latest Events



Industry Specific Web Pages



Data Sheets

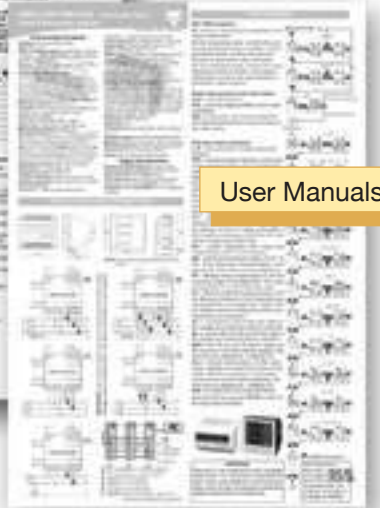

User Manuals

The Complete Product Package

Sensors

Inductive and Capacitive Sensors
Photoelectric Sensors
Ultrasonic Sensors
Wind Sensors
Radar Sensors
Motion/Presence Vision Sensors
Conductive Level Sensors
Magnetic Switches
Safety Interlocks and Light Curtains

Switches

Solid State Relays
Contactors and Overloads
Manual/Motor Starters/Protectors
Circuit and Motor Protection
Soft Starters
Variable Frequency Drives
Hybrid Relays
Electromechanical Relays
Limit Switches
Push Buttons and Pilot Lights

Controls

Energy Management
Switching Power Supplies
Timers and Counters
Monitoring Controls and CB
Human Machine Interfaces
Digital Panel Meters
PID Controllers
PV String Monitoring
Safety Control Modules
Solar Monitoring and Control

Fieldbuses

Dupline® Field and Installation Bus
Building Automation Systems
Parking Guidance Systems
Elevator Systems
DuplineSafe Mining Systems
Irrigation Systems

A Global Force in Industrial and Building Automation



USA
CARLO GAVAZZI INC.
750 Hastings Lane
Buffalo Grove, IL 60089
Tel: 847.465.6100
Fax: 800.222.2659
Sales@CarloGavazzi.com

CANADA
CARLO GAVAZZI (CANADA) INC.
2680 Meadowvale Boulevard
Mississauga, ON L6N 6M6
Tel: 888.575.2275
Fax: 905.542.2248
Gavazzi@CarloGavazzi.com

MEXICO
CARLO GAVAZZI MEXICO S.A. de C.V.
Calle La Montaña no. 28, Fracc. Los Pastores
Naucalpan de Juárez, EDOMEX CP 53340
Tel & Fax: 55.5373.7042
MexicoSales@CarloGavazzi.com

Regional / Area Sales Offices
District Sales Offices

CARLO GAVAZZI has a multitude of sales offices spanning North America (not to mention our hundreds of distributors). Therefore, we can be viewed as "your local automation resource" - assisting you every step of the way in finding the proper solution for your various application requirements. Naturally, our job is greatly simplified as we have such a vast range of solutions to offer you via our comprehensive product package. Our worldwide sales offices make us an ideal business partner, especially for manufacturers of exported machinery, as our products are available locally and they are RoHS and CE marked.

Argentina • Australia • Austria • Bahrain • Belgium • Bolivia • Bosnia • Brazil • Brunei • Bulgaria • Canada
Chile • China • Columbia • Croatia • Cyprus • Czech • Denmark • Dominican Republic • Egypt • Estonia
Finland • France • Germany • Greece • Hungary • Hong Kong • Iceland • India • Indonesia • Iran • Ireland
Italy • Japan • Jordan • Kenya • Korea • Kuwait • Lebanon • Malaysia • Malta • Morocco • Mauritius • Mexico
Netherlands • New Zealand • Norway • Pakistan • Papua New Guinea • Paraguay • Peru • Philippines
Poland • Portugal • Qatar • Romania • Russia • Saudi Arabia • Serbia • Singapore • Slovakia • Slovenia
South Africa • Spain • Sultanate of Oman • Sweden • Switzerland • Taiwan • Thailand • Tunisia • Turkey
Ukraine • United Arab Emirates • United Kingdom • Uruguay • United States • Venezuela • Vietnam • and many more countries

Your Authorized Distributor:

CARLO GAVAZZI
Automation Components

USA Tel: 847.465.6100 Fax: 800.222.2659

Canada Tel: 888.575.2275 Fax: 905.542.2248

Mexico Tel and Fax: 55.5373.7042

www.GavazziOnline.com • Info@CarloGavazzi.com

twitter.com/CarloGavazziNA facebook.com/CarloGavazziNA



Download our mobile app: **GAVAZZI APP**

