

承认书



SPECIFICATION FOR APPROVAL Switching power Supply/开关电源

客 户:

CUSTOMER: Sparkfun

产品描述:

DESCRIPTION: Input:100~240V AC 50/60Hz Output: 12VDC2A\5V2A

机种型号:

OUR MODEL NO: QX36D-2(Dual output)

样品编号:

日期:

SAMPLE NO: QX201800312-1

DATE: 2018-07-04

产品颜色:

SAMPLE COLOR: Black White

符合环保项: RoHS REACH PAHS 17P 加州 65

APPROVAL SIGNATURE/客户确认		
核准/APPROVED BY	审核/CHECKED BY	检测/TESTED BY
Manufacturer/制造商		
业务/SALES	核准/APPROVED BY	设计/DESIGNED BY
林里		

深圳市齐鑫电子有限公司

SHEN ZHEN QI XIN ELECTRONICS CO.,LTD

地址: 中国广东省深圳市宝安区福永镇重庆路新福工业园 A6 栋 3 楼

Add: Floor3, Buiding A6, Xinfu Industrial Zone, Chongqing Road, Fuyong Town,
Baoan District, Shenzhen, China.

Tel: 0755-29609342 81443738 Fax: 0755-29776652

<http://www.qshain.com.cn> E-mail: nick@qshain.com.cn



深圳市齐鑫电子有限公司
SHEN ZHEN QI XIN ELECTRONICS CO., LTD

型号/Our model: QX36D-2(Dual output)

客户/Customer: Sparkfun

日期/Date: 2018-07-04

样品编号/SAMPLE No: QX201800312-1

版本目录/Rev. List			
版本/Rev.	日期/Date	描述/Description	制订/Design
A0	2018-03-26	新版本/New Rev.	CM
A1	2018-07-04	修正 PCB 板	CM

Table of contents

1、描述/DESCRIPTION.....	3
2、输入特性/INPUT CHARACTERISTICS.....	3
3、输出特性/OUTPUT CHARACTERISTICS.....	4-5
4、保护功能/PROTECTION FUNCTION.....	5
5、环境要求/ENVIRONMENTAL REQUIREMET.....	5~6
6、安全及 EMI 要求/SAFETY AND EMC REQUIREMENT.....	6
7、结构参数/MECHANICAL REQUIREMENT.....	7
8、线材/CORD.....	8
9、铭牌附图/LABEL.....	9
10、包装说明/PACKING.....	10
11、测试报告/ELECTRICAL TEST REPORT.....	11

1、描述/ DESCRIPTION:

本规格书适应于 QX36W12V2A/5V2A 双输出型号的开关电源.

The purpose of the document is to specify the functional requirements of a 34W switching power supply.

2、输入特性/INPUT CHARACTERISTICS:

2.1 输入电压/Input Voltage:

额定电压/Rated Voltage: 100~240Vac

调整范围/Variation Range: 90-264Vac

2.2 输入频率/Input Frequency:

额定频率/ Rated Frequency: 50/60Hz.

调整频率/Variation Frequency: 47-63Hz

2.3 输入电流/Input Current:

当输入交流电压为额定值的下限电压负载满载时,最大输入交流电流 1.0A.

1.0Amps max At any input voltage and rated, DC output rated load.

2.4 浪涌电流/Inrush Current:

当输出为额定负载,环境温度为 25℃,输入 240Vac 冷态起机时无损坏.

No damage shall be occurred and the input fuse shall not be blown up, Cold start at 240Vac input, with rated load and 25℃ ambient.

2.5 AC 漏电流/Ac Leakage Current:

当输入电压 240Vac 时,最大漏电流为 0.25mA.

0.25mA Max. At 240Vac input.

3、输出特性/OUTPUT CHARACTERISTICS:

3.1 输出功率/Power output (AC:100~240V)

电压 Voltage	最小负载 Min. Load	额定负载 Rated. Load	峰值功率 Peak	输出功率 Output power
12VDC	0.01A	2A		24W
5VDC	0.01A	2A		10W

3.2 负载特性,调整率/Combined Load/Line Regulation (AC:100~240V)

电压 Voltage	最小负载 Min. Load	额定负载 Rated. Load	线性调整 Line Regulation	负载调整率 Load Regulation
12VDC	0.01A	2A	±2%	±5%
5VDC	0.01A	2A	±2%	±5%

3.3 纹波和噪音 Ripple and Noise:

测试条件:在输入 115/230Vac 和输出最小及最大负载时,使用示波器带宽为 20MHz 连接到适配器的输出端,同时输出端并联一个 47uF 的电解电容和一个 0.1uF 的瓷片电容.

At 115/230Vac input and output Min and Max.Load, the ripple and noise are as follows when measure with Max.Bandwidth of 20MHz and Parallel 47uF/0.1uF,crossed connected at testing point.

电压 Voltage	最大纹波/最大噪音 Ripple and Noise(Max.)
+12/5VDC	150mV p-p

3.4 启动延迟时间/Turn on delay time:

当输入 115Vac 和输出最大负载时,最大启动时间为 3S.

3Seconds Max.at 115Vac input and output Max.load.

3.5 上升时间/Rise time:

当输入 115Vac 和输出最大负载时最大时间为 40 mS.

40 mS Max.at 115Vac input and output Max load.

3.6 保持时间/Hold up time:

当输入 115Vac 和输出最大负载时,最小保持时间为 5 mS .

5 mS Min.at 115Vac input and output Max.Load.

3.7 过冲/Overshoot:

在电源开启或关闭的时候,最大 15%.

15% Max.When power supply at turn off/on.



深圳市齐鑫电子有限公司
SHEN ZHEN QI XIN ELECTRONICS CO., LTD

型号/Our model: QX36D-2(Dual output)

客户/Customer: Sparkfun

日期/Date: 2018-07-04

样品编号/SAMPLE No: QX201800312-1

3.8 待机功耗/Standby Power:

当输入 115Vac 60Hz 时 0.1W 最大 .

0.1W Max. at 115Vac 60Hz $I_o=0$ input.

3.9 效率/Efficiency:

当 115/230Vac 输入电压时, 1/4, 1/2, 3/4 和满载计算平均效率, 最小 82.54

82.54%, At 115/230Vac input voltage, 1/4, 1/2, 3/4 and full load calculation average efficiency.

适配器满足能效 VI。

Adapter meet efficiency level VI.

4、保护功能/PROTECTION FUNCTION:

4.1 短路测试/Short circuit test:

该电源供给器在短路解除时能正常工作恢复.

The power supply will be auto recovered when short circuit faults remove.

4.2 过流保护/Over current Protection:

过流故障排除后,电源将自动恢复正常工作.

The power supply will be auto recovered when over current faults remove.

5、环境要求/ENVIRONMENTAL REQUIREMET:

5.1 工作温度/Operating Temperature:

0°C-40°C,满载,正常工作.

0°C to 40°C, Full load, Normal operation.

5.2 储藏温度/Storage Temperature:-20°C to 60°C

带外壳/With package

5.3 工作湿度/Relative Humidity:

5%(0°C)~90%(40°C),72 小时,满载,正常工作.

5%(0°C)~90%(40°C)RH,72Hrs, Full load, Normal operating.

5.4 振动/Vibration:

1. 测试标准:国际电工电子委员会

Operating: IEC 721-3-3 3M3

5~9Hz, A=1.5mm

加速度(9~200Hz, Acceleration 5m/S²)

2. 运输/Transportation:

IEC 721-3-2 2M2

5-9Hz, A=3.5mm

9~200Hz, 加速度 Acceleration=5m/S²

200~500Hz, 加速度 Acceleration=15m/S²



深圳市齐鑫电子有限公司
SHEN ZHEN QI XIN ELECTRONICS CO., LTD

型号/Our model: QX36D-2(Dual output)

客户/Customer: Sparkfun

日期/Date: 2018-07-04

样品编号/SAMPLE No: QX201800312-1

3. 轴向振动/Axes, 10 cycles per axis.

在测试过程中不能出现永久性的损坏。

No permanent damage may occur during testing.

在电源开启和关闭后,样机能够恢复到最初条件.

The SAMPLE has to restore to its original situation after power off/on.

5.5 跌落试验/Dropping Packed:

跌落高度为 760mm;

Drop the height is 760mm.

测试台面是厚 13mm 的夹木板, 离地面高 19-20mm

The horizontal surface consists of hardwood at least 13mm thick, mounted on two layers of plywood each 19mm to 20mm thick, all supported on a concrete or equivalent non-resilient floor.

6、安全及 EMI 要求/SAFETY AND EMI REQUIREMENT:

6.1 安全:符合标准 EN60950

Safety: accord with EN60950

6.2 高压/DIELECTRIC STRENGTH Hi-Pot:

初级对次级/Primary to secondary: 4242Vdc/5mA/60S for type test.

6.3 绝缘阻抗/Insulation resistance:

初级对次级/Primary to secondary: 20M Ω min at 500V DC.

6.4 EMI 标准/EMI STANDARD

Meets the Limits of/测试符合

<1>.Fcc part15 class B rules

<2>.EN55032 class B rules

<3>. GB17625.1-2012

<4>.AS/NZS CISPR32:2015.

<5>.IEC61000-4-5

<6>.IEC61000-4-2



深圳市齐鑫电子有限公司
SHEN ZHEN QI XIN ELECTRONICS CO., LTD

型号/Our model: QX36D-2(Dual output)

客户/Customer: Sparkfun

日期/Date: 2018-07-04

样品编号/SAMPLE No: QX201800312-1

7、结构参数/MECHANICAL REQUIREMENT:

7.1 外壳/Enclosure:

The power supply size: L94x W47x H30mm;

外壳尺寸: L94x W47x H30mm;

7.2 输入线/Input Connector:

2PIN 插脚/Two pin input plug of 2PIN

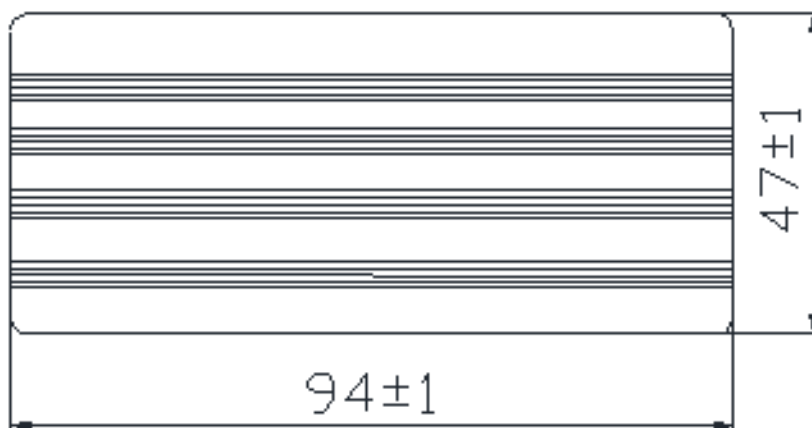
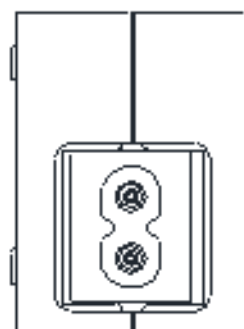
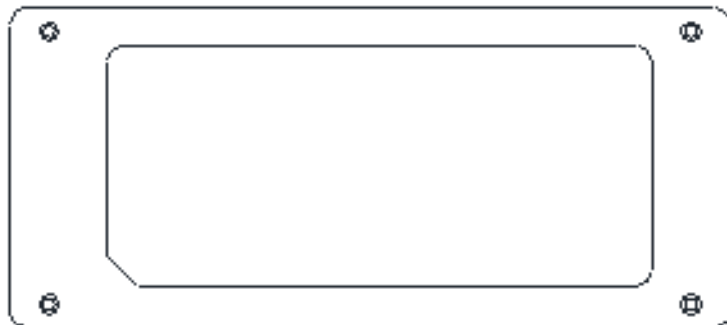
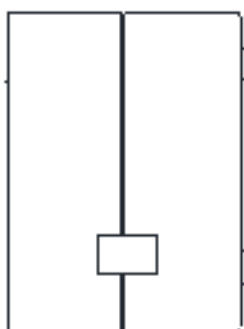

dimension(mm)

型号/Our model: QX36D-2(Dual output)
客户/Customer: Sparkfun
日期/Date: 2018-07-04
样品编号/SAMPLE No: QX201800312-1

8、线材/CORD:

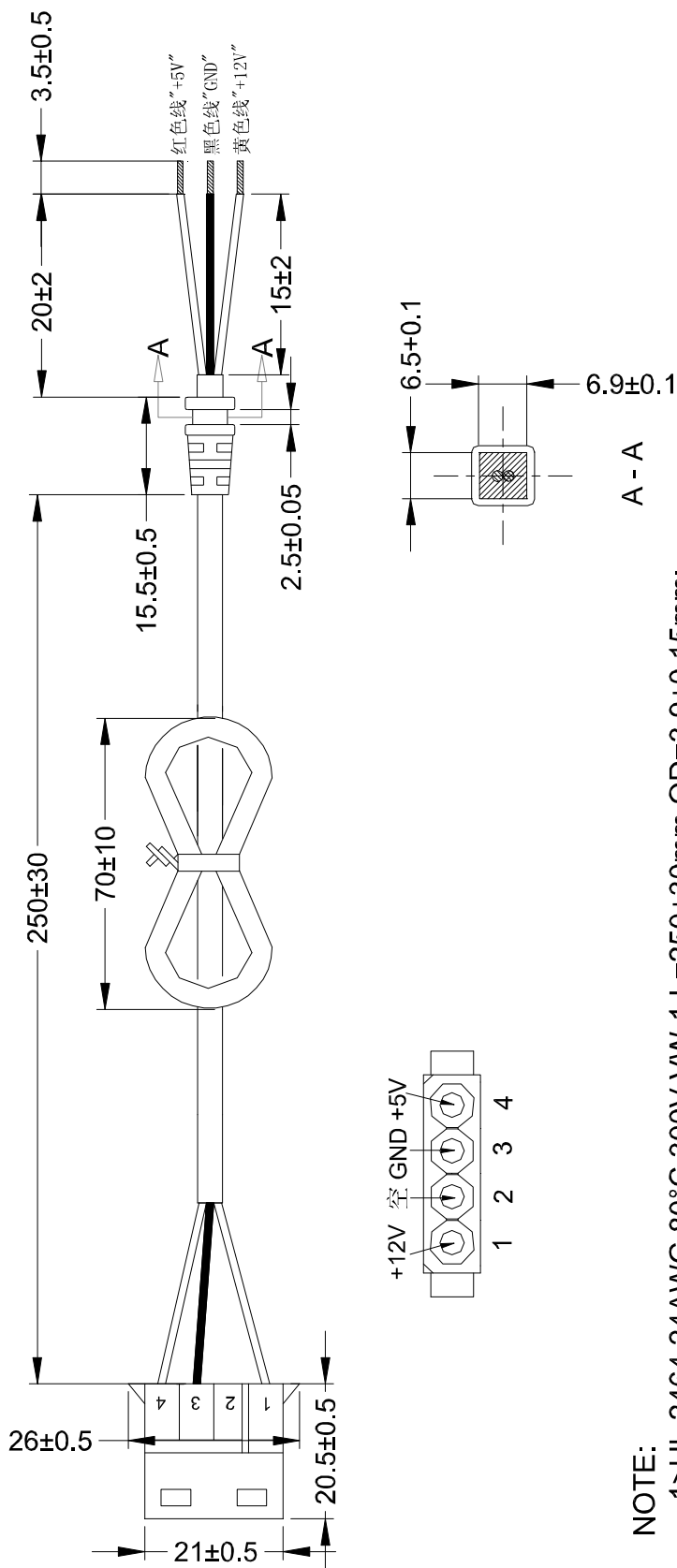

NOTE:

- 1>UL 2464 24AWG 80°C 300V VW-1 L=250±30mm, OD=3.9±0.15mm;
- 2>PLUG:Molex15-24-404B端子, 黄色线PIN1"+12V", PIN2空, 黑色线PIN3"GND", 红色线PIN4"+5V";
- 3>Color:Black;
- 4>RoHS2.0REACHPAHS\17P\加州65.
- 5>Material:线皮: PVC.线芯: 铜.

9、铭牌/LABEL:

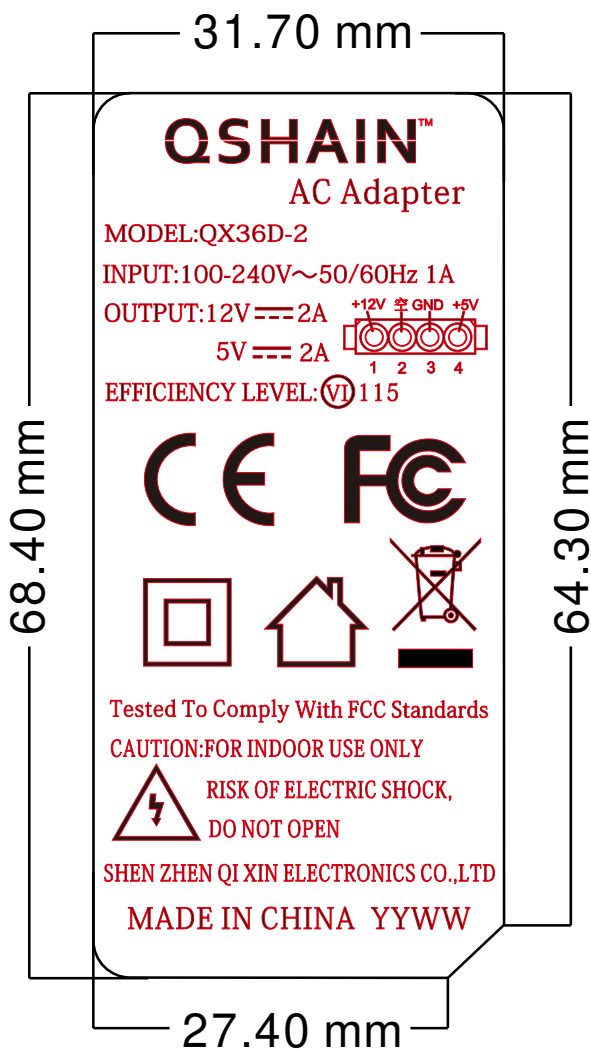

NOTES:

1. 激光丝印于外壳上
2. YYWW, YY 表示年份, WW 表示周数

10、包装说明/PACKING:

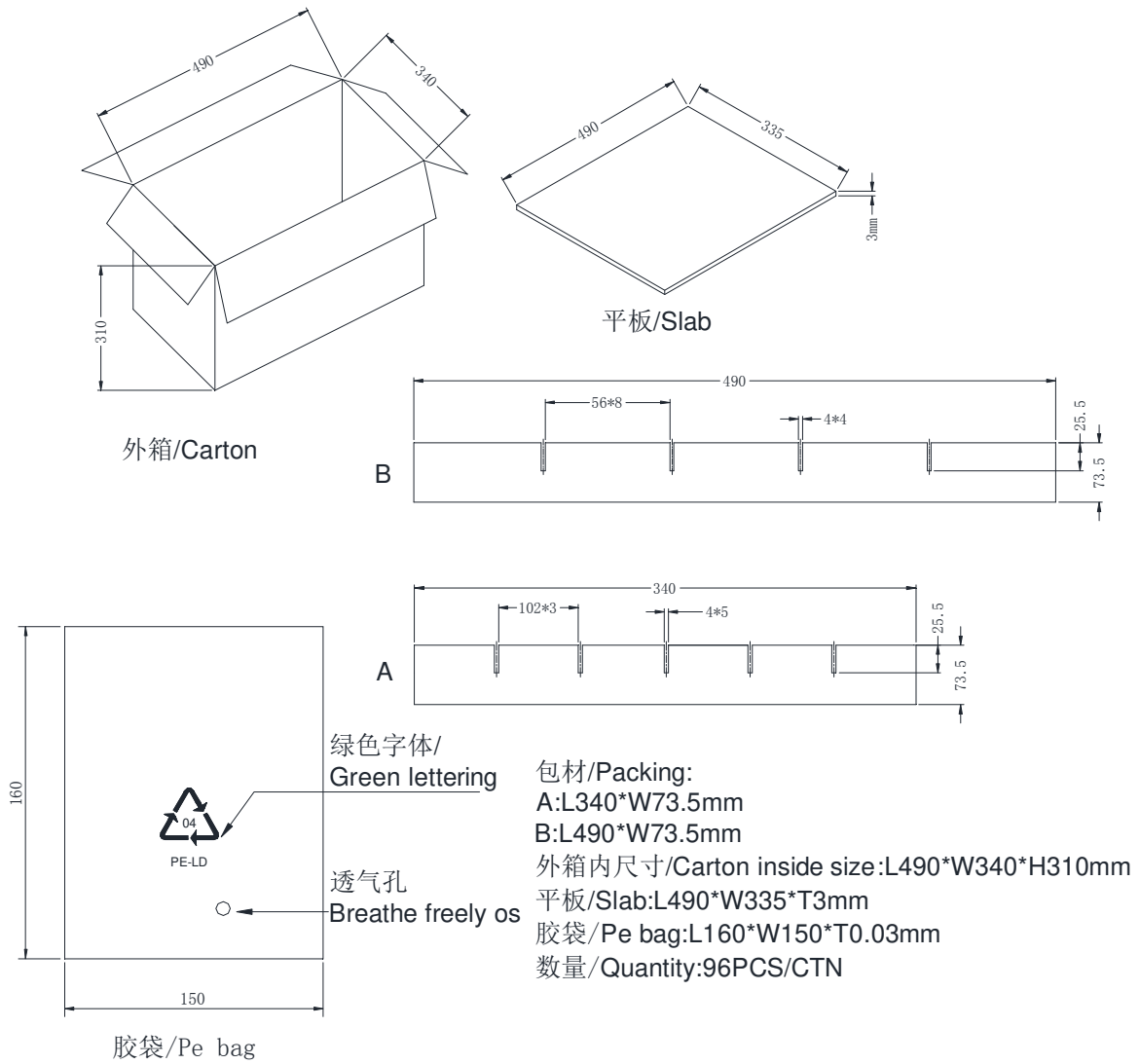

备注：此包装材料仅供参考。

11、 测试报告/ELECTRICAL TEST REPORT:

No 序号	Test item 测试项目	Test condition 测试条件	Standard spec 标准规格	Test data 测试数据					Unit 单位	Judge 判定
				12V2A	5V2A	3	4	5		
1	Output Voltage 输出电压	Vin100Vac 60Hz Io=0 输入 100Vac 空载	±5%	12.19	5.02				V	Pass
2	Output Voltage 输出电压	Vin100Vac 60HzIo=Rated Current 输入 100Vac 60Hz 负载	±5%	11.81	4.81				V	Pass
3	Average Efficiency 平均效率	Vin 115Vac 60Hz 输入 115Vac 60Hz	82.54%	84.45	84.40				%	Pass
4	Ripple&Noise mVp-p 纹波&杂讯	Vin100Vac 60Hz Full load 输入 100Vac 60Hz 满载	150mVp-p	22	24				mVp-p	Pass
5	Line Regulation 线性调整率	Vin=100V~240V Io=Rated Current 额定电流	±2%	OK	OK				/	Pass
6	Standby Power 待机功耗	Vin 115Vac 60Hz Io=0 输入 115Vac 60Hz	0.1W max	0.06	0.06				W	Pass
7	Short circuit test 短路测试	Vin100Vac 60Hz 输入 100Vac 空载	No odor smoke fire plastic deformation and excessive heat happen. 无冒烟,起火,外壳变 形及过热现象	OK	OK				/	Pass
8	OCP 过流保护	Vin 100Vac 60Hz 输入 100Vac	AMax	3.81	2.35				A	
9	Output Voltage 输出电压	Vin240Vac 50Hz Io=0 输入 240Vac 空载	±5%	12.19	5.02				V	Pass
10	Output Voltage 输出电压	Vin240Vac 50HzIo=Rated Current 输入 240Vac 60Hz 负载	±5%	11.81	4.81				V	Pass
11	Average Efficiency 平均效率	Vin230Vac 50Hz 输入 230Vac 50Hz	82.54%	83.16	83.10				%	Pass
12	Ripple & Noise mVp-p 纹波&杂讯	Vin240Vac 50Hz Full load 输入 240Vac 50Hz 额定电流	150mVp-p	26	25				mVp-p	Pass
13	Line Regulation 线性调整率	Vin=100V~240V Io=Rated Current 输入 100V~240V	±2%	OK	OK				/	Pass
14	Standby Power 待机功耗	Vin230Vac 50Hz Io=0 输入 230V 50Hz	W max	/	/				W	Pass
15	Short circuit test 短路测试	Vin240Vac 50Hz 输入 240Vac 50Hz	No odor smoke fire plastic deformation and excessive heat happen. 无冒烟,起火,外壳变 形及过热现象	OK	OK				/	Pass
16	OCP 过流保护	Vin 100Vac 60Hz 输入 100Vac	AMax	3.79	2.34				A	
17	Hi-pot test 高压测试	高压/DIELECTRIC STRENGTH Hi-Pot: 初级对次级 /Primary to secondary:4242Vdc/5mA/60S for type test		OK	OK				/	Pass
18	Burn in 老化	Input:220Vac/50Hz Full Load 4hrs 输入 220Vac/50Hz 满载 4 小时		OK	OK				/	Pass
19	Drop test 跌落	Heigh: 1m Three*faces(once on each plane) 高 1 米,3 个面,每面 1 次.		OK	OK				/	Pass
REMARK 备注										