



# ACE1501 Product Family Arithmetic Controller Engine (ACE<sup>TM</sup>) for Low Power Applications

## General Description

The ACE1501 (Arithmetic Controller Engine) family of microcontrollers is a dedicated programmable monolithic integrated circuit for applications requiring high performance, low power, and small size. It is a fully static part fabricated using CMOS technology.

The ACE1501 product family has an 8-bit microcontroller core, 64 bytes of RAM, 64 bytes of data EEPROM and 1K bytes of code EEPROM. Its on-chip peripherals include a multifunction 16-bit timer, a watchdog/idle timer, and programmable under-voltage detection circuitry. On-chip clock and reset functions reduce the number of required external components. The ACE1501 product family is available in 8- and 14-pin SOIC, TSSOP and DIP packages.

## Features

- Arithmetic Controller Engine
- 1K bytes on-board code EEPROM
- 64 bytes data EEPROM
- 64 bytes RAM
- Watchdog
- Multi-input wake-up on all eight general purpose I/O pins
- 16-bit multifunction timer with difference capture
- On-chip oscillator
  - No external components
  - 1µs instruction cycle time +/-2% accuracy
- Instruction set geared for block encryption
- On-chip Power-on Reset
- Programmable read and write disable functions
- Memory mapped I/O
- 32-level Low Voltage Detection
- Brown-out Reset
- Software selectable I/O option
  - Push-pull outputs with tri-state option
  - Weak pull-up or high impedance inputs
- Fully static CMOS
  - Low power HALT mode (100nA @ 2.7V)
  - Power saving IDLE mode
- Single supply operation
  - 1.8-3.6V
- 40 years data retention
- 1.8V data EEPROM min writing voltage
- 1,000,000 data changes
- 8- and 14-pin SOIC, TSSOP and DIP packages
- In-circuit programming

## Block and Connection Diagram

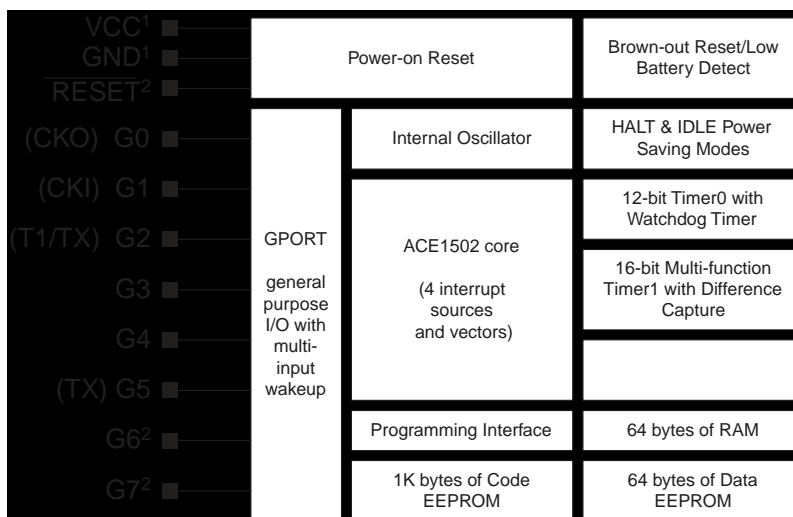

1. 100nf Decoupling capacitor recommended  
2. Available only in the 14-pin package option

Figure 2. ACEx Application Example (Remote Keyless Entry)

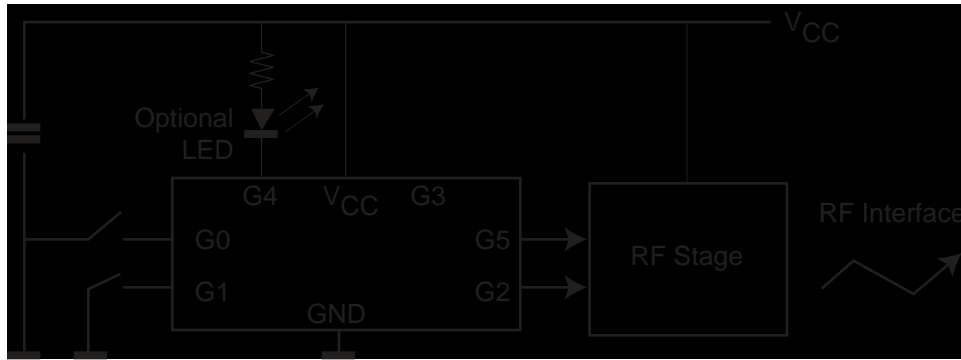
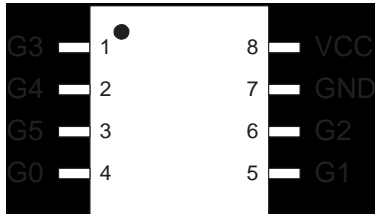

Figure 3. ACE1501 8-pin SOIC and DIP Device Pinout

a) Normal Mode Operation



b) Programming Mode Operation

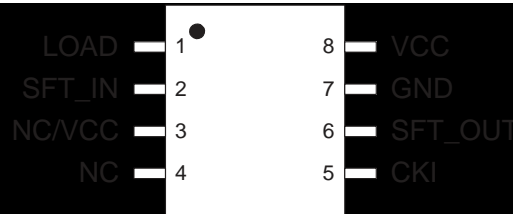
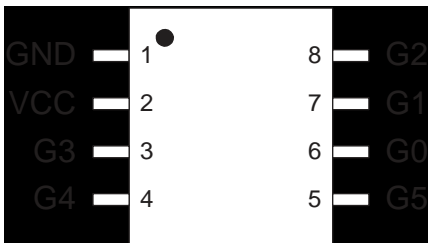

Figure 4. ACE1501 8-pin TSSOP Device Pinout

a) Normal Mode Operation



b) Programming Mode Operation

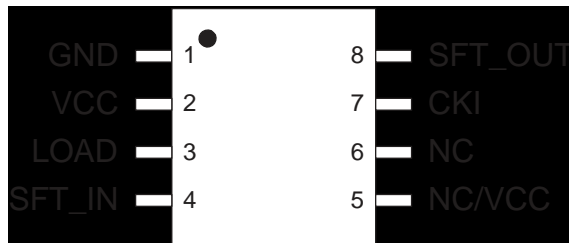
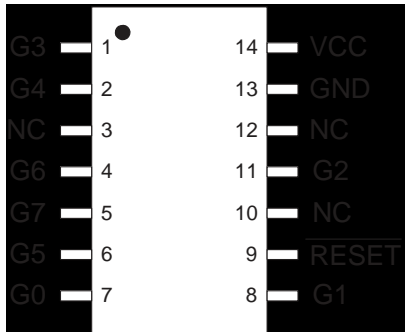
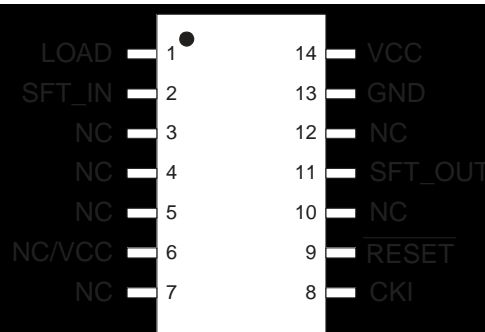

Figure 5. ACE1501 14-pin SOIC, TSSOP and DIP Device Pinout

a) Normal Mode Operation



b) Programming Mode Operation



## 2. Electrical Characteristics

### Absolute Maximum Ratings

Ambient Storage Temperature	-65 °C to +150 °C
Input Voltage	-0.3V to $V_{CC} + 0.3V$
Lead Temperature (10s max)	+300°C
Electrostatic Discharge on all pins	2000V min

### Operating Conditions

Relative Humidity (non-condensing)	95%
EEPROM write limits	See DC Electrical Characteristics

Part Number	Operating Voltage	Ambient Operating Temperature
ACE1501E	1.8 to 3.6V	-40°C to +85°C
ACE1501V	1.8 to 3.6V	-40°C to +125°C

### ACE1501 DC Electrical Characteristics, $V_{CC} = 1.8$ to $3.6V$

All measurements are valid for ambient operating temperature unless otherwise stated.

Symbol	Parameter	Conditions	MIN	TYP	MAX	Units
$I_{CC}^3$	Supply Current - no data EEPROM write in progress	1.8V		0.4	0.6	mA
		2.2V		0.4	0.6	mA
		2.7V		0.5	0.7	mA
		3.6V		0.6	1.0	mA
$I_{CC_H}$	HALT Mode current	2.7V @ 25°C			400	nA
		2.7V @ -40°C to +85°C		100	5000	nA
		3.6V @ 25°C			1000	nA
$I_{CC_L}^4$	IDLE Mode current	3.6V @ -40°C to +85°C		0.25	10	µA
		1.8V		210		µA
$V_{CC_W}$	EEPROM write voltage	Code EEPROM in Programming Mode	3.0	3.3	3.6	V
		Data EEPROM in Operating Mode	1.8		3.6	V
$S_{V_{CC}}$	Power Supply Slope		1µs/V		10ms/V	
$V_{IL}$	Input Low with Schmitt Trigger buffer	$V_{CC} = 2.2 - 3.6V$			0.2V <sub>CC</sub>	V
		$V_{CC} < 2.2V$			0.15V <sub>CC</sub>	V
$V_{IH}$	Input High with Schmitt Trigger buffer	$V_{CC} = 1.8 - 3.6V$	0.8V <sub>CC</sub>			V
$I_{IP}$	Input Pull-up Current	$V_{CC} = 3.6V, V_{IN} = 0V$	30	65	350	µA
$I_{TL}$	Tri-State Leakage	$V_{CC} = 3.6V$		2	200	nA
$V_{OL}$	Output Low Voltage: G0, G1, G2, G3, G4, G5, G6, G7	$V_{CC} = 1.8 - 2.7V$ 2 mA sink			0.2V <sub>CC</sub>	V
	Output Low Voltage: G0, G1, G2, G3, G4, G5, G6, G7	$V_{CC} = 3.3 - 3.6V$ 7.0 mA sink			0.2V <sub>CC</sub>	V
$V_{OH}$	Output High Voltage: G0, G1, G2, G3, G4, G5, G6, G7	$V_{CC} = 2.2 - 2.7V$ 2 mA source	0.8V <sub>CC</sub>			V
	Output High Voltage: G0, G1, G2, G3, G4, G5, G6, G7	$V_{CC} = 3.3 - 3.6V$ 7 mA source	0.8V <sub>CC</sub>			V

3.  $I_{CC}$  active current is dependant on the program code.

4. Based on a continuous IDLE looping program.

**ACE1501 AC Electrical Characteristics,  $V_{CC} = 1.8$  to  $3.6V$** 

All measurements are valid for ambient operating temperature unless otherwise stated.

Parameter	Conditions	MIN	TYP	MAX	Units
Instruction cycle time from internal clock - setpoint	3.3V at +25°C	0.98	1.0	1.02	μs
Internal clock frequency variation	1.8V to 3.6V at constant temperature		1.2		%
	1.8V to 3.6V at full temperature range (Note 6)			6	%
Crystal oscillator frequency	(Note 5)			25	MHz
External clock frequency	(Note 5)			8	MHz
EEPROM write time			5.5	10	ms
Internal clock start up time	(Note 6)			2	ms
Oscillator start up time	(Note 6)			2400	cycles

5. The maximum permissible frequency is guaranteed by design but is not 100% tested

6. The parameter is characterized but is not 100% tested, contact Fairchild for additional characterization data.

**ACE1501 Electrical Characteristics for programming**

All data valid at ambient temperature between 3.0V and 3.6V. The following characteristics are guaranteed by design but are not 100% tested. See "EEPROM write time" in the AC Electrical Characteristics for definition of the programming ready time.

Parameter	Description	MIN	MAX	Units
$t_{HI}$	CLOCK high time	500	DC	ns
$t_{LO}$	CLOCK low time	500	DC	ns
$t_{DIS}$	SHIFT_IN setup time	100		ns
$t_{DIH}$	SHIFT_IN hold time	100		ns
$t_{DOS}$	SHIFT_OUT setup time	100		ns
$t_{DOH}$	SHIFT_OUT hold time	900		ns
$T_{RESET}$	Power On Reset time	3.2	4.5	ms
$t_{LOAD1}, t_{LOAD2}, t_{LOAD3}, t_{LOAD4}$	LOAD timing	5		μs

**ACE1501 Low Battery Detect (LBD) Characteristics,  $V_{CC} = 1.8$  to  $3.6V$** 

Parameter	Conditions	MIN	TYP	MAX	Units
LBD voltage threshold variation	-40°C to +85°C	-5		+5	%

**ACE1501 Brown-out Reset (BOR) Characteristics,  $V_{CC} = 1.8$  to  $3.6V$** 

Parameter	Conditions	MIN	TYP	MAX	Units
BOR voltage threshold variation	-40°C to +85°C	1.72	1.83	1.92	V

## AC & DC Electrical Characteristic Graphs

The graphs in this section are for design guidance and are based on preliminary test data.

**Figure 6. Internal Oscillator Frequency**

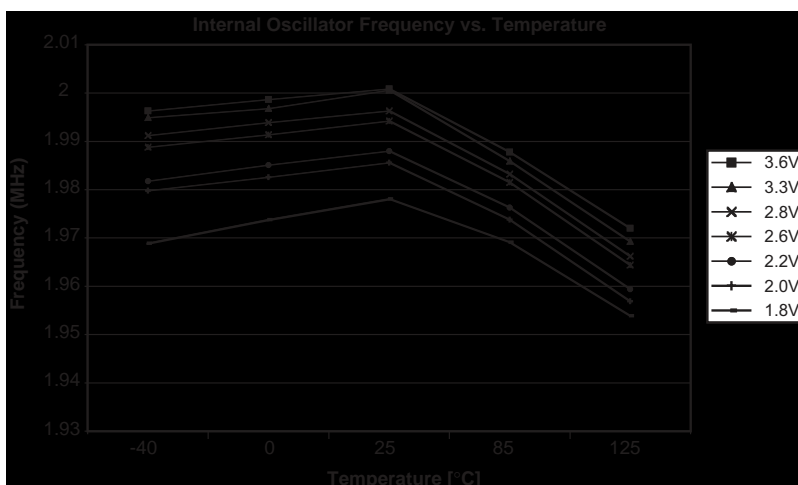

**Figure 7. LBD and BOR Threshold Levels**

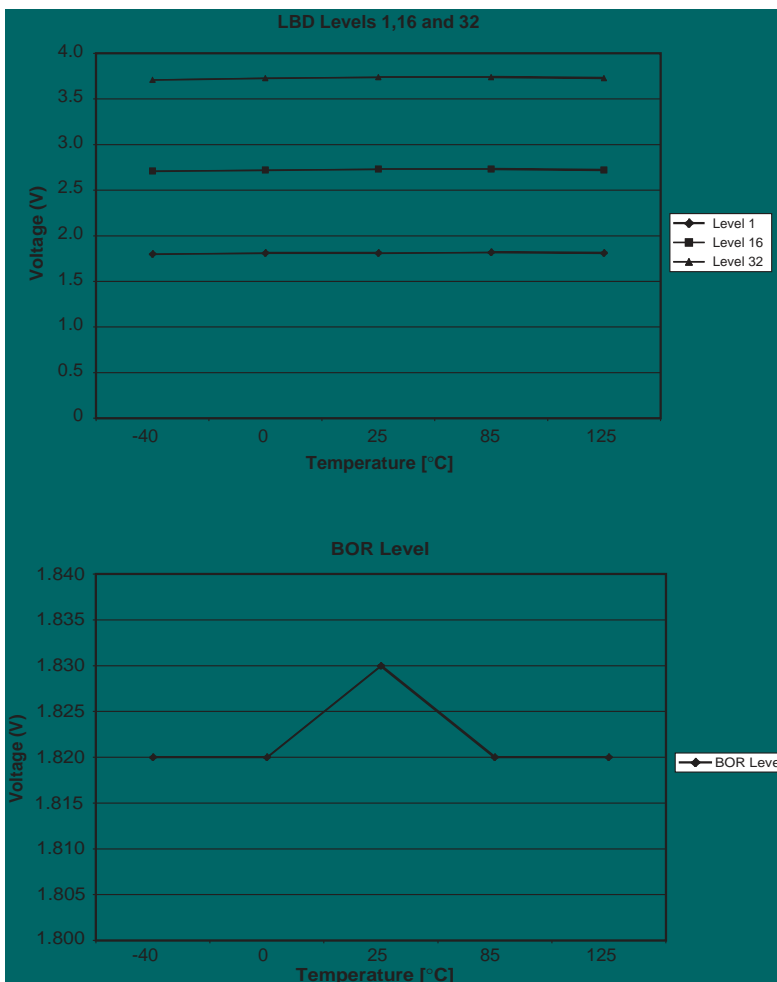

Figure 8. Icc Active

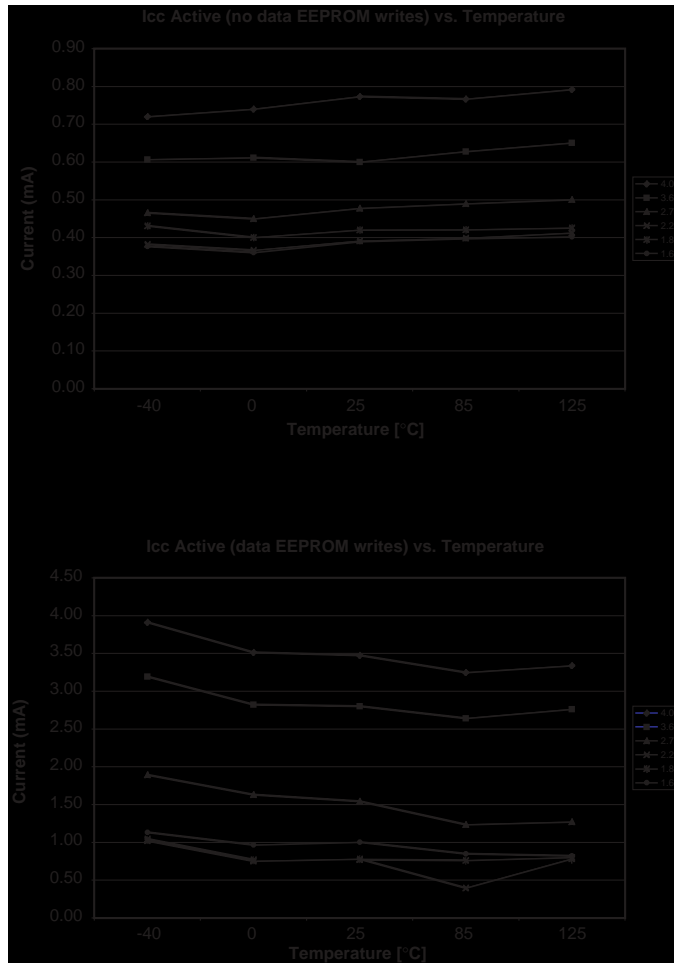

Figure 9. HALT Mode Currents

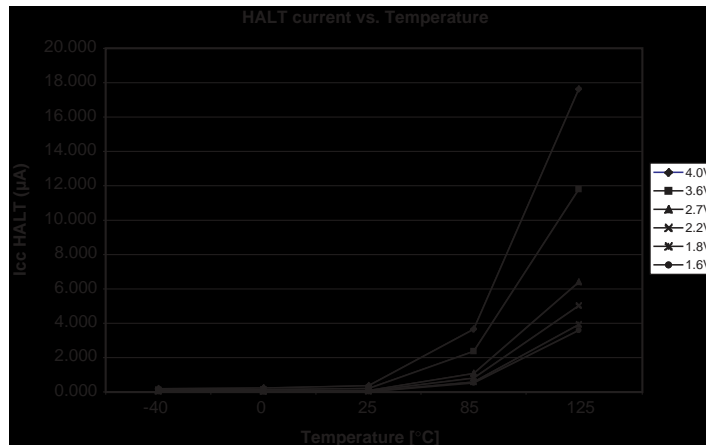

Figure 10. IDLE Mode Currents

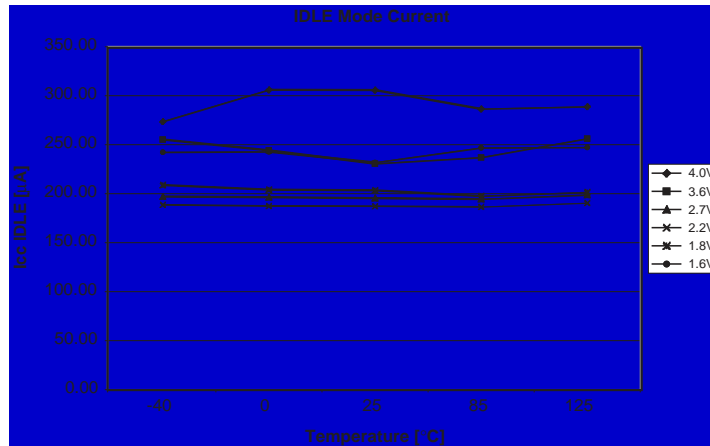
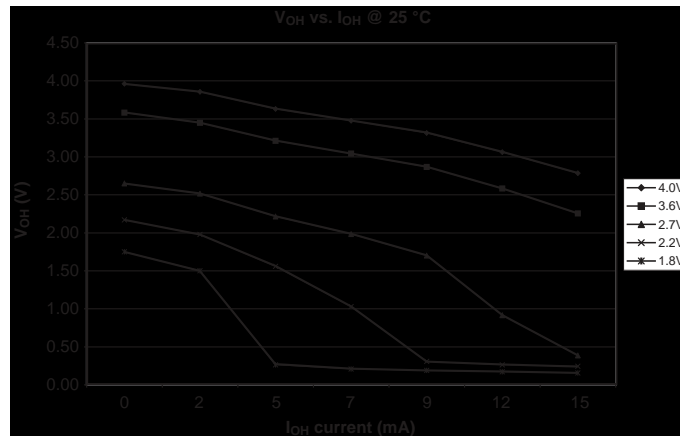
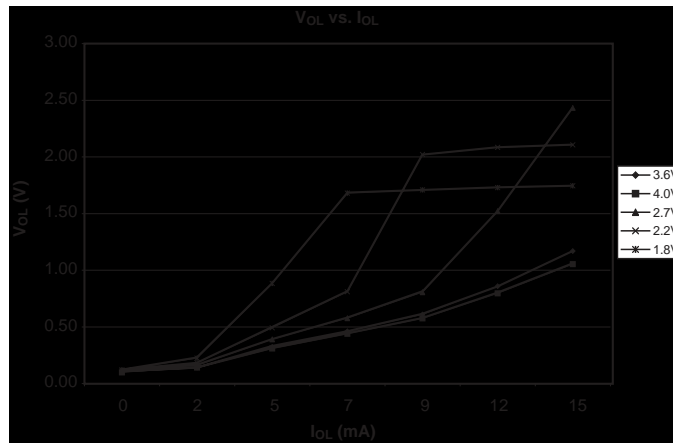

Figure 11.  $V_{OL}/V_{OH}$  vs. Current



### 3. Arithmetic Controller Core

The ACEx microcontroller core is specifically designed for low cost applications involving bit manipulation, shifting and block encryption. It is based on a modified Harvard architecture meaning peripheral, I/O, and RAM locations are addressed separately from instruction data.

The core differs from the traditional Harvard architecture by aligning the data and instruction memory sequentially. This allows the X-pointer (12-bits) to point to any memory location in either segment of the memory map. This modification improves

the overall code efficiency of the ACEx microcontroller and takes advantage of the flexibility found on Von Neumann style machines.

#### 3.1 CPU Registers

The ACEx microcontroller has five general-purpose registers. These registers are the Accumulator (A), X-Pointer (X), Program Counter (PC), Stack Pointer (SP), and Status Register (SR). The X, SP, and SR registers are all memory-mapped.

**Figure 12. Programming Model**

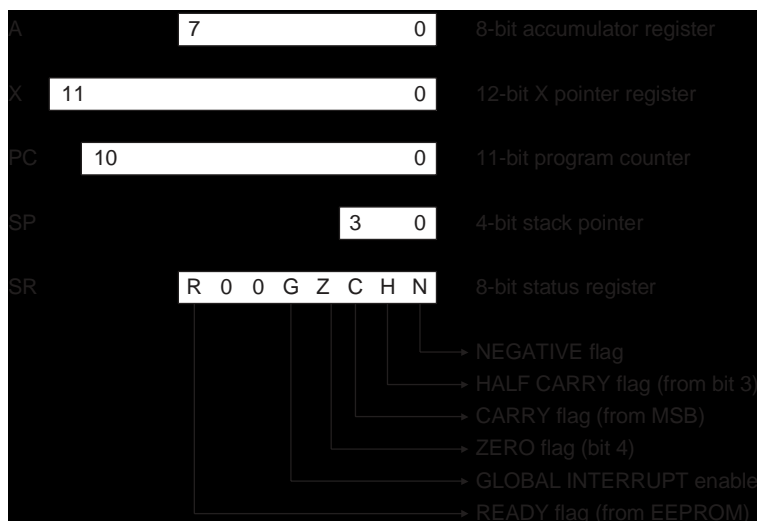

#### 3.1.1 Accumulator (A)

The Accumulator is a general-purpose 8-bit register that is used to hold data and results of arithmetic calculations or data manipulations.

#### 3.1.2 X-Pointer (X)

The X-Pointer register allows for a 12-bit indexing value to be added to an 8-bit offset creating an effective address used for reading and writing between the entire memory space. (Software can only read from code EEPROM.) This provides software with the flexibility of storing lookup tables in the code EEPROM memory space for the core's accessibility during normal operation.

The ACEx core allows software to access the entire 12-bit X-Pointer register using the special X-pointer instructions e.g. LD X, #000H. (See Table 8.) However, software may also access the register through any of the memory-mapped instructions using the XHI (X[11:8]) and XLO (X[7:0]) variables located at 0xBE and 0xBF, respectively. (See Table 10.)

The X register is divided into two sections. The 11 least significant bits (LSBs) of the register is the address of the program or data memory space. The most significant bit (MSB) of the register is write only and selects between the data (0x000 to 0x0FF) or program (0x800 to 0xFFFF) memory space.

Example: If Bit 11 = 0, then the LD A, [00,X] instruction will take a value from address range 0x000 to 0x0FF and load it into A. If

Bit 11 = 1, then the LD A, [00,X] instruction will take a value from address range 0x800 to 0xFFFF and load it into A.

The X register can also serve as a counter or temporary storage register. However, this is true only for the 11-LSBs since the 12<sup>th</sup> bit is dedicated for memory space selection.

#### 3.1.3 Program Counter (PC)

The 11-bit program counter register contains the address of the next instruction to be executed. After a reset, if in normal mode the program counter is initialized to 0x800.

#### 3.1.4 Stack Pointer (SP)

The ACEx microcontroller has an automatic program stack with a 4-bit stack pointer. The stack can be initialized to any location between addresses 0x30-0x3F. Normally, the stack pointer is initialized by one of the first instructions in an application program. After a reset, the stack pointer is defaulted to 0xF pointing to address 0x3F.

The stack is configured as a data structure which decrements from high to low memory. Each time a new address is pushed onto the stack, the core decrements the stack pointer by two. Each time an address is pulled from the stack, the core increments the stack pointer by two. At any given time, the stack pointer points to the next free location in the stack.

When a subroutine is called by a jump to subroutine (JSR) instruction, the address of the instruction is automatically pushed onto the stack least significant byte first. When the



subroutine is finished, a return from subroutine (RET) instruction is executed. The RET instruction pulls the previously stacked return address from the stack and loads it into the program counter. Execution then continues at the recovered return address.

### 3.1.5 Status Register (SR)

The 8-bit Status register (SR) contains four condition code indicators (C, H, Z, and N), one interrupt masking bit (G), and an EEPROM write flag (R.) The condition codes are automatically updated by most instructions. (See Table 9.)

#### Carry/Borrow (C)

The carry flag is set if the arithmetic logic unit (ALU) performs a carry or borrow during an arithmetic operation and by its dedicated instructions. The rotate instruction operates with and through the carry bit to facilitate multiple-word shift operations. The LDC and INVC instructions facilitate direct bit manipulation using the carry flag.

#### Half Carry (H)

The half carry flag indicates whether an overflow has taken place on the boundary between the two nibbles in the accumulator. It is primarily used for Binary Coded Decimal (BCD) arithmetic calculation.

#### Zero (Z)

The zero flag is set if the result of an arithmetic, logic, or data manipulation operation is zero. Otherwise, it is cleared.

#### Negative (N)

The negative flag is set if the MSB of the result from an arithmetic, logic, or data manipulation operation is set to one. Otherwise, the flag is cleared. A result is said to be negative if its MSB is a one.

#### Interrupt Mask (G)

The interrupt request mask (G) is a global mask that disables all maskable interrupt sources. If the G Bit is cleared, interrupts can become pending, but the operation of the core continues uninterrupted. However, if the G Bit is set an interrupt is recognized. After any reset, the G bit is cleared by default and can only be set by a software instruction. When an interrupt is recognized, the G bit is cleared after the PC is stacked and the interrupt vector is fetched. Once the interrupt is serviced, a

return from interrupt instruction is normally executed to restore the PC to the value that was present before the interrupt occurred. The G bit is the reset to one after a return from interrupt is executed. Although the G bit can be set within an interrupt service routine, “nesting” interrupts in this way should only be done when there is a clear understanding of latency and of the arbitration mechanism.

### 3.2 Interrupt handling

When an interrupt is recognized, the current instruction completes its execution. The return address (the current value in the program counter) is pushed onto the stack and execution continues at the address specified by the unique interrupt vector (see Table 10.). This process takes five instruction cycles. At the end of the interrupt service routine, a return from interrupt (RETI) instruction is executed. The RETI instruction causes the saved address to be pulled off the stack in reverse order. The G bit is set and instruction execution resumes at the return address.

The ACEx microcontroller is capable of supporting four interrupts. Three are maskable through the G bit of the SR and the fourth (software interrupt) is not inhibited by the G bit (Figure 13.) The software interrupt is generated by the execution of the INTR instruction. Once the INTR instruction is executed, the ACEx core will interrupt whether the G bit is set or not. The INTR interrupt is executed in the same manner as the other maskable interrupts where the program counter register is stacked and the G bit is cleared. This means, if the G bit was enabled prior to the software interrupt the RETI instruction must be used to return from interrupt in order to restore the G bit to its previous state. However, if the G bit was not enabled prior to the software interrupt the RET instruction must be used.

In case of multiple interrupts occurring at the same time, the ACEx microcontroller core has prioritized the interrupts. The interrupt priority sequence is shown in Table 7.

Table 7: Interrupt Priority Sequence

Priority (4 highest, 1 lowest)	Interrupt
4	MIW (EDGEI)
3	Timer0 (TMR10)
2	Timer1 (TMR11)
1	Software (INTR)

Figure 13. Basic Interrupt Structure

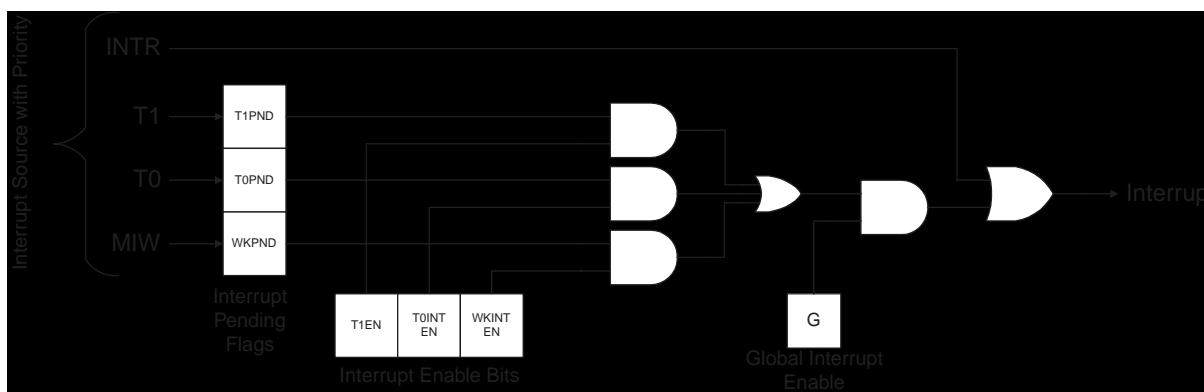

### 3.3 Addressing Modes

The ACEx microcontroller has seven addressing modes indexed, indirect, direct, immediate, absolute jump, and relative jump.

#### Indexed

The instruction allows an 8-bit unsigned offset value to be added to the 11-LSBs of the X-pointer yielding a new effective address. This mode can be used to address either data or program memory space.

#### Indirect

The instruction allows the X-pointer to address any location within the data memory space.

#### Direct

The instruction contains an 8-bit address field that directly points to the data memory space as an operand.

#### Immediate

The instruction contains an 8-bit immediate field as an operand.

#### Inherent

This instruction has no operands associated with it.

#### Absolute

The instruction contains an 11-bit address that directly points to a location in the program memory space. There are two operands associated with this addressing mode. Each operand contains a byte of an address. This mode is used only for the long jump (JMP) and JSR instructions.

#### Relative

This mode is used for the short jump (JP) instructions where the operand is a value relative to the current PC address. With this instruction, software is limited to the number of bytes it can jump, -31 or +32.

**Table 8. Instruction Addressing Modes**

Instruction	Immediate			Direct	Indexed	Indirect	Inherent	Relative	Absolute
ADC	A, #			A, M	A, [#, X]	A, [X]			
ADD	A, #			A, M	A, [#, X]	A, [X]			
AND	A, #			A, M	A, [#, X]	A, [X]			
OR	A, #			A, M	A, [#, X]	A, [X]			
SUBC	A, #			A, M	A, [#, X]	A, [X]			
XOR	A, #			A, M	A, [#, X]	A, [X]			
CLR				M			A	X	
INC				M			A	X	
DEC				M			A	X	
IFEQ	A, #	X, #	M, #	A, M	A, [#, X]	A, [X]			
IFGT	A, #	X, #		A, M	A, [#, X]	A, [X]			
IFNE	A, #	X, #	M, #	A, M	A, [#, X]	A, [X]			
IFLT		X, #							
SC							no-op		
RC							no-op		
IFC							no-op		
IFNC							no-op		
INVC							no-op		
LDC				#, M					
STC				#, M					
RLC				M			A		
RRC				M			A		
LD	A, #	M, #	X, #	A, M	M, M	A, [#, X]	A, [X]		
ST				A, M		A, [#, X]	A, [X]		
NOP							no-op		
IFBIT	#, A			#, M		[#, X]			
IFNBIT	#, A			#, M		[#, X]			
SBIT				#, M		[#, X]			
RBIT				#, M		[#, X]			
JP					[#, X]			Rel	M
JSR					[#, X]				M
JMP					[#, X]				
RET							no-op		
RETI							no-op		
INTR							no-op		

Table 9. Instruction Cycles and Bytes

Mnemonic	Operand	Bytes	Cycles	Flags affected
ADC	A, [X]	1	1	C,H,Z,N
ADC	A, [# ,X]	2	3	C,H,Z,N
ADC	A, M	2	2	C,H,Z,N
ADC	A, #	2	2	C,H,Z,N
ADD	A, [X]	1	1	Z,N
ADD	A, [# ,X]	2	3	Z,N
ADD	A, M	2	2	Z,N
ADD	A, #	2	2	Z,N
AND	A, [X]	1	1	Z,N
AND	A, [# ,X]	2	3	Z,N
AND	A, M	2	2	Z,N
AND	A, #	2	2	Z,N
CLR	X	1	1	Z
CLR	A	1	1	C,H,Z,N
CLR	M	2	1	C,H,Z,N
DEC	X	1	1	Z
DEC	A	1	1	Z,N
DEC	M	2	2	Z,N
IFBIT	#, A	1	1	None
IFBIT	#, M	2	2	None
IFBIT	#, [X]	1	1	None
IFC		1	1	None
IFEQ	A, [# , X]	2	3	None
IFEQ	A, [X]	1	1	None
IFEQ	A, #	2	2	None
IFEQ	A, M	2	2	None
IFEQ	M, #	3	3	None
IFEQ	X, #	3	3	None
IFGT	A, [# , X]	2	3	None
IFGT	A, [X]	1	1	None
IFGT	A, #	2	2	None
IFGT	A, M	2	2	None
IFGT	X, #	3	3	None
IFLT	X, #	3	3	None
IFNBIT	#, A	1	1	None
IFNBIT	#, M	2	2	None
IFNBIT	#, [X]	1	1	None
IFNC		1	1	None
IFNE	A, [# , X]	2	3	None
IFNE	A, [X]	1	1	None
IFNE	A, #	2	2	None
IFNE	A, M	2	2	None
IFNE	X, #	3	3	None
IFNE	M, #	3	3	None
INC	A	1	1	Z,N
INC	M	2	2	Z,N

Mnemonic	Operand	Bytes	Cycles	Flags affected
INC	X	1	1	Z
INTR		1	5	None
INVC		1	1	C
JMP	M	3	4	None
JMP	[# , X]	2	3	None
JP		1	1	None
JSR	M	3	5	None
JSR	[# , X]	2	5	None
LD	A, #	2	2	None
LD	A, [# ,X]	2	3	None
LD	A, [X]	1	1	None
LD	A, M	2	2	None
LD	M, #	3	3	None
LD	M, M	3	3	None
LD	X, #	3	3	None
LDC	#, M	2	2	C
NOP		1	1	None
OR	A, [X]	1	1	Z, N
OR	A, [# ,X]	2	3	Z,N
OR	A, M	2	2	Z,N
OR	A, #	2	2	Z,N
RBIT	#, [X]	1	2	Z,N
RBIT	#, M	2	2	Z,N
RC		1	1	C,H
RET		1	5	None
RETI		1	5	None
RLC	A	1	1	C,Z,N
RLC	M	2	2	C,Z,N
RRC	A	1	1	C,Z,N
RRC	M	2	2	C,Z,N
SBIT	#, [X]	1	2	Z,N
SBIT	#, M	2	2	Z,N
SC		1	1	C,H
ST	A, [# ,X]	2	3	None
ST	A, [X]	1	1	None
ST	A, M	2	2	None
STC	#, M	2	2	Z,N
SUBC	A, [X]	1	1	C,H,Z,N
SUBC	A, [# ,X]	2	3	C,H,Z,N
SUBC	A, M	2	2	C,H,Z,N
SUBC	A, #	2	2	C,H,Z,N
XOR	A, [X]	1	1	Z,N
XOR	A, [# ,X]	2	3	Z,N
XOR	A, M	2	2	Z,N
XOR	A, #	2	2	Z,N

### 3.4 Memory Map

All I/O ports, peripheral registers, and core registers (except the accumulator and the program counter) are mapped into the memory space.

**Table 10. Memory Mapped Registers**

Address	Memory Space	Block	Contents
0x00 - 0x3F	Data	SRAM	Data RAM
0x40 - 0x7F	Data	EEPROM	Data EEPROM
0x80-0x9F	Data	Reserved	
0xA0	Data	HBC	HBCNTRL register
0xA1	Data	HBC	PSCALE register
0xA2	Data	HBC	HPATTERN register
0xA3	Data	HBC	LPATTERN register
0xA4	Data	HBC	BPSEL register
0xA7	Data	Timer1	T1RBLO register
0xA8	Data	Timer1	T1RBHI register
0xA9	Data	HBC	DAT0 register
0xAA	Data	Timer1	T1RALO register
0xAB	Data	Timer1	T1RAHI register
0xAC	Data	Timer1	TMR1LO register
0xAD	Data	Timer1	TMR1HI register
0xAE	Data	Timer1	T1CNTRL register
0xAF	Data	MIW	WKEDG register
0xB0	Data	MIW	WKPND register
0xB1	Data	MIW	WKEN register
0xB2	Data	I/O	PORTGD register
0xB3	Data	I/O	PORTGC register
0xB4	Data	I/O	PORTGP register
0xB5	Data	Timer0	WDSVR register
0xB6	Data	Timer0	T0CNTRL register
0xB7	Data	Clock	HALT mode register
0xB8-0xBA	Data	Reserved	
0xBB	Data	Init. Register	Initialization Register 1
0xBC	Data	Init. Register	Initialization Register 2
0xBD	Data	LBD	LBD register
0xBE	Data	Core	XHI register
0xBF	Data	Core	XLO register
0xC0	Data	Clock	Power Mode Clear (PMC) Register
0xCE	Data	Core	SP register
0xCF	Data	Core	Status register (SR)
0xD0 - 0xFF	Data	Reserved	
0x800 - 0xBF5	Program	EEPROM	Code EEPROM
0xFF6 - 0xFF7	Program	Core	Timer0 Interrupt vector
0xFF8 - 0xFF9	Program	Core	Timer1 Interrupt vector
0xFFA - 0xFFB	Program	Core	MIW Interrupt vector
0xFFC - 0xFFD	Program	Core	Soft Interrupt vector
0xFFE - 0xFFFF	Program	Reserved	

### 3.5 Memory

The ACE<sup>x</sup> microcontroller has 64 bytes of SRAM and 64 bytes of EEPROM available for data storage. The device also has 1K bytes of EEPROM for program storage. Software can read and write to SRAM and data EEPROM but can only read from the code EEPROM. While in normal mode, the code EEPROM is protected from any writes. The code EEPROM can only be rewritten when the device is in program mode and if the write disable (WDIS) bit of the initialization register is not set to 1.

While in normal mode, the user can write to the data EEPROM array by 1) polling the ready (R) flag of the SR, then 2) executing the appropriate instruction. If the R flag is 1, the data EEPROM block is ready to perform the next write. If the R flag is 0, the data EEPROM is busy. The data EEPROM array will reset the R flag after the completion of a write cycle. Attempts to

read, write, or enter HALT/IDLE mode while the data EEPROM is busy (R = 0) can affect the current data being written.

### 3.6 Initialization Registers

The ACE<sup>x</sup> microcontroller has two 8-bit wide initialization registers. These registers are read from the memory space on power-up to initialize certain on-chip peripherals. Figure 14 provides a detailed description of Initialization Register 1. The Initialization Register 2 is used to trim the internal oscillator to its appropriate frequency. This register is pre-programmed in the factory to yield an internal instruction clock of 1MHz.

The Initialization Registers 1 and 2 can be read from and written to during programming mode. However, re-trimming the internal oscillator (writing to the Initialization Register 2) once it has left the factory is *discouraged*.

**Figure 14. Initialization Register 1**

Bit 7	Bit 6	Bit 5	Bit 4	Bit 3	Bit 2	Bit 1	Bit 0
CMODE[0]	CMODE[1]	WDEN	BOREN	LDBEN	UBD	WDIS	RDIS

- |              |  |
|--------------|--|
| (0) RDIS     | If set, disables attempts to read the contents from the memory while in programming mode. Once this bit is set, it is no longer possible to unset this option even though the write disable option is not enabled. |
| (1) WDIS     | If set, disables attempts to write new contents to the memory while in programming mode  |
| (2) UBD      | If set, the device will not allow any writes to occur in the upper block of data EEPROM (0x60-0x7F)  |
| (3) LDBEN    | If set, the Low Battery Detection circuit is enabled   |
| (4) BOREN    | If set, allows a BOR to occur if V <sub>cc</sub> falls below the voltage reference level   |
| (5) WDEN     | If set, enables the on-chip processor watchdog circuit   |
| (6) CMODE[1] | Clock mode select bit 1 (See Table 16)   |
| (7) CMODE[0] | Clock mode select bit 0 (See Table 16)   |

## 4. Timer 1

Timer 1 is a versatile 16-bit timer that can operate in one of four modes:

- **Pulse Width Modulation (PWM)** mode, which generates pulses of a specified width and duty cycle
- **External Event Counter** mode, which counts occurrences of an external event
- **Standard Input Capture** mode, which measures the elapsed time between occurrences of external events
- **Difference Input Capture** mode, which automatically measures the difference between edges.

Timer 1 contains a 16-bit timer/counter register (TMR1), a 16-bit auto-reload/capture register (T1RA), a secondary 16-bit auto-reload register (T1RB), and an 8-bit control register (T1CNTRL). All register are memory-mapped for simple access through the core with both the 16-bit registers organized as a pair of 8-bit register bytes {TMR1HI, TMR1LO}, {T1RAHI, T1RALO}, and {T1RBHI, T1RBLO}. Depending on the operating mode, the timer contains an external input or output (T1) that is multiplexed with the I/O pin G2. By default, the TMR1 is reset to 0xFFFF, T1RA/T1RB is reset to 0x0000, and T1CNTRL is reset to 0x00.

The timer can be started or stopped through the T1CNTRL register bit T1C0. When running, the timer counts down (decrements) every clock cycle. Depending on the operating mode, the timer's clock is either the instruction clock or a transition on the T1 input. In addition, occurrences of timer underflow (transitions from 0x0000 to 0xFFFF/T1RA/T1RB value) can either generate an interrupt and/or toggle the T1 output pin.

Timer 1's interrupt (TMR1I) can be enabled by interrupt enable (T1EN) bit in the T1CNTRL register. When the timer interrupt is enabled, depending on the operating mode, the source of the interrupt is a timer underflow and/or a timer capture.

### 4.1 Timer control bits

Reading and writing to the T1CNTRL register controls the timer's operation. By writing to the control bits, the user can enable or disable the timer interrupts, set the mode of operation, and start or stop the timer. The T1CNTRL register bits are described in Table 11 and Table 12.

**Table 11. Timer 1 Control Register (T1CNTRL)**

T1CNTRL Register	Bit Name	Function
Bit 7	T1C3	Timer TIMER1 control bit 3 (see Table 12)
Bit 6	T1C2	Timer TIMER1 control bit 2 (see Table 12)
Bit 5	T1C1	Timer TIMER1 control bit 1 (see Table 12)
Bit 4	T1C0	Timer TIMER1 run: 1= Start timer, 0 = Stop timer; or Timer TIMER1 underflow interrupt pending flag in input capture mode
Bit 3	T1PND	Timer1 interrupt pending flag: 1 = Timer1 interrupt Pending, 0 = Timer1 interrupt not pending
Bit 2	T1EN	Timer1 interrupt enable bit: 1 = Timer1 interrupt enabled, 0 = Timer1 interrupt disabled
Bit 1	M1S1	Capture type: 0 = Pulse capture, 1 = Cycle capture (see Table 12)
Bit 0	T1RBEN	PWM Mode: 0 = Timer1 reload on T1RA, 1 = TIMER1 reload on T1RA and T1RB (always starting with T1RA)

**Table 12. Timer 1 Operating Modes**

T1 C3	T1 C2	T1 C1	M4 S1	T1 RB	Timer Mode Source	Interrupt	Timer Counts-on
0	0	0	X	X	MODE 2	TIMER1 Underflow	T1 Pos. Edge
0	0	1	X	X	MODE 2	TIMER1 Underflow	T1 Neg. Edge
1	0	1	X	0	MODE 1 T1 Toggle	Autoreload T1RA	Instruction Clock
1	0	0	X	0	MODE 1 No T1 Toggle	Autoreload T1RA	Instruction Clock
1	0	1	X	1	MODE 1 T1 Toggle	Autoreload T1RA/T1RB	Instruction Clock
1	0	0	X	1	MODE 1 No T1 Toggle	Autoreload T1RA/T1RB	Instruction Clock
0	1	0	X	X	MODE 3 Captures: T1 Pos Edge	Pos. T1 Edge	Instruction Clock
0	1	1	X	X	MODE 3 Captures: T1 Neg Edge	Neg. T1 Edge	Instruction Clock
1	1	0	0	X	MODE 4	Pos. to Neg.	Instruction Clock
1	1	0	1	X	MODE 4	Pos. to Pos.	Instruction Clock
1	1	1	0	X	MODE 4	Neg. to Pos.	Instruction Clock
1	1	1	1	X	MODE 4	Neg. to Neg.	Instruction Clock

#### 4.2 Mode 1: Pulse Width Modulation (PWM) Mode

In the PWM mode, the timer counts down at the instruction clock rate. When an underflow occurs, the timer register is reloaded from T1RA/T1RB and the count down proceeds from the loaded value. At every underflow, a pending flag (T1PND) located in the T1CNTRL register is set. Software must then clear the T1PND flag and load the T1RA/T1RB register with an alternate PWM value (if desired.) In addition, the timer can be configured to toggle the T1 output bit upon underflow. Configuring the timer to toggle T1 results in the generation of a signal outputted from port G2 with the width and duty cycle controlled by the values stored in the T1RA/T1RB. A block diagram of the timer's PWM mode of operation is shown in Figure 15.

The PWM timer can be configured to use the T1RA register only for auto-reloading the timer registers or can be configured to use both T1RA and T1RB alternately. If the T1RBEN bit of the T1CNTRL register is 0, the PWM timer will reload using only T1RA ignoring any value store in the T1RB register. However, if the T1RBEN bit is 1 the PWM timer will be reloaded using both

the T1RA and T1RB registers. A hardware select logic is implemented to select between T1RA and T1RB alternately, always starting with T1RA, every timer underflows to auto-reload the timer registers. This feature is useful when a signal with variable duty cycle needs to be generated without software intervention.

The timer has one interrupt (TMR11) that is maskable through the T1EN bit of the T1CNTRL register. However, the core is only interrupted if the T1EN bit and the G (Global Interrupt enable) bit of the SR is set. If interrupts are enabled, the timer will generate an interrupt each time T1PND flags is set (whenever the timer underflows provided that the pending flag was cleared.) The interrupt service routine is responsible for proper handling of the T1PND flag and the T1EN bit.

The interrupt will be synchronous with every rising and falling edge of the T1 output signal. Generating interrupts only on rising or falling edges of T1 is achievable through appropriate handling of the T1EN bit or T1PND flag through software.

The following steps show how to properly configure Timer 1 to operate in the PWM mode. For this example, the T1 output signal is toggled with every timer underflow and the “high” and “low” times for the T1 output can be set to different values. The T1 output signal can start out either high or low depending on the configuration of G2; the instructions below are for starting with the T1 output high. Follow the instructions in parentheses to start the T1 output low.

- Configure T1 as an output by setting bit 2 of PORTGC.
  - SBIT 2, PORTGC ; Configure G2 as an output
- Initialize T1 to 1 (or 0) by setting (or clearing) bit 2 of PORTGD.
  - SBIT 2, PORTGD ; Set G2 high
- Load the initial PWM high (low) time into the timer register.
  - LD TMR1LO, #6FH ; High (Low) for 1.391ms (1MHz clock)
  - LD TMR1HI, #05H
- Load the PWM low (high) time into the T1RA register.
  - LD T1RALO, #2FH ; Low (High) for .303ms (1MHz clock)
  - LD T1RAHI, #01H
- Write the appropriate control value to the T1CNTRL register to select PWM mode with T1 toggle, to clear the enable bit and pending flag, and to start the timer. (See Table 11 and Table 12.)
  - LD T1CNTRL, #0B0H ; Setting the T1C0 bit starts the timer
- After every underflow, load T1RA with alternate values. If the user wishes to generate an interrupt on a T1 output transition, reset the pending flags and then enable the interrupt using T1EN. The G bit must also be set. The interrupt service routine must reset the pending flag and perform whatever processing is desired.
  - RBIT T1PND, T1CNTRL ; T1PND equals 3
  - LD T1RALO, #6FH ; High (Low) for 1.391ms (1MHz clock)
  - LD T1RAHI, #05H

Figure 15. Pulse Width Modulation Mode

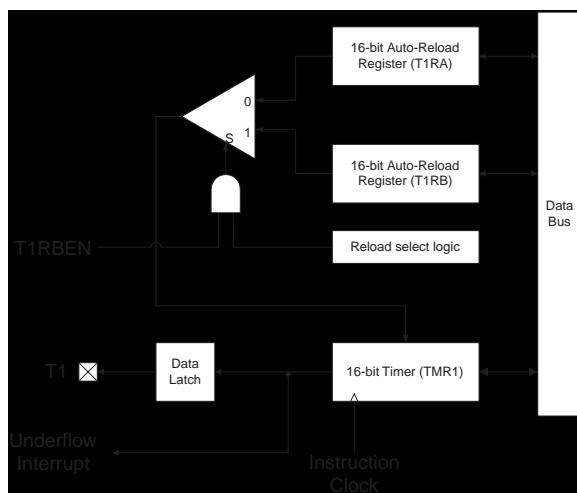

### 4.3 Mode 2: External Event Counter Mode

The External Event Counter mode operates similarly to the PWM mode; however, the timer is not clocked by the instruction clock but by transitions of the T1 input signal. The edge is selectable through the T1C1 bit of the T1CNTRL register. A block diagram of the timer’s External Event Counter mode of operation is shown in Figure 16.

The T1 input should be connected to an external device that generates a positive/negative-going pulse for each event. By clocking the timer through T1, the number of positive/negative transitions can be counted therefore allowing software to capture the number of events that occur. The input signal on T1 must have a pulse width equal to or greater than one instruction clock cycle.

The counter can be configured to sense either positive-going or negative-going transitions on the T1 pin. The maximum frequency at which transitions can be sensed is one-half the frequency of the instruction clock.

As with the PWM mode, when the counter underflows the counter is reloaded from the T1RA register and the count down proceeds from the loaded value. At every underflow, a pending flag (T1PND) located in the T1CNTRL register is set. Software must then clear the T1PND flag and can then load the T1RA register with an alternate value.

The counter has one interrupt (TMRI1) that is maskable through the T1EN bit of the T1CNTRL register. However, the core is only interrupted if the T1EN bit and the G (Global Interrupt enable) bit of the SR is set. If interrupts are enabled, the counter will generate an interrupt each time the T1PND flag is set (when timer underflows provided that the pending flag was cleared.) The interrupt service routine is responsible for proper handling of the T1PND flag and the T1EN bit.

The following steps show how to properly configure Timer 1 to operate in the External Event Counter mode. For this example, the counter is clocked every falling edge of the T1 input signal. Follow the instructions in parentheses to clock the counter every rising edge.

- Configure T1 as an input by clearing bit 2 of PORTGC.
  - RBIT 2, PORTGC ; Configure G2 as an input
- Initialize T1 to input with pull-up by setting bit 2 of PORTGD.
  - SBIT 2, PORTGD ; Set G2 high
- Enable the global interrupt enable bit.
  - SBIT 4, STATUS
- Load the initial count into the TMR1 and T1RA registers. When the number of external events is detected, the counter will reach zero; however, it will not underflow until the next event is detected. To count N pulses, load the value N-1 into the registers. If it is only necessary to count the number of occurrences and no action needs to be taken at a particular count, load the value 0xFFFF into the registers.
  - LD TMR1LO, #0FFH
  - LD TMR1HI, #0FFH
  - LD T1RALO, #0FFH
  - LD T1RAHI, #0FFH

5. Write the appropriate control value to the T1CNTRL register to select External Event Counter mode, to clock every falling edge, to set the enable bit, to clear the pending flag, and to start the counter. (See Table 11 and Table 12)
  - LD T1CNTRL, #34H (#00h) ;Setting the T1C0 bit starts the timer
6. When the counter underflows, the interrupt service routine must clear the T1PND flag and take whatever action is required once the number of events occurs. If the software wishes to merely count the number of events and the anticipated number may exceed 65,536, the interrupt service routine should record the number of underflows by incrementing a counter in memory. Software can then calculate the correct event count.
  - RBIT T1PND, T1CNTRL ; T1PND equals 3

**Figure 16. External Event Counter Mode**

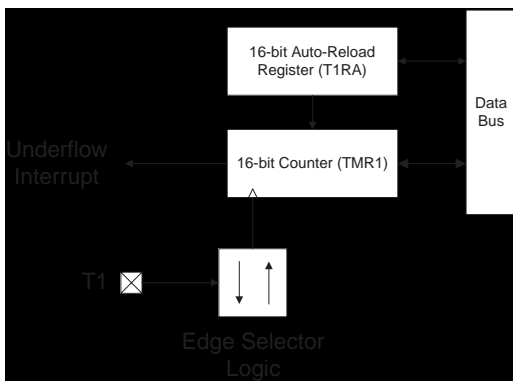

#### 4.4 Mode 3: Input Capture Mode

In the Input Capture mode, the timer is used to measure elapsed time between edges of an input signal. Once the timer is configured for this mode, the timer starts counting down immediately at the instruction clock rate. The Timer 1 will then transfer the current value of the TMR1 register into the T1RA register as soon as the selected edge of T1 is sensed. The input signal on T1 must have a pulse width equal to or greater than one instruction clock cycle. At every T1RA capture, software can then store the values into RAM to calculate the elapsed time between edges on T1. At any given time (with proper consideration of the state of T1) the timer can be configured to capture on positive-going or negative-going edges. A block diagram of the timer's Input Capture mode of operation is shown in Figure 17.

The timer has one interrupt (TMR1I) that is maskable through the T1EN bit of the T1CNTRL register. However, the core is only interrupted if the T1EN bit and the G (Global Interrupt enable) bit of the SR is set. The Input Capture mode contains two interrupt pending flags 1) the TMR1 register capture in T1RA (T1PND) and 2) timer underflow (T1C0). If interrupts are enabled, the timer will generate an interrupt each time a pending flag is set (provided that the pending flag was previously cleared.) The interrupt service routine is responsible for proper handling of the T1PND flag, T1C0 flag, and the T1EN bit.

For this operating mode, the T1C0 control bit serves as the timer underflow interrupt pending flag. The Timer 1 interrupt service routine must read both the T1PND and T1C0 flags to determine the cause of the interrupt. A set T1C0 flag means that a timer underflow occurred whereas a set T1PND flag means that a capture occurred in T1RA. It is possible that both flags will be found set, meaning that both events occurred at the same time. The interrupt service routine should take this possibility into consideration.

Because the T1C0 bit is used as the underflow interrupt pending flag, it is not available for use as a start/stop bit as in the other modes.

The TMR1 register counts down continuously at the instruction clock rate starting from the time that the input capture mode is selected. (See Table 11 and Table 12) To stop the timer from running, you must change the mode to an alternate mode (PWM or External Event Counter) while resetting the T1C0 bit.

The input pins can be independently configured to sense positive-going or negative-going transitions. The edge sensitivity of pin T1 is controlled by bit T1C1 as indicated in Table 12.

The edge sensitivity of a pin can be changed without leaving the input capture mode even while the timer is running. This feature allows you to measure the width of a pulse received on an input pin.

For example, the T1 pin can be programmed to be sensitive to a positive-going edge. When the positive edge is sensed, the TMR1 register contents is transferred to the T1RA register and a Timer 1 interrupt is generated. The Timer 1 interrupt service routine records the contents of the T1RA register, changes the edge sensitivity from positive to negative-going edge, and clears the T1PND flag. When the negative-going edge is sensed another Timer 1 interrupt is generated. The interrupt service routine reads the T1RA register again. The difference between the previous reading and the current reading reflects the elapsed time between the positive edge and negative edge of the T1 input signal i.e. the width of the positive-going pulse.

Remember that the Timer1 interrupt service routine must test the T1C0 and T1PND flags to determine the cause of the interrupt. If the T1C0 flag caused the interrupt, the interrupt service routine should record the occurrence of an underflow by incrementing a counter in memory or by some other means. The software that calculates the elapsed time between captures should take into account the number of underflow that occurred when making its calculation.

The following steps show how to properly configure Timer 1 to operate in the Input Capture mode.

1. Configure T1 as an input by clearing bit 2 of PORTGC.
  - RBIT 2, PORTGC ; Configure G2 as an input
2. Initialize T1 to input with pull-up by setting bit 2 of PORTGD.
  - SBIT 2, PORTGD ; Set G2 high
3. Enable the global interrupt enable bit.
  - SBIT 4, STATUS
4. With the timer stopped, load the initial time into the TMR1 register (typically the value is 0xFFFF.)
  - LD TMR1LO, #0FFH
  - LD TMR1HI, #0FFH
5. Write the appropriate control value to the T1CNTRL register to select Input Capture mode, to sense the appropriate edge, to set the enable bit, and to clear the pending flags.



(See Table 11 and Table 12)  
 - LD T1CNTRL, #64H ; T1C1 is the edge select bit

- As soon as the input capture mode is enabled, the timer starts counting. When the selected edge is sensed on T1, the T1RA register is loaded and a Timer 1 interrupt is triggered.

**Figure 17. Input Capture Mode**

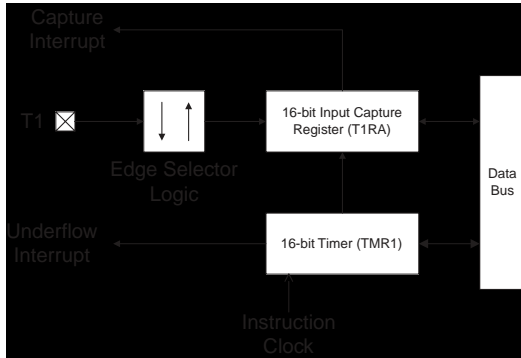

#### 4.5 Mode 4: Difference Input Capture Mode

The Difference Input Capture mode works similarly to the standard Input Capture mode. However, for the Difference Input Capture the timer automatically captures the elapsed time between the selected edges without the core needing to perform the calculation.

For example, the standard Input Capture mode requires that the timer be configured to capture a particular edge (rising or falling) at which time the timer's value is copied into the capture register. If the elapsed time is required, software must move the captured data into RAM and reconfigure the Input Capture mode to capture on the next edge (rising or falling). Software must then subtract the difference between the two edges to yield useful information.

The Difference Capture mode eliminates the need for software intervention and allows for capturing very short pulse or cycle widths. It can be configured to capture the elapsed time between:

- rising edge to falling edge
- rising edge to rising edge
- falling edge to rising edge
- falling edge to falling edge

Once configured, the Difference Capture timer waits for the first selected edge. When the edge transition has occurred, the 16-bit timer starts counting up based every instruction clock cycle. It will continue to count until the second selected edge transition occurs at which time the timer stops and stores the elapsed time into the T1RA register.

Software can now read the difference between transitions directly without using any processor resources. However, like

**Figure 19. Timer 0 Control Register Definition (T0CNTRL)**

Bit 7	Bit 6	Bit 5	Bit 4	Bit 3	Bit 2	Bit 1	Bit 0
WKINTEN	x	x	x	x	x	T0PND	T0INTEN

the standard Input Capture mode both the capture (T1PND) and the underflow (T1C0) flags must be monitored and handled appropriately. This feature allows the ACE<sup>x</sup> microcontroller to capture very small pulses where standard microcontrollers might have missed cycles due to the limited bandwidth.

**Figure 18. Difference Capture Mode**

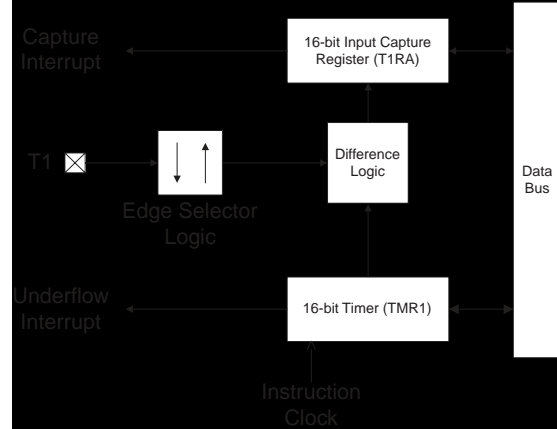

#### 5. Timer 0

Timer 0 is a 12-bit free running idle timer. Upon power-up or any reset, the timer is reset to 0x000 and then counts up continuously based on the instruction clock of 1MHz (1 μs). Software cannot read from or write to this timer. However, software can monitor the timer's pending (T0PND) bit that is set every 8192 cycles (initially 4096 cycles after a reset). The T0PND flag is set every other time the timer overflows (transitions from 0xFFFF to 0x000) through a divide-by-2 circuit. After an overflow, the timer will reset and restart its counting sequence.

Software can either poll the T0PND bit or vector to an interrupt subroutine. In order to interrupt on a T0PND, software must be sure to enable the Timer 0 interrupt enable (T0INTEN) bit in the Timer 0 control (T0CNTRL) register and also make sure the G bit is set in SR. Once the timer interrupt is serviced, software should reset the T0PND bit before exiting the routine. Timer 0 supports the following functions:

- Exiting from IDLE mode (See Section 16 for details.)
- Start up delay from HALT mode
- Watchdog pre-scalar (See Section 6 for details.)

The T0INTEN bit is a read/write bit. If set to 0, interrupt requests from the Timer 0 are ignored. If set to 1, interrupt requests are accepted. Upon reset, the T0INTEN bit is reset to 0.

The T0PND bit is a read/write bit. If set to 1, it indicates that a Timer 0 interrupt is pending. This bit is set by a Timer 0 overflow and is reset by software or system reset.

The WKINTEN bit is used in the Multi-input Wakeup/Interrupt block. See Section 8 for details.

## 6. Watchdog

The Watchdog timer is used to reset the device and safely recover in the rare event of a processor “runaway condition.” The 12-bit Timer 0 is used as a pre-scalar for Watchdog timer. The Watchdog timer must be serviced before every 61,440 cycles but no sooner than 4096 cycles since the last Watchdog reset. The Watchdog is serviced through software by writing the value 0x1B to the Watchdog Service (WDSVR) register (see Figure 20). The part resets automatically if the Watchdog is serviced too frequent, or not frequent enough.

The Watchdog timer must be enabled through the Watchdog enable bit (WDEN) in the initialization register. The WDEN bit

**Figure 20. Watchdog Service Register (WDSVR)**

Bit 7	Bit 6	Bit 5	Bit 4	Bit 3	Bit 2	Bit 1	Bit 0
0	0	0	1	1	0	1	1

## 7. Hardware Bit-Coder (Not Available on ACE1501)

The Hardware Bit-Coder is a dedicated hardware bit-encoding peripheral block, Hardware Bit-Coder (HBC), for IR/RF data transmission (see Figure 21.) The HBC is completely software programmable and can be configured to emulate various bit-encoding formats. The software developer has the freedom to encode each bit of data into a desired pattern and output the encoded data at the desired frequency through either the G2 or G5 output (TX) ports.

The HBC contains six 8-bit memory-mapped configuration registers PSCALE, HPATTERN, LPATTERN, BPSEL, HBCNTRL, and DAT0. The registers are used to select the transmission frequency, store the data bit-encoding patterns, configure the data bit-pattern/frame lengths, and control the data transmission flow.

To select the IR/RF transmission frequency, an 8-bit divide constant must be written into the IR/RF Pre-scalar (PSCALE) register. The IR/RF transmission frequency generator divides the 1MHz instruction clock down by 4 and the PSCALE register is used to select the desired IR/RF frequency shift. Together, the transmission frequency range can be configured between 976Hz (PSCALE = 0xFF) and 125kHz (PSCALE = 0x01). Upon a reset, the PSCALE register is initialized to zero disabling the IR/RF transmission frequency generator. However, once the PSCALE register is programmed, the desired IR/RF frequency is maintained as long as the device is powered.

Once the transmission frequency is selected, the data bit-encoding patterns must be stored in the appropriate registers. The HBC contains two 8-bit bit-encoding pattern registers, High-pattern (HPATTERN) and Low-pattern (LPATTERN). The encoding pattern stored in the HPATTERN register is transmitted when the data bit value to be encoded is a 1. Similarly, the pattern stored in the LPATTERN register is transmitted when the data bit value to be encoded is a 0. The HBC transmits each encoded pattern MSB first.

The number of bits transmitted from the HPATTERN and LPATTERN registers is software programmable through the Bit Period Configuration (BPSEL) register (see Figure 22). During the transmission of HPATTERN, the number of bits transmitted is configured by BPH[2:0] (BPSEL[2:0]) while BPL[2:0] (BPSEL[5:3]) configures the number of transmitted bits for the LPATTERN. The HBC allows from 2 (0x1) to 8 (0x7) encoding

can only be set while the device is in programming mode. Once set, the Watchdog will always be powered-up enabled. Software cannot disable the Watchdog. The Watchdog timer can only be disabled in programming mode by resetting the WDEN bit as long as the memory write protect (WDIS) feature is not enabled.

### WARNING

Ensure that the Watchdog timer has been serviced before entering IDLE mode because it remains operational during this time.

pattern bits to be transmitted from each register. Upon a reset, BPSEL is initially 0 disabling the HBC from transmitting pattern bits from either register.

The Data (DAT0) register is used to store up to 8 bits of data to be encoded and transmitted by the HBC. This data is shifted, bit by bit, MSB to LSB into a 1-bit decision register. If the active bit shifted into the decision register is 1, the pattern in the HPATTERN register is shifted out of the output port. Similarly, if the active bit is 0 the pattern in the LPATTERN register is shifted out.

The HBC control (HBCNTRL) register is used to configure and control the data transmission. HBCNTRL is divided in 5 different controlling signal FRAME[2:0], IOSEL, TXBUSY, START / STOP, and OCFLAG (see Figure 23.)

FRAME[2:0] selects the number of bits of DAT0 to encode and transmit. The HBC allows from 2 (0x1) to 8 (0x7) DAT0 bits to be encoded and transmitted. Upon a reset, FRAME is initialized to zero disabling the DAT0's decision register transmitting no data.

The IOSEL signal selects the transmission to output (TX) through either port G2 or G5. If IOSEL is 1, G5 is selected as the output port otherwise G2 is selected.

The TXBUSY signal is read only and is used to inform software that a transmission is in progress. TXBUSY goes high when the encoded data begins to shift out of the output port and will remain high during each consecutive DAT0 frame bit transmission (see Figure 25). The HBC will clear the TXBUSY signal when the last DAT0 encoded bit of the frame is transmitted and the STOP signal is 0.

The START / STOP signal controls the encoding and transmission process for each data frame. When software sets the START / STOP bit the DAT0 frame transmission process begins. The START signal will remain high until the beginning of the last encoded DAT0 frame bit transmission. The HBC then clears the START / STOP bit allowing software to elect to either continue with a new DAT0 frame transmission or stop the transmission all together (see Figure 25). If TXBUSY is 0 when the START signal is enabled, a synchronization period occurs before any data is transmitted lasting the amount of time to transmit a 0 encoded bit (see Figure 24).

The OCFLAG signal is read only and goes high when the last encoded bit of the DAT0 frame is transmitting. The OCFLAG signal is used to inform software that the DAT0 frame transmission operation is completing (see Figure 25). If multiple DAT0 frames are to be transmitted consecutively, software should poll the OCFLAG signal for a 1. Once OCFLAG is 1, DAT0 must be reloaded and the START / STOP bit must be restored to 1 in order to begin the new frame transmission without interruptions (the synchronization period). Since OCFLAG remains high during the entire last encoded DAT0 frame bit transmission, software should wait for the HBC to clear the OCFLAG signal before polling for the new OCFLAG high pulse. If new data is not reloaded into DAT0 and the START signal (STOP is active) is not set before the OCFLAG is 0, the transmission process will end (TXBUSY is cleared) and a new process will begin starting with the synchronization period.

Figure 24 and Figure 25 shows how the HBC performs its data encoding. In the example, two frames are encoded and transmitted consecutively with the following bit encoding format specification:

1. Transmission frequency = 62.5KHz
2. Data to be encoded = 0x52, 0x92 (all 8-bits)
3. Each bit should be encoded as a 3-bit binary value, '1' = 110b and '0' = 100b
4. Transmission output port : G2

To perform the data transmission, software must first initialize the PSCALE, BPSEL, HPATTERN, LPATTERN, and DAT0 registers with the appropriate values.

```
LD PSCALE, #03H ; (1MHz ?? 4) ?? 4 = 62.5KHz
LD BPSEL, #012H ; BPH = 2, BPL = 2 (3 bits each)
LD HPATTERN, #0C0H ; HPATTERN = 0xC0
LD LPATTERN, #090H ; LPATTERN = 0x90
LD DAT0, #052H ; DAT0 = 0x52
```

Once the basic registers are initialized, the HBC can be started. (At the same time, software must set the number of data bits per data frame and select the desired output port.)

```
LD HBCNTRL, #27H ; START / STOP = 1,
                 ; FRAME = 7, IOSEL = 0
```

After the HBC has started, software must then poll the OCFLAG for a high pulse and restore the DAT0 register and the START signal to continue with the next data transmission.

```
LOOP_HI:
IFBIT OCFLAG, HBCNTRL ; Wait for OCFLAG = 1
JP NXT_FRAME
JP LOOP_HI
```

```
NXT_FRAME:
LD DAT0, #092H ; DAT0 = 0x92
SBIT START, HBCNTRL ; START / STOP = 1
```

If software is to proceed with another data transmission, the OCFLAG must be zero before polling for the next OCFLAG high pulse. However, since the specification in the example requires no other data transmission software can proceed as desired.

```
LOOP_LO:
IFBIT OCFLAG, HBCNTRL ; Wait for OCFLAG = 0
JP LOOP_LO
Etc. ; Program proceeds as desired
```

**Figure 21. Hardware Bit-coder (HBC) Block Diagram**

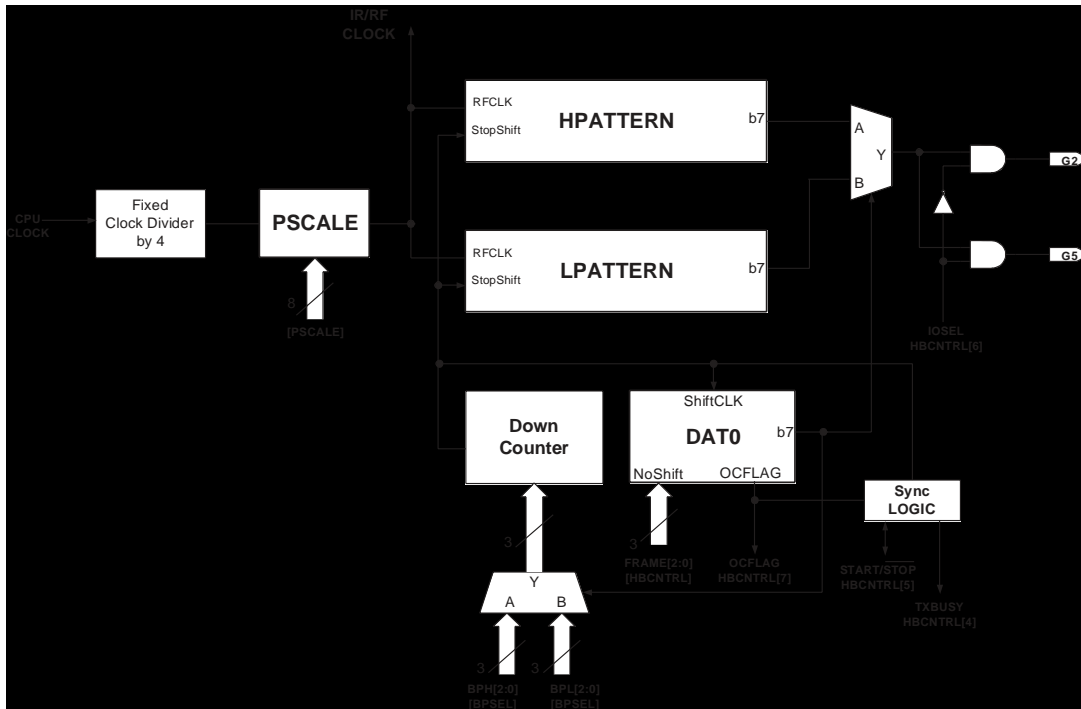

**Figure 22. Bit Period Configuration (BPSEL) Register**

Bit 7	Bit 6	Bit 5	Bit 4	Bit 3	Bit 2	Bit 1	Bit 0
0	0	BPL[2:0]			BPH[2:0]		

**Figure 23. HBC Control (HBCNTRL) Register**

Bit 7	Bit 6	Bit 5	Bit 4	Bit 3	Bit 2	Bit 1	Bit 0
OCFLAG	IOSEL	START / STOP	TXBUSY	0	FRAME[2:0]		

**Figure 24. HBC signals for one byte message in PWM format**

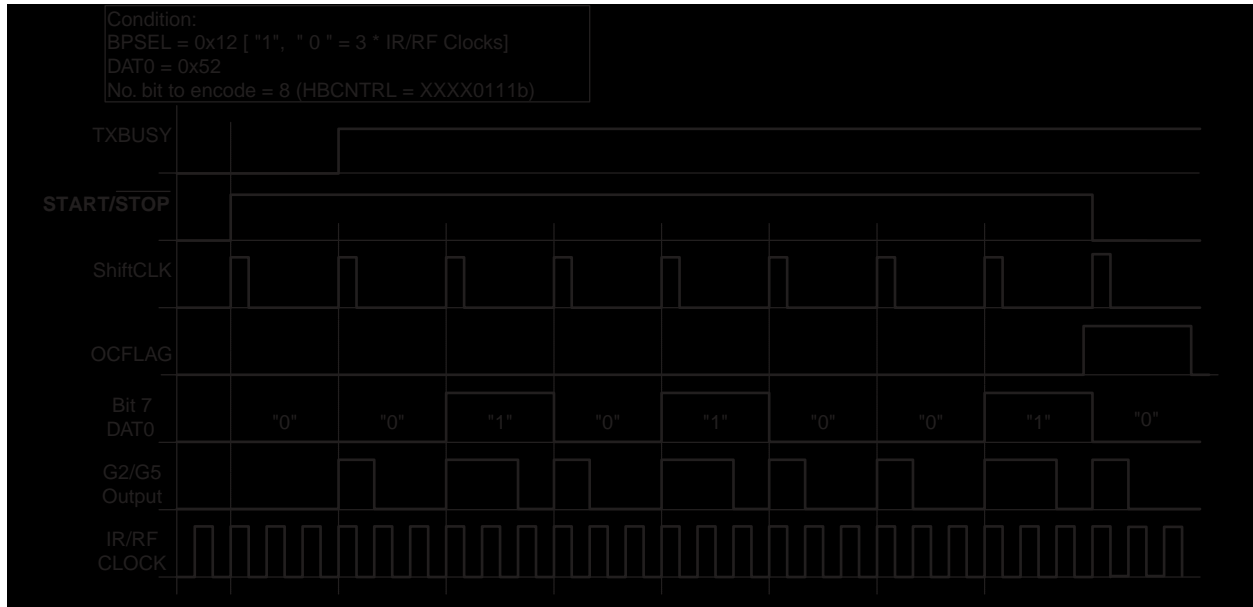

**Figure 25. Sending series of encoded messages**

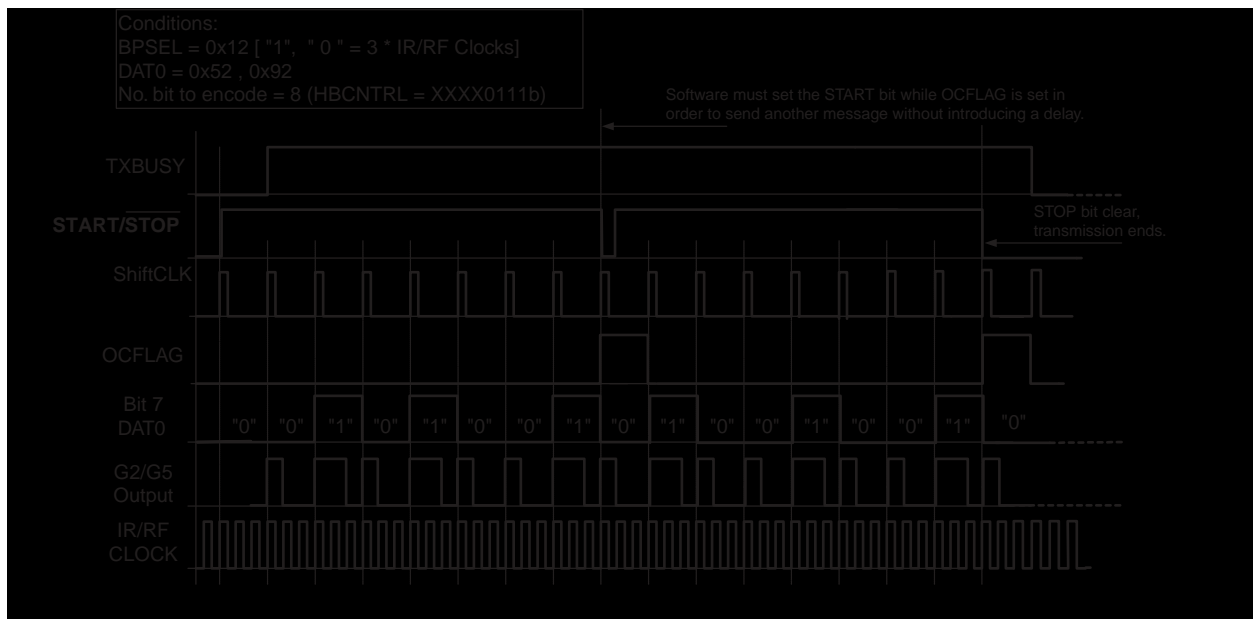

## 8. Multi-Input Wakeup/Interrupt Block

The Multi-Input Wakeup (MIW)/Interrupt contains three memory-mapped registers associated with this circuit: WKEDG (Wakeup Edge), WKEN (Wakeup Enable), and WKPND (Wakeup Pending). Each register has 8-bits with each bit corresponding to an input pins as shown in Figure 27. All three registers are initialized to zero upon reset.

The WKEDG register establishes the edge sensitivity for each of the wake-up input pin: either positive going-edge (0) or negative-going edge (1).

The WKEN register enables (1) or disables (0) each of the port pins for the Wakeup/Interrupt function. The wakeup I/Os used for the Wakeup/Interrupt function must also be configured as an input pin in its associated port configuration register. However, an interrupt of the core will not occur unless interrupts are enabled for the block via bit 7 of the TOCNTRL register (see Figure 19) and the G (global interrupt enable) bit of the SR is set.

The WKPND register contains the pending flags corresponding to each of the port pins (1 for wakeup/interrupt pending, 0 for wakeup/interrupt not pending). If an I/O is not selected to become a wakeup input, the pending flag will not be generated.

To use the Multi-Input Wakeup/Interrupt circuit, perform the steps listed below making sure the MIW edge is selected before enabling the I/O to be used as a wakeup input thus preventing false pending flag generation. This same procedure should be used following any type of reset because the wakeup inputs are left floating after resets resulting in unknown data on the port inputs.

1. Clear the WKEN register.
  - CLR WKEN
2. Clear the WKPND register to cancel any pending bits.
  - CLR WKPND
3. If necessary, write to the port configuration register to select the desired port pins to be configured as inputs.
  - RBIT 4, PORTGC ; G4
4. If necessary, write to the port data register to select the desired port pins input state.
  - SBIT 4, PORTGD ; Pull-up
5. Write the WKEDG register to select the desired type of edge sensitivity for each of the pins used.
  - LD WKEDG, #0FFH ; All negative-going edges

6. Set the WKEN bits associated with the pins to be used, thus enabling those pins for the Wakeup/Interrupt function.
  - LD WKEN, #10H ; Enabling G4

Once the Multi-Input Wakeup/Interrupt function has been configured, a transition sensed on any of the I/O pins will set the corresponding bit in the WKPND register. The WKPND bits, where the corresponding enable (WKEN) bits are set, will bring the device out of the HALT mode and can also trigger an interrupt if interrupts are enabled. The interrupt service routine can read the WKPND register to determine which pin sensed the interrupt.

The interrupt service routine or other software should clear the pending bit. The device will not enter HALT mode as long as a WKPND pending bit is pending and enabled. The user has the responsibility of clearing the pending flags before attempting to enter the HALT mode.

Upon reset, the WKEDG register is configured to select positive-going edge sensitivity for all wakeup inputs. If the user wishes to change the edge sensitivity of a port pin, use the following procedure to avoid false triggering of a Wakeup/Interrupt condition.

1. Clear the WKEN bit associated with the pin to disable that pin.
2. Clear the WKPND bit associated with the pin.
3. Write the WKEDG register to select the new type of edge sensitivity for the pin.
4. Set the WKEN bit associated with the pin to re-enable it.

PORTG provides the user with three fully selectable, edge sensitive interrupts that are all vectored into the same service subroutine. The interrupt from PORTG shares logic with the wakeup circuitry. The WKEN register allows interrupts from PORTG to be individually enabled or disabled. The WKEDG register specifies the trigger condition to be either a positive or a negative edge. The WKPND register latches in the pending trigger conditions.

Since PORTG is also used for exiting the device from the HALT mode, the user can elect to exit the HALT mode either with or without the interrupt enabled. If the user elects to disable the interrupt, then the device restarts execution from the point at which it was stopped (first instruction cycle of the instruction following HALT mode entrance instruction). In the other case, the device finishes the instruction that was being executed when the part was stopped and then branches to the interrupt service routine. The device then reverts to normal operation.

**Figure 26. Multi-input Wakeup (MIW) Register bit assignments**

WKEDG, WKEN, WKPND							
Bit 7	Bit 6	Bit 5	Bit 4	Bit 3	Bit 2	Bit 1	Bit 0
<sup>9</sup> G7	<sup>9</sup> G6	G5	G4	G3	G2	G1	G0

9. Available only on the 14-pin package option

Figure 27. Multi-input Wakeup (MIW) Block Diagram

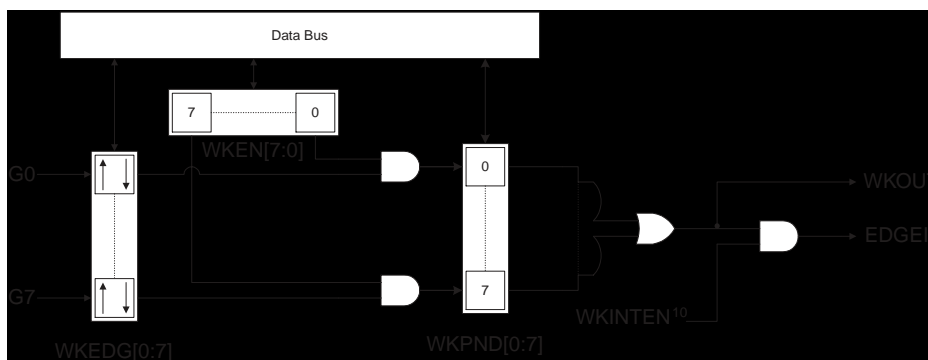

10. WKINTEN: Bit 7 of T0CNTRL

## 9. I/O Port

The eight I/O pins (six on 8-pin package option) are bi-directional (see Figure 28). The bi-directional I/O pins can be individually configured by software to operate as high-impedance inputs, as inputs with weak pull-up, or as push-pull outputs. The operating state is determined by the contents of the corresponding bits in the data and configuration registers. Each bi-directional I/O pin can be used for general purpose I/O, or in some cases, for a specific alternate function determined by the on-chip hardware.

Figure 28. PORTGD Logic Diagram

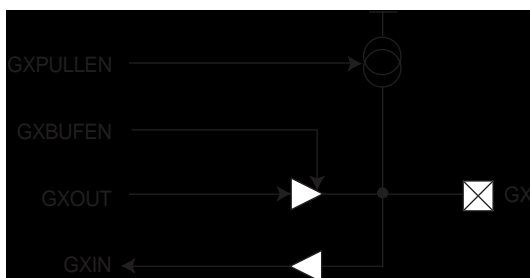

Figure 29. I/O Register bit assignments

PORTGC, PORTGD, PORTGD							
Bit 7	Bit 6	Bit 5	Bit 4	Bit 3	Bit 2	Bit 1	Bit 0
<sup>11</sup> G7	<sup>11</sup> G6	G5	G4	<sup>12</sup> G3	G2	G1	G0

11. Available only on the 14-pin package option

12. G3 after reset is an input with weak pull-up

Table 13. I/O configuration options

Configuration Bit	Data Bit	Port Pin Configuration
0	0	High-impedance input (TRI-STATE input)
0	1	Input with pull-up (weak one input)
1	0	Push-pull zero output
1	1	Push-pull one output

### 9.1 I/O registers

The I/O pins (G0-G7) have three memory-mapped port registers associated with the I/O circuitry: a port configuration register (PORTGC), a port data register (PORTGD), and a port input register (PORTGP). PORTGC is used to configure the pins as inputs or outputs. A pin may be configured as an input by writing a 0 or as an output by writing a 1 to its corresponding PORTGC bit. If a pin is configured as an output, its PORTGD bit represents the state of the pin (1 = logic high, 0 = logic low). If the pin is configured as an input, its PORTGD bit selects whether the pin is a weak pull-up or a high-impedance input. Table 13 provides details of the port configuration options. The port configuration and data registers can both be read from or written to. Reading PORTGP returns the value of the port pins regardless of how the pins are configured. Since this device supports MIW, PORTG inputs have Schmitt triggers.

## 10. In-circuit Programming Specification

The ACEx microcontroller supports in-circuit programming of the internal data EEPROM, code EEPROM, and the initialization registers.

In order to enter into program mode a 10-bit opcode (0x34B) must be shifted into the ACE1501 while the device is executing the internal power on reset ( $T_{RESET}$ ). The shifting protocol follows the same timing rules as the programming protocol defined in Figure 30.

The opcode is shifted into the ACE1501 serially, MSB first, with the data being valid by the rising edge of the clock. Once the pattern is shifted into the device, the current 10-bit pattern is matched to protocol entrance opcode of 0x34B. If the 10-bit pattern is a match, the device will enable the internal program mode flag so that the device will enter into program mode once reset has completed (see Figure 30.)

The opcode must be shifted in after  $V_{cc}$  settles to the nominal level and should end before the power on reset sequence ( $T_{Reset}$ ) completes; otherwise, the device will start normal execution of the program code. If the external reset is applied by bringing the reset pin low, once the reset pin is release the opcode may now be shifted in and again should end before the reset sequence completes.

### 10.3 Programming Protocol

After placing the device in program, the programming protocol and commands may be issued.

An externally controlled four-wire interface consisting of a LOAD control pin (G3), a serial data SHIFT-IN input pin (G4), a serial data SHIFT-OUT output pin (G2), and a CLOCK pin (G1) is used to access the on-chip memory locations. Communication between the ACEx microcontroller and the external programmer is made through a 32-bit command and response word described in Table 14. Be sure to either float or tie G5 to  $V_{cc}$  for proper programming functionality.

The serial data timing for the four-wire interface is shown in Figure 31 and the programming protocol is shown in Figure 30.

#### 10.3.1 Write Sequence

The external programmer brings the ACEx microcontroller into programming then needs to set the LOAD pin to  $V_{cc}$  before shifting in the 32-bit serial command word using the SHIFT\_IN and CLOCK signals. By definition, bit 31 of the command word is shifted in first. At the same time, the ACEx microcontroller shifts out the 32-bit serial response to the last command on the

SHIFT\_OUT pin. It is recommended that the external programmer samples this signal  $t_{ACCESS}$  (500 ns) after the rising edge of the CLOCK signal. The serial response word, sent immediately after entering programming mode, contains indeterminate data.

After 32 bits have been shifted into the device, the external programmer must set the LOAD signal to 0V, and then apply two clock pulses as shown in Figure 30 to complete program cycle.

The SHIFT\_OUT pin acts as the handshaking signal between the device and programming hardware once the LOAD signal is brought low. The device sets SHIFT\_OUT low by the time the programmer has sent the second rising edge during the LOAD = 0V phase (if the timing specifications in Figure 30 are obeyed).

The device will set the R bit of the Status register when the write operation has completed. The external programmer must wait for the SHIFT\_OUT pin to go high before bringing the LOAD signal to  $V_{cc}$  to initiate a normal command cycle.

#### 10.3.2 Read Sequence

When reading the device after a write, the external programmer must set the LOAD signal to  $V_{cc}$  before it sends the new command word. Next, the 32-bit serial command word (for during a READ) should be shifted into the device using the SHIFT\_IN and the CLOCK signals while the data from the previous command is serially shifted out on the SHIFT\_OUT pin. After the Read command has been shifted into the device, the external programmer must, once again, set the LOAD signal to 0V and apply two clock pulses as shown in Figure 30 to complete READ cycle. Data from the selected memory location, will be latched into the lower 8 bits of the command word shortly after the second rising edge of the CLOCK signal.

Writing a series of bytes to the device is achieved by sending a series of Write command words while observing the devices handshaking requirements.

Reading a series of bytes from the device is achieved by sending a series of Read command words with the desired addresses in sequence and reading the following response words to verify the correct address and data contents.

The addresses of the data EEPROM and code EEPROM locations are the same as those used in normal operation.

Powering down the device will cause the part to exit programming mode.

**Table 14 32-Bit Command and Response Word**

Bit Number	Input Command Word	Output Response Word
bits 31-30	Must be set to 0	X
bit 29	Set to 1 to read/write data EEPROM, or the initialization registers, otherwise 0	X
bit 28	Set to 1 to read/write code EEPROM, otherwise 0	X
bits 27-25	Must be set to 0	X
bit 24	Set to 1 to read, 0 to write	X
bits 23-19	Must be set to 0	X
bits 18 -8	Address of the byte to be read or written	Same as Input command word
bits 7-0	Data to be programmed or zero if data is to be read	Programmed data or data read at specified address

Figure 30. Programming Protocol<sup>13</sup>

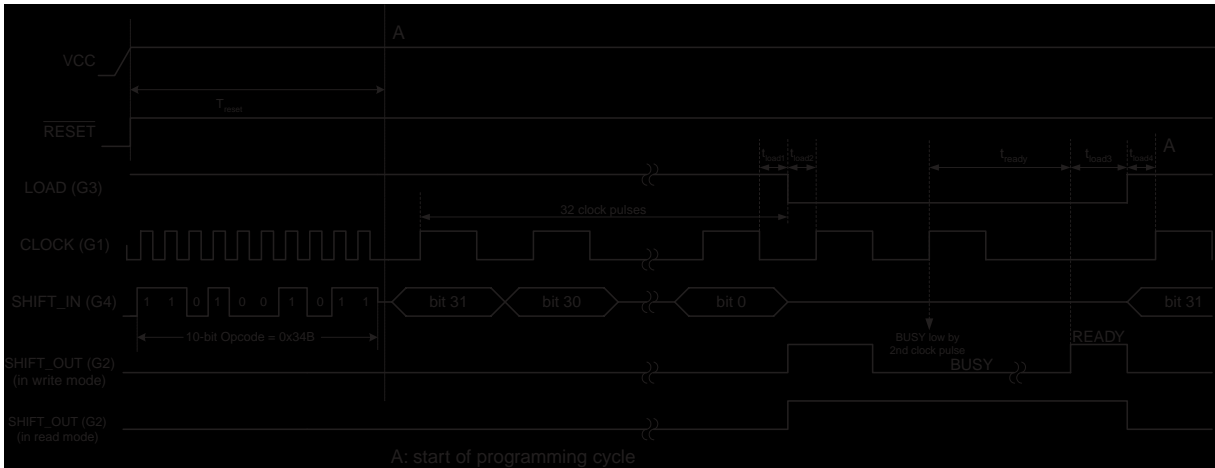

13. During in-circuit programming, G5 must be either not connected or driven high.

Figure 31. Serial Data Timing

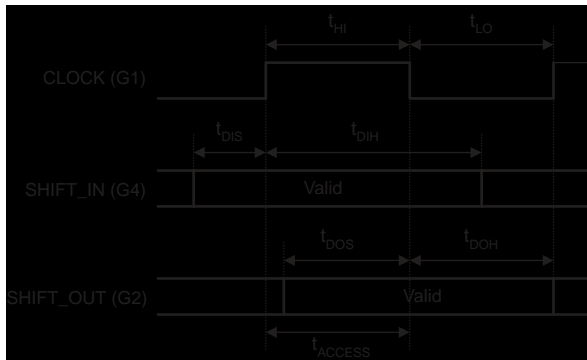

## 11. Brown-out/Low Battery Detect Circuit

The Brown-out Reset (BOR) and Low Battery Detect (LBD) circuits on the ACE<sup>x</sup> microcontroller have been designed to offer two types of voltage reference comparators. The sections below will describe the functionality of both circuits.

Figure 32. BOR/LBD Block Diagram

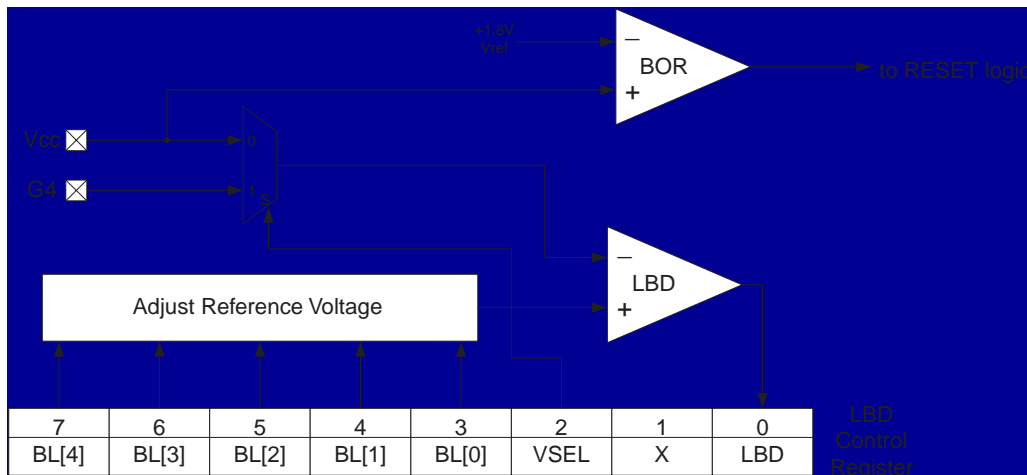



### 11.1 Brown-out Reset

The Brown-out Reset (BOR) function is used to hold the device in reset when Vcc drops below a fixed threshold (1.83V.) While in reset, the device is held in its initial condition until Vcc rises above the threshold value. Shortly after Vcc rises above the threshold value, an internal reset sequence is started. After the reset sequence, the core fetches the first instruction and starts normal operation.

The BOR should be used in situations when Vcc rises and falls slowly and in situations when Vcc does not fall to zero before rising back to operating range. The Brown-out Reset can be thought of as a supplement function to the Power-on Reset if

Vcc does not fall below ~1.5V. The Power-on Reset circuit works best when Vcc starts from zero and rises sharply. In applications where Vcc is not constant, the BOR will give added device stability.

The BOR circuit must be enabled through the BOR enable bit (BOREN) in the initialization register. The BOREN bit can only be set while the device is in programming mode. Once set, the BOR will always be powered-up enabled. Software cannot disable the BOR. The BOR can only be disabled in programming mode by resetting the BOREN bit as long as the global write protect (WDIS) feature is not enabled.

**Figure 33. BOR and POR Circuit Relationship Diagram**

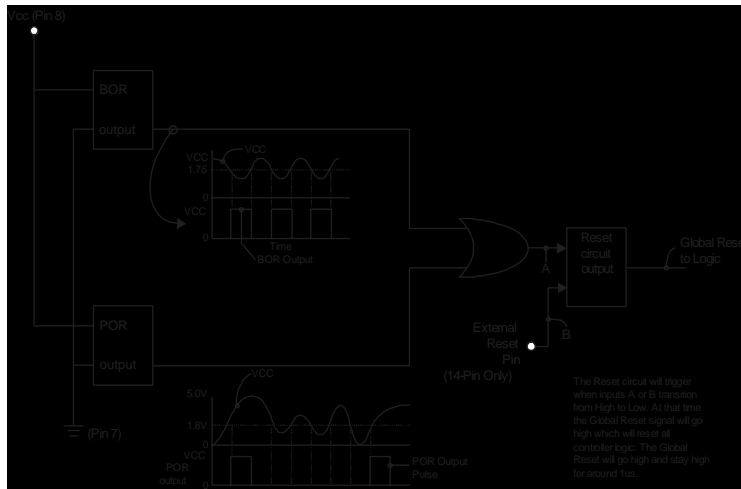

### 11.2 Low Battery Detect

The Low Battery Detect (LBD) circuit allows software to monitor the Vcc level at the lower voltage ranges. LBD has a 32-level software programmable voltage reference threshold that can be changed on the fly. Once Vcc falls below the selected threshold, the LBD flag in the LBD control register is set. The LBD flag will hold its value until Vcc rises above the threshold. (See Table 15)

The LBD bit is read only. If LBD is 0, it indicates that the Vcc level is higher than the selected threshold. If LBD is 1, it indicates that the Vcc level is below the selected threshold. The threshold level can be adjusted up to eight levels using the three trim bits (BL[4:0]) of the LBD control register. The LBD flag does not cause any hardware actions or an interruption of the processor. It is for software monitoring only.

The VSEL bit of the LBD control register can be used to select an external voltage source rather than Vcc. If VSEL is 1, the voltage source for the LBD comparator will be an input voltage provided through G4. If VSEL is 0, the voltage source will be Vcc.

The LBD circuit must be enabled through the LBD enable bit (LBDEN) in the initialization register. The LBDEN bit can only be set while the device is in programming mode. Once set, the LBD will always be powered-up enabled. Software cannot disable the LBD. The LBD can only be disabled in programming mode by

resetting the LBDEN bit as long as the global write protect (WDIS) feature is not enabled.

The LBD circuit is disabled during HALT/IDLE mode. After exiting HALT/IDLE, software must wait at least 10 μs before reading the LBD bit to ensure that the internal circuit has stabilized.

Table 15. LBD Control Register Definition

Bit 7	Bit 6	Bit 5	Bit 4	Bit 3	Bit 2	Bit 1	Bit 0
BL[4:0]					VSEL	X	LBD
Level	BL[4]	BL[3]	BL[2]	BL[1]	BL[0]	Voltage Reference Range (Typical)	
1	0	0	0	0	0	1.81V	
2	0	0	0	0	1	1.87V	
3	0	0	0	1	0	1.93V	
4	0	0	0	1	1	1.99V	
5	0	0	1	0	0	2.05V	
6	0	0	1	0	1	2.11V	
7	0	0	1	1	0	2.17V	
8	0	0	1	1	1	2.23V	
9	0	1	0	0	0	2.29V	
10	0	1	0	0	1	2.36V	
11	0	1	0	1	0	2.42V	
12	0	1	0	1	1	2.48V	
13	0	1	1	0	0	2.54V	
14	0	1	1	0	1	2.60V	
15	0	1	1	1	0	2.66V	
16	0	1	1	1	1	2.72V	
17	1	0	0	0	0	2.77V	
18	1	0	0	0	1	2.84V	
19	1	0	0	1	0	2.91V	
20	1	0	0	1	1	2.97V	
21	1	0	1	0	0	3.03V	
22	1	0	1	0	1	3.09V	
23	1	0	1	1	0	3.16V	
24	1	0	1	1	1	3.22V	
25	1	1	0	0	0	3.28V	
26	1	1	0	0	1	3.34V	
27	1	1	0	1	0	3.41V	
28	1	1	0	1	1	3.47V	
29	1	1	1	0	0	3.54V	
30	1	1	1	0	1	3.60V	
31	1	1	1	1	0	3.67V	
32	1	1	1	1	1	3.73V	

## 12. RESET block

When a RESET sequence is initiated, all I/O registers will be reset setting all I/Os to high-impedance inputs. The system clock is restarted after the required clock start-up delay. A reset is generated by any one of the following four conditions:

- Power-on Reset (as described in Section 13)
- Brown-out Reset (as described in Section 11.1)
- Watchdog Reset (as described in Section 6)
- External Reset <sup>18</sup> (as described in Section 13)

18. Available only on the 14-pin package option

## 13. Power-On Reset

The Power-On Reset (POR) circuit is guaranteed to work if the rate of rise of Vcc is no slower than 10ms/1volt. The POR circuit was designed to respond to fast low to high transitions between 0V and Vcc. The circuit will not work if Vcc does not drop to 0V before the next power-up sequence. In applications where 1) the Vcc rise is slower than 10ms/1 volt or 2) Vcc does not drop

to 0V before the next power-up sequence the external reset option should be used.

The external reset provides a way to properly reset the ACEx microcontroller if POR cannot be used in the application. The external reset pin contains an internal pull-up resistor. Therefore, to reset the device the reset pin should be held low for at least 2ms so that the internal clock has enough time to stabilize.

## 14. CLOCK

The ACEx microcontroller has an on-board oscillator trimmed to a frequency of 2MHz who is divided down by two yielding a 1MHz frequency. (See AC Electrical Characteristics) Upon power-up, the on-chip oscillator runs continuously unless entering HALT mode or using an external clock source.

If required, an external oscillator circuit may be used depending on the states of the CMODE bits of the initialization register. (See Table 16) When the device is driven using an external clock, the clock input to the device (G1/CKI) can range between DC to 4MHz. For external crystal configuration, the output clock (CKO) is on the G0 pin. (See Figure 34.) If the device is configured for an external square clock, it will not be divided.

Figure 34. Crystal

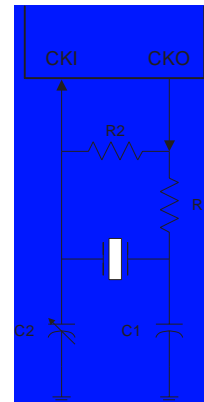

Table 16. CMODEX Bit Definition

CMODE [1]	CMODE [0]	Clock Type
0	0	Internal 1 MHz clock
0	1	External square clock
1	0	External crystal/resonator
1	1	Reserved

## 15. HALT Mode

The HALT mode is a power saving feature that almost completely shuts down the device for current conservation. The device is placed into HALT mode by setting the HALT enable bit (EHALT) of the HALT register through software using only the "LD M, #" instruction. EHALT is a write only bit and is automatically cleared upon exiting HALT. When entering HALT, the internal oscillator and all the on-chip systems including the LBD and the BOR circuits are shut down.

The device can exit HALT mode only by the MIW circuit. Therefore, prior to entering HALT mode, software must configure the MIW circuit accordingly. (See Section 8) After a wakeup from HALT, a 1ms start-up delay is initiated to allow the internal oscillator to stabilize before normal execution resumes. Immediately after exiting HALT, software must clear the Power Mode Clear (PMC) register by only using the "LD M, #" instruction. (See Figure 36)

Figure 35. HALT Register Definition

Bit 7	Bit 6	Bit 5	Bit 4	Bit 3	Bit 2	Bit 1	Bit 0
Undefined	undefined	undefined	undefined	undefined	undefined	EIDLE	EHALT

**Figure 36. Recommended HALT Flow**

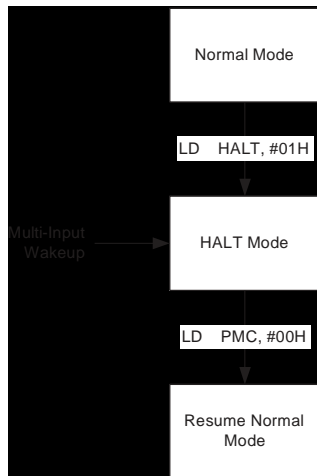

## 16. IDLE Mode

In addition to the HALT mode power saving feature, the device also supports an IDLE mode operation. The device is placed into IDLE mode by setting the IDLE enable bit (EIDLE) of the HALT register through software using only the “LD M, #” instruction. EIDLE is a write only bit and is automatically cleared upon exiting IDLE. The IDLE mode operation is similar to HALT except the internal oscillator, the Watchdog, and the Timer 0 remain active while the other on-chip systems including the LBD and the BOR circuits are shut down.

The device automatically wakes from IDLE mode by the Timer 0 overflow every 8192 cycles (see Section 5). Before entering IDLE mode, software must clear the WKEN register to disable the MIW block. Once a wake from IDLE mode is triggered, the core will begin normal operation by the next clock cycle. Immediately after exiting IDLE mode, software must clear the Power Mode Clear (PMC) register by using only the “LD M, #” instruction. (See Figure 37.)

**Figure 37. Recommended IDLE Flow**

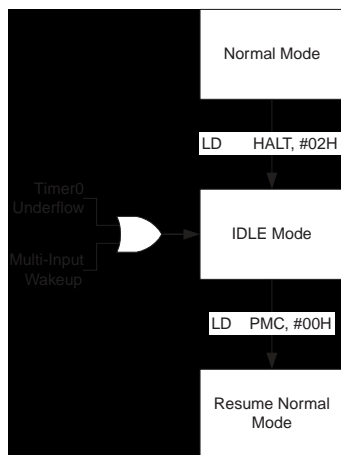

## Ordering Information

Part Number	Core Type				Max.# I/Os	Program Memory Size		Operating Voltage Range 1.8 – 3.6V	Package						Tape & Reel		
	0	1	2	5		8	2K		1K	-40 to +85°C	-40 to +125°C	8-pin SOIC	14-pin SOIC	8-pin DIP		14-pin DIP	8-pin TSSOP
ACE1501EM8				X	X		X	X	X		X						
ACE1501EM8X				X	X		X	X	X		X						X
ACE1501EM				X	X		X	X	X			X					
ACE1501EMX				X	X		X	X	X			X					X
ACE1501EMT8				X	X		X	X	X						X		
ACE1501EMT8X				X	X		X	X	X						X		X
ACE1501EMT				X	X		X	X	X							X	
ACE1501EMTX				X	X		X	X	X							X	X
ACE1501EN				X	X		X	X	X				X				
ACE1501EN14				X	X		X	X	X					X			
ACE1501VM8				X	X		X	X		X	X						
ACE1501VM8X				X	X		X	X		X	X						X
ACE1501VM				X	X		X	X				X					
ACE1501VMX				X	X		X	X				X					X
ACE1501VMT8				X	X		X	X		X					X		
ACE1501VMT8X				X	X		X	X		X					X		X
ACE1501VMT				X	X		X	X		X						X	
ACE1501VMTX				X	X		X	X		X						X	X
ACE1501VN				X	X		X	X					X				
ACE1501VN14				X	X		X	X		X				X			

**Physical Dimensions** inches (millimeters) unless otherwise noted)

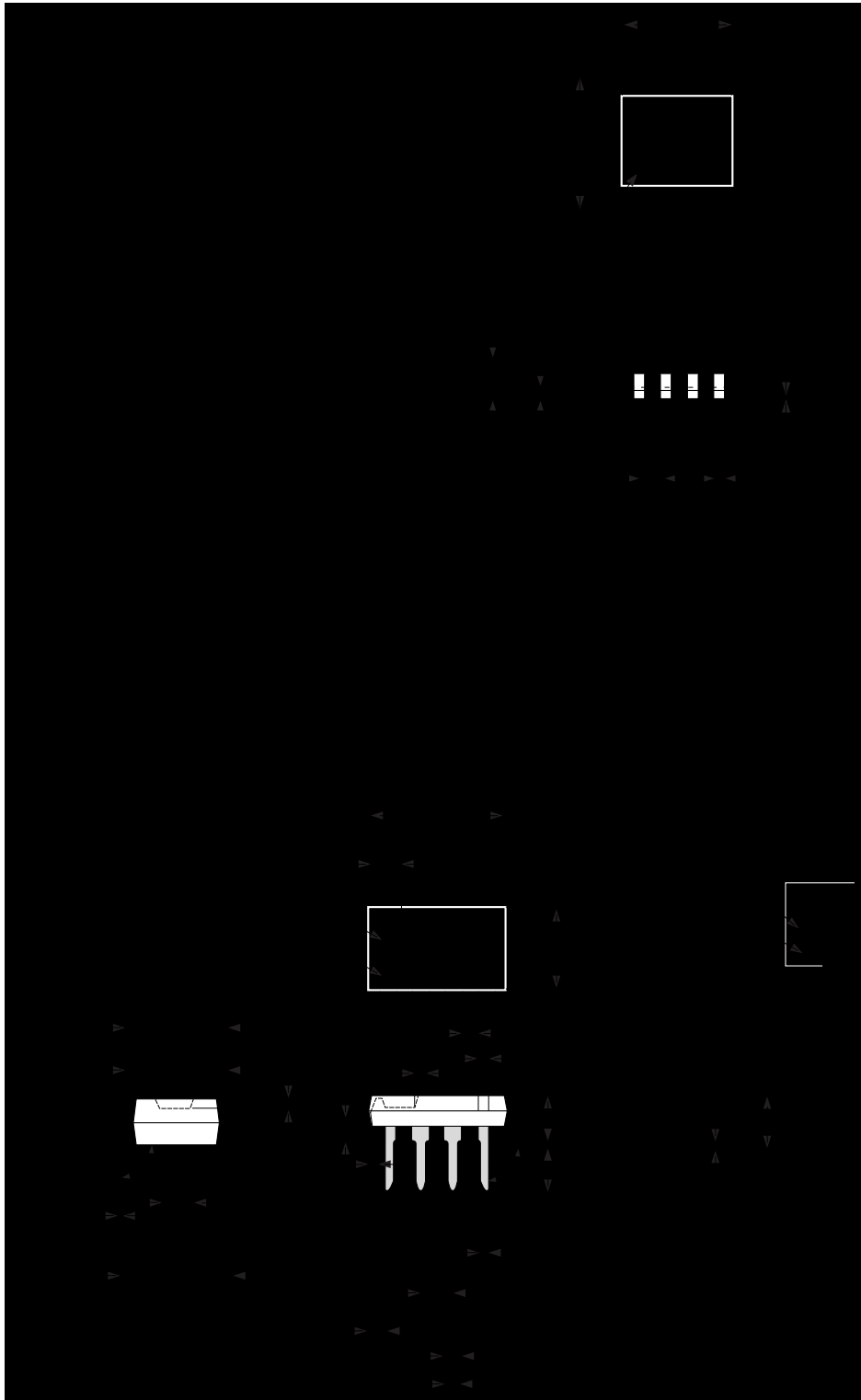

8-Pin DIP (N)  
Order Number ACE1501EN/ACE1501VN  
Package Number N08A

**Physical Dimensions** inches (millimeters) unless otherwise noted)



**14-Pin TSSOP**  
**Order Number ACE1501EMT/ACE1501VMT**  
**Package Number MT14A**

Physical Dimensions inches (millimeters) unless otherwise noted



**14-Pin DIP (N14)**  
**Order Number ACE1501EN14/ACE1501VN14**  
**Package Number N14A**



## ACE<sup>™</sup> Development Tools

### General Information:

Fairchild Semiconductor offers different possibilities to evaluate and emulate software written for ACE<sup>™</sup>.

**Simulator:** Is a Windows program able to load, assemble, and debug ACE<sup>™</sup> programs. It is possible to place as many breakpoints as needed, trace the program execution in symbolic format, and program a device with the proper options. The ACE<sup>™</sup> Simulator is available free-of-charge and can be downloaded from Fairchild's web site at [www.fairchildsemi.com/products/memory/ace](http://www.fairchildsemi.com/products/memory/ace)



**ACE<sup>™</sup> Emulator Kit:** Fairchild also offers a low cost real-time in-circuit emulator kit that includes:

- Emulator board
- Emulator software
- Assembler and Manuals
- Power supply
- DIP14 target cable
- PC cable

The ACE<sup>™</sup> emulator allows for debugging the program code in a symbolic format. It is possible to place one breakpoint and watch various data locations. It also has built-in programming capability.

**Prototype Board Kits:** Fairchild offers two solutions for the simplification of the breadboard operation so that ACE<sup>™</sup> Applications can be quickly tested.

- 1) ACEDEMO can be used for general purpose applications
- 2) ACETXRX is for transmitting / receiving (RF, IR, RS232, RS485) applications.

ACEDEMO has 8 switches, 8 LEDs, RS232 voltage translator, buzzer, and a lamp with a small breadboard area.

### Factory Programming:

Fairchild offers factory pre-programming and serialization (for justified quantities) for a small additional cost. Please refer to your local distributor for details regarding factory programming.

### Ordering P/Ns

Emulator Kit and Programming adapters:

Please refer to your local distributor for details regarding development tools.

## Life Support Policy

Fairchild's products are not authorized for use as critical components in life support devices or systems without the express written approval of the President of Fairchild Semiconductor Corporation. As used herein:

1. Life support devices or systems are devices or systems which, (a) are intended for surgical implant into the body, or (b) support or sustain life, and whose failure to perform, when properly used in accordance with instructions for use provided in the labeling, can be reasonably expected to result in a significant injury to the user.
2. A critical component is any component of a life support device or system whose failure to perform can be reasonably expected to cause the failure of the life support device or system, or to affect its safety or effectiveness.

**Fairchild Semiconductor  
Americas  
Customer Response Center**  
Tel: 1-888-522-5372

**Fairchild Semiconductor  
Europe**  
Fax: +44 (0) 1793-856858  
Tel: +49 (0) 8141-6102-0  
English Tel: +44 (0) 1793-856856  
Français Tel: +33 (0) 1-6930-3696  
Italiano Tel: +39 (0) 2-249111-1

**Fairchild Semiconductor  
Hong Kong**  
8/F, Room 808, Empire Centre  
68 Mody Road, Tsimshatsui East  
Kowloon, Hong Kong  
Tel: +852-2722-8338  
Fax: +852-2722-8383

**Fairchild Semiconductor  
Japan Ltd.**  
4F, Natsume Bldg.  
2-18-6, Yushima, Bunkyo-ku  
Tokyo, 113-0034 Japan  
Tel: 81-3-3818-8840  
Fax: 81-3-3818-8841