

The copying, distribution and utilization of this document as well as the communication of the contents to others without expressed authorization is prohibited according to §18 UWG German Law. Offenders will be held liable for the payment of damages according to §19 UWG German Law. All rights reserved, in particular the right to carry out patent, utility model or ornamental design registrations.

Weitergabe sowie Vervielfältigung dieses Dokuments, Verwertung und Mitteilung seines Inhalts gem §18 UWG verboten, soweit nicht ausdrücklich gestattet. Zuwiderhandlungen verpflichten zu Schadenersatz (§19 UWG). Alle Rechte vorbehalten, insbesondere das Recht, Patent-, Gebrauchsmuster- oder Geschmacksmusteranmeldungen durchzuführen. PHOENIX CONTACT Connector Technology GmbH, Heisenbergstrasse 1, D-71083 Herrenberg

Mechanical data (according to IEC 61076-2-101)	
Locking thread	M12x1 STANDARD
Material	
threaded sleeve	GD-Zn, nickel plated
sealing gasket	FKM
housing socket	PA66
temperature range	-40 °C to +85 °C

further information:
 - see installation recommendation
 SACC-BP-F-M12/VAR-...9TIP

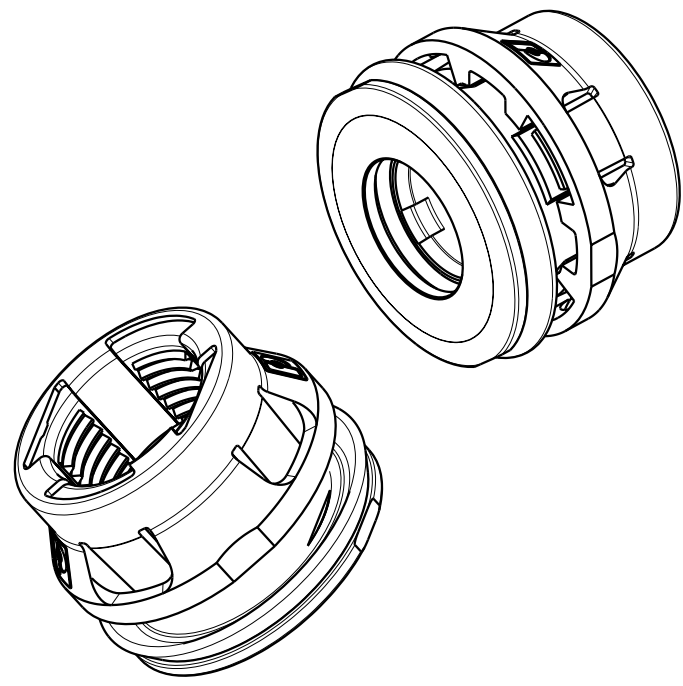
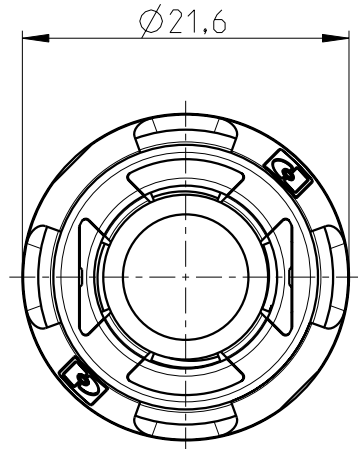
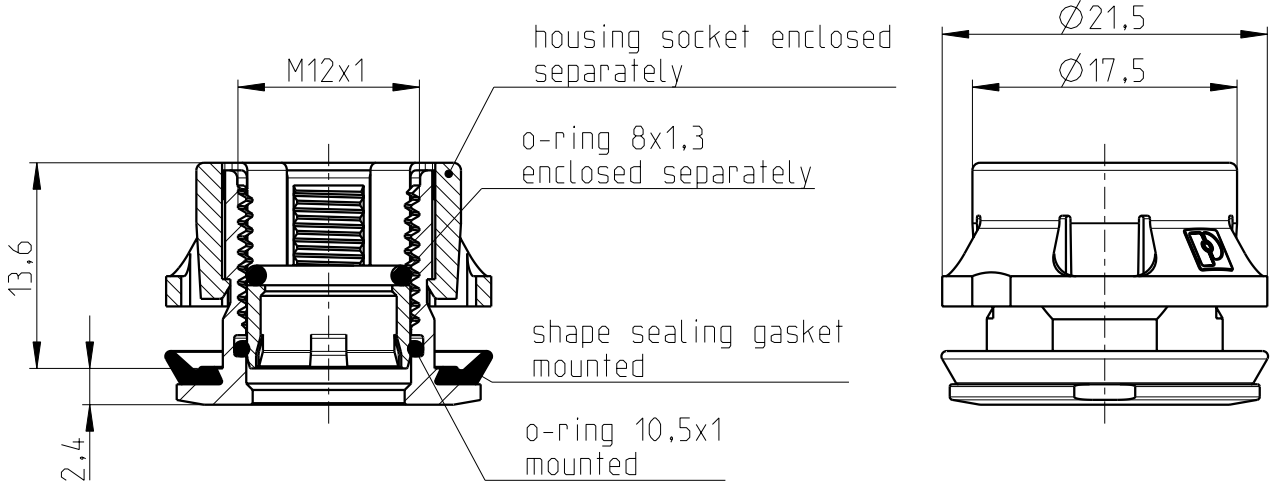

All specified data refers to the mounted M12 installation plugs \geq IP54 and requires that the connector pair be correctly plugged and locked. Recommended tightening torque 0,4Nm. Influences from wires, cables or PCB mounting are also to be taken into consideration.

general tolerance acc. to DIN ISO 2768-c		technical changes reserved		Index 2 / 2015-03-03		scale: 2:1	
design	date	name		Series DSIV M12 offset housing 9mm / 3,1mm to 3,9mm / shape sealing gasket			
chk.	2014-06-04	Scheerer					
		drawing-no.:	BS-0000000T300		doc.-no.:	00798025	
		order-no.:	1414234		page: 1 of: 1		
		article designation:	SACC-BP-F-M12/VAR-3,1/3,9-9TIP				