

## PROPER USE GUIDELINES

Cumulative Trauma Disorders can result from the prolonged use of manually powered hand tools. AMP hand tools are intended for occasional use and low volume applications. AMP offers a wide selection of powered application equipment for extended-use, production operations.

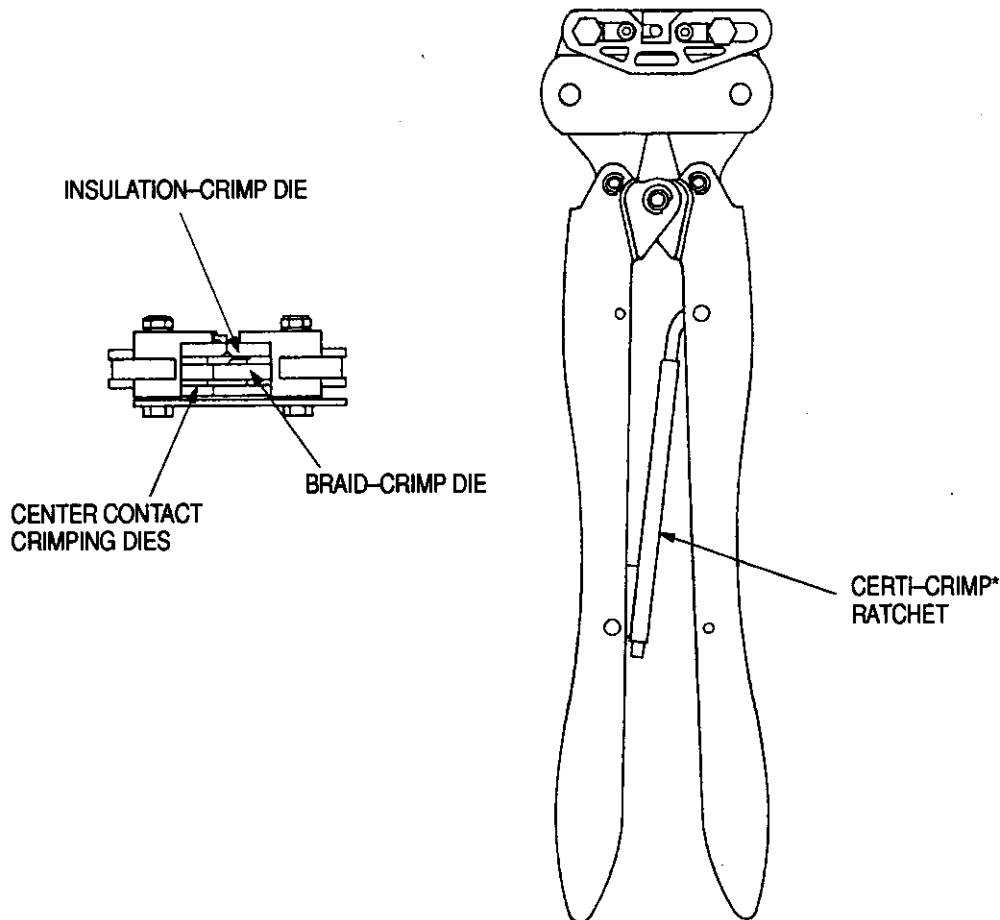

Figure 1

94-82

## 1. INTRODUCTION

This instruction sheet covers the use of AMP Hand Crimping Tool 58290-1 (see Figure 1) which is designed to apply AMP Miniature COAXICON Pin and Socket Contacts to double braided coaxial cables. Contacts and cables are listed in Figure 2. Read these instructions thoroughly before using the tool.

Reasons for reissue are provided in Section 6, REVISION SUMMARY.

### NOTE

*Dimensions on this sheet are in millimeters [with inches in brackets].*

## 2. DESCRIPTION

The tool (shown in Figure 1) features three sets of crimping dies, a locator, and a CERTI-CRIMP ratchet.

One die set crimps the center conductor to the inner wire barrel; another set crimps the ferrule to the braid; and the other set crimps the ferrule to the insulation. Crimping is accomplished simultaneously with one crimping cycle of the tool.

The locator aids in positioning the pin or socket in the tool head.

The CERTI-CRIMP ratchet assures full crimping of the contact. Once engaged, the ratchet will not release until the handles have FULLY closed.

### CAUTION

*The crimping dies bottom before the CERTI-CRIMP ratchet releases. This design feature assures maximum electrical and tensile performance of the crimp. Do NOT re-adjust the ratchet.*

RETENTION SPRING NO. 201142-2 IS COMMON TO ALL SOCKET AND PIN ASSEMBLIES.

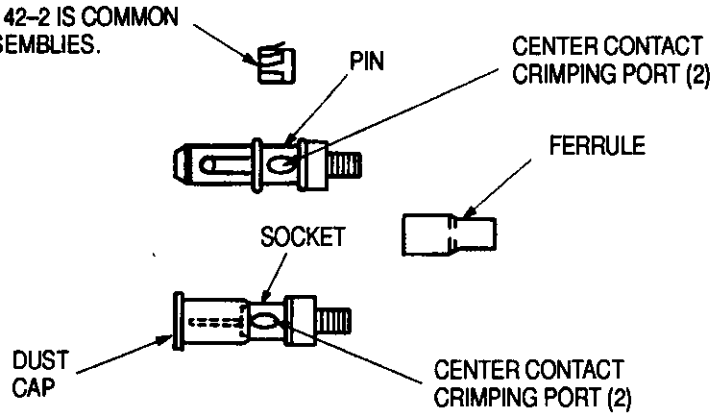

CABLE NUMBER	CONTACT PART NUMBER		PART NUMBER FERRULE	CABLE STRIP DIMENSIONS
	SOCKET	PIN		
RG-316	201144-5	201143-5	221848-3	See Figure 3
RG-179/187	201144-1	201143-1		

Figure 2

67-42

**3. CRIMPING PROCEDURE**

**NOTE** Each hand tool is coated with a preservative to prevent rust or corrosion. Wipe this preservative from the tool, particularly from the crimping jaws, before using the tool.

The crimping procedure requires two separate steps. First, the cable must be prepared for crimping; then the contact and cable are crimped in the tool.

**3.1. Cable Preparation**

Make certain that the contact to be crimped is compatible with the cable (refer to Figure 2). Then refer to Figure 3, and proceed as follows:

1. Slide ferrule –folded end first– on cable (refer to Figure 3).
2. Strip cable to dimensions shown in Figure 3 (do NOT cut or nick braid or center conductor).

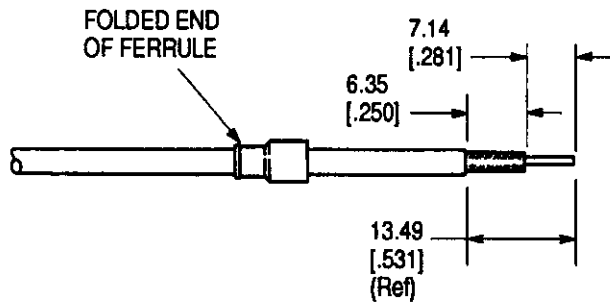

Figure 3

67-43

3. Insert center conductor into pin or socket contact as far as it will go. Braid must pass over and around support sleeve.
4. Slide ferrule forward and over braid until ferrule bottoms against shoulder on contact. Assembly is now ready to be crimped.

**3.2. Crimping the Contact Assembly**

To crimp the contact assembly, refer to Figure 4 and proceed as follows:

1. Open the tool's crimping dies by squeezing the handles until the ratchet releases and then allow the handles to open FULLY.

**NOTE** The dust cap (on socket contacts) should not be removed. Leave the dust cap in the socket until the socket is ready to be inserted into the connector.

2. Position the contact assembly in the crimping dies, as shown in Figure 4. The locator aids in positioning the crimping ports of the contact so that the lower center contact crimping die enters the bottom crimping port. Once located, push the contact down so that the lower center contact crimping die enters the bottom crimping port of the contact.

3. Ensure that the ferrule remains bottomed firmly on the crimping dies and that the upper center contact crimping die is aligned with the upper center contact crimping port.

4. While holding the contact assembly in place, close handles until ratchet releases. Allow handles to open and remove crimped contact.

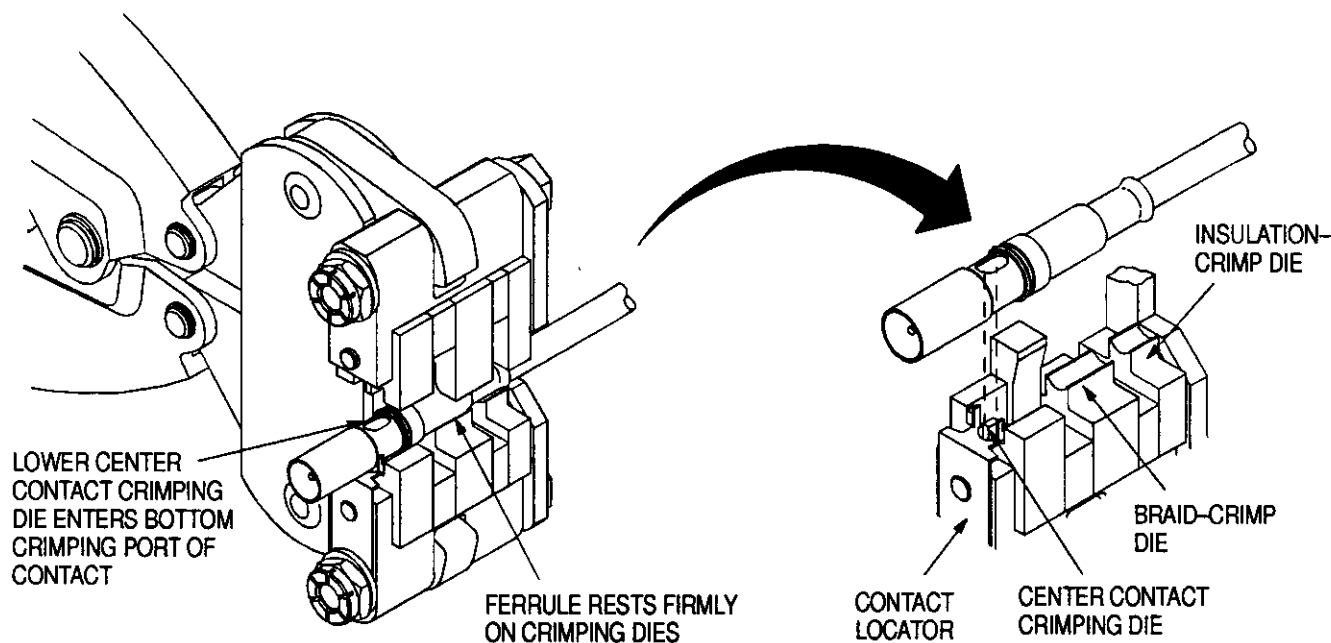

Figure 4

**NOTE**

Once the assembly is crimped, the retention spring may be attached and the assembly inserted into the connector. Refer to AMP Instruction Sheet 408-1770 for information on attaching the retention spring and for insertion and extraction procedures.

**4. MAINTENANCE AND INSPECTION PROCEDURE**

AMP recommends that a maintenance and inspection program be performed periodically to ensure dependable and uniform terminations. Frequency of inspection depends on:

1. The care, amount of use, and handling of the hand tool.
2. The presence of abnormal amounts of dust and dirt.
3. The degree of operator skill.
4. Your own established standards.

The hand tool is inspected before being shipped; however, AMP recommends that the tool be inspected immediately upon its arrival at your facility to ensure that the tool has not been damaged during shipment. Due to the precision design, it is important that no parts of these tools be interchanged except those replacement parts listed in Figure 6.

**4.1. Daily Maintenance**

1. Remove dust, moisture, and other contaminants with a clean brush, or a soft, lint-free cloth. Do NOT use objects that could damage the tool.
2. Make certain that the retaining pins are in place and that they are secured with retaining rings.

3. All pins, pivot points, and bearing surfaces should be protected with a thin coat of any good SAE No. 20 motor oil. Do not oil excessively.

4. When the tool is not in use, keep handles closed to prevent objects from becoming lodged in the crimping dies. Store the tool in a clean, dry area.

**4.2. Lubrication**

Lubricate all pins, pivot points, and bearing surfaces with SAE No. 20 motor oil as follows:

Tools used in daily production – lubricate daily  
 Tools used daily (occasional) – lubricate weekly  
 Tools used weekly – lubricate monthly

Wipe excess oil from tool, particularly from crimping area. Oil transferred from the crimping area onto certain terminations may affect the electrical characteristics of an application.

**4.3. Periodic Inspection**

1. Hand tool should be immersed (handles partially closed) in a reliable commercial degreasing compound to remove accumulated dirt, grease, and foreign matter.
2. Close tool handles until ratchet releases and then allow them to open freely. If they do not open quickly and fully, the spring is defective and must be replaced. See Section 5, REPLACEMENT AND REPAIR.
3. Inspect head assembly for worn, cracked, or broken dies. If damage is evident, return the tool to AMP for evaluation and repair. See Section 5, REPLACEMENT AND REPAIR.

**4.4. Crimping Die Closure Inspection**

This inspection requires the use of three plug gages conforming to the dimensions shown in Figure 5. AMP does not manufacture or market these gages.

To gage die closure, proceed as follows:

1. Remove traces of oil or dirt from the crimping chamber and plug gage.
2. Close the tool handles until it is evident that the dies have bottomed; then hold in this position. Do NOT force the dies beyond initial contact.

3. Align the center contact gage GO element with the center contact crimping chamber. Push element straight into the crimping chamber without using force. The GO element must pass completely through the crimping chamber.

4. Check the center contact crimping chamber with the NO-GO element in the same manner as step 3. The NO-GO element may start entry, but must not pass completely through the crimping chamber.

5. Check the GO and NO-GO conditions of the insulation crimping chamber in the same manner as Steps 3 and 4, using the insulation crimp plug gage.

**PLUG GAGE — CENTER CONTACTS**

DIE CLOSURE CONFIGURATION

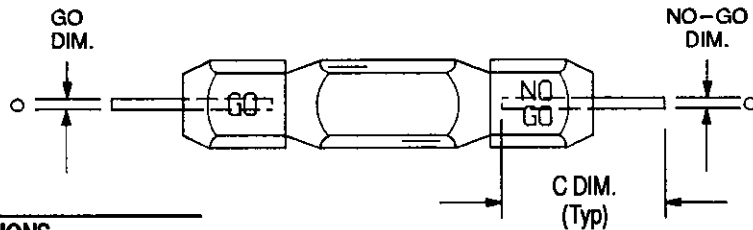

**GAGE ELEMENT DIMENSIONS**

GO	NO-GO	C
.93 - .94 [.0370 - .0373]	1.01 - 1.02 [.0399 - .0400]	50.8 [2.00]

**PLUG GAGE — BRAID CRIMP**

DIE CLOSURE CONFIGURATION

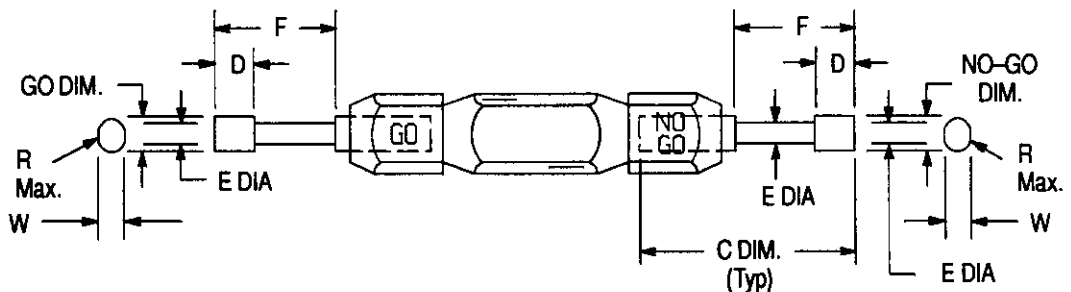

**GAGE ELEMENT DIMENSIONS**

F	D	GO	NO-GO	E DIA	W (Max.)	C	R (Max.)
12.7 [.500]	2.29 [.090]	3.55 - 3.56 [.1400 - .1403]	3.65 - 3.66 [.1439 - .1440]	2.08 [.082]	3.25 [.128]	25.4 [1.00]	1.63 [.064]

**PLUG GAGE — INSULATION CRIMP**

DIE CLOSURE CONFIGURATION

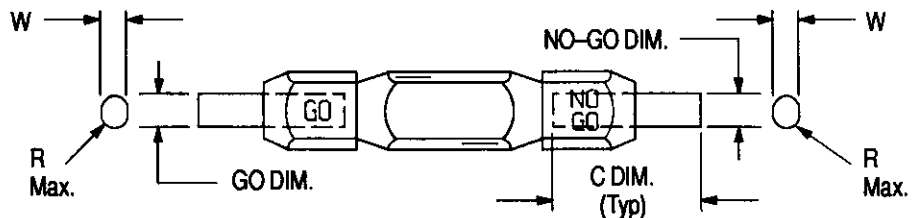

**GAGE ELEMENT DIMENSIONS**

GO	NO-GO	W (Max.)	C	R (Max.)
3.35 - 3.36 [.1320 - .1323]	3.45 - 3.46 [.1359 - .1360]	3.15 [.124]	25.4 [1.00]	1.57 [.062]

Figure 5

6. Open the tool's crimping dies by squeezing the handles until the ratchet releases and then allow the handles to open fully.
7. Carefully insert the braid crimp gage GO element between the center contact and braid crimping chambers. Slowly close the tool handles until the dies bottom while making certain that the GO element does not become lodged in the crimping dies.
8. Align the GO element with the braid crimping chamber and pull element straight into the chamber without using force. The GO element must pass completely through the crimping chamber.
9. Check the NO-GO conditions of the braid crimping chamber by repeating Steps 6, 7 and 8 using the braid crimp gage NO-GO element.

If die closures conforms to the gage inspections, the crimping chambers are considered dimensionally correct. If correct, the tool should be lubricated with a thin coat of any good SAE No. 20 motor oil and returned to service. If not correct, the tool must be returned to AMP for further evaluation and repair. Refer to Section 5, REPLACEMENT AND REPAIR. For additional information regarding the use of a plug gage, refer to AMP instruction sheet 408-7424.

#### 4.5. CERTI-CRIMP Ratchet Inspection

The CERTI-CRIMP ratchet feature on AMP hand tools should be checked to ensure that the ratchet does not release prematurely, allowing the crimping dies to open before they have fully bottomed. Obtain a 0.025-mm [.001-in.] shim that is suitable for checking the clearance between the bottoming surfaces of the crimping dies. Proceed as follows:

1. Select an appropriate contact.
2. Position the contact and properly stripped cable between the crimping dies, as described in Section 3, CRIMPING PROCEDURE.
3. Hold the contact and wire in place and squeeze the handles until the CERTI-CRIMP ratchet

releases. Hold the handles in this position, maintaining just enough tension to keep the dies closed.

4. Check the clearance between the bottoming surfaces of the crimping dies. If the clearance is 0.025 mm [.001 in.] or less, the ratchet is satisfactory. If clearance exceeds 0.025 mm [.001 in.], the ratchet is out of adjustment and must be repaired. See Section 5, REPLACEMENT AND REPAIR.

#### 5. REPLACEMENT AND REPAIR

Replacement parts are listed in Figure 6. Parts other than those listed in Figure 6 should be replaced by AMP to ensure quality and reliability of the tool. Order replacement parts through your AMP representative, or call 1-800-526-5142, or send a facsimile of your purchase order to 1-717-986-7605, or write to:

CUSTOMER SERVICE (38-35)  
AMP INCORPORATED  
P.O. BOX 3608  
HARRISBURG, PA 17105-3608

For tool repair service or CERTI-CRIMP ratchet adjustment, return the tool, with a written description of the problem, to:

CUSTOMER REPAIR (01-12)  
AMP INCORPORATED  
1523 NORTH 4TH STREET  
HARRISBURG, PA 17102-1604

#### 6. REVISION SUMMARY

Since the previous release, the following changes and additions were made to this document:

Per EC 0150-4095-92:

- Changed part number of item 4 in Figure 6
- Added item 9 in Figure 6

Per EC 0990-0252-93:

- Updated format
- Added metric units

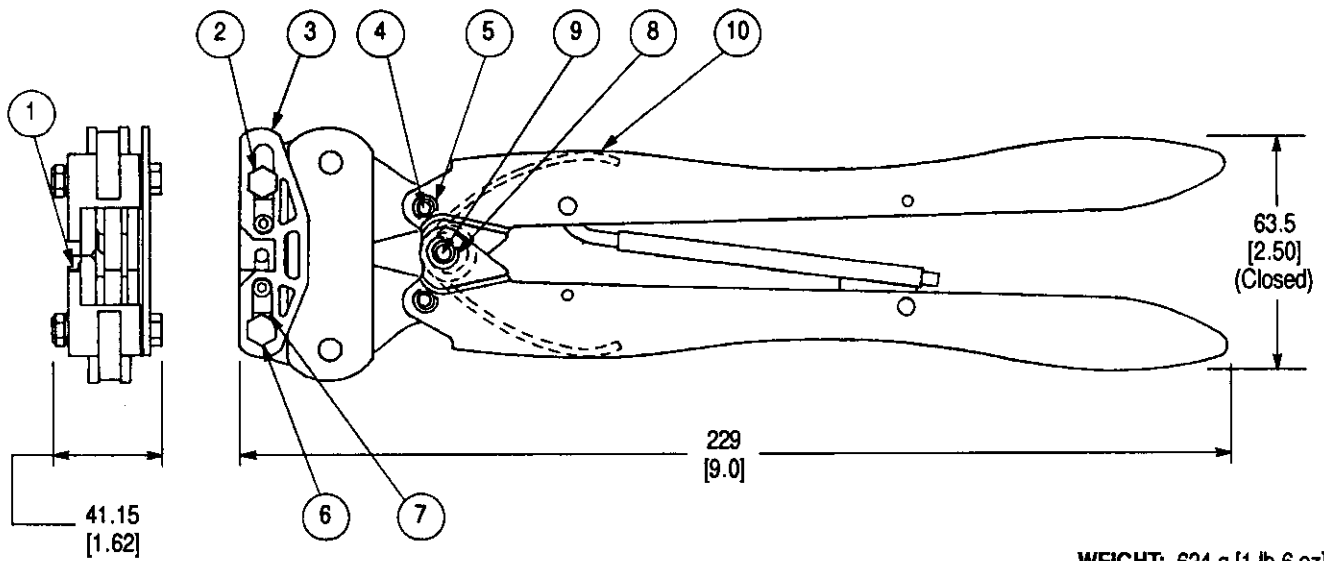

**REPLACEMENT PARTS**

ITEM	PART NUMBER	DESCRIPTION
1	307366-1	GUIDE, Contact Locator
2	307087-5	SCREW, Shoulder
3	307089-1	LOCATOR
4	1-23619-6	PIN, Retaining
5	21045-3	RING, Retaining
6	307087-6	SCREW, Shoulder
7	307339-1	SPACER
8	21045-6	RING, Retaining
9	2-23620-9	PIN, Retaining
10	39364	SPRING

Figure 6

94-83