



Makeblock
Construct Your Dreams

Product Catalogue

INDEX

01~18

Robot Kits

19~29

Extension Kits

30~45

Mechanical Parts

46~55

Electronic Modules

01~18

ROBOT KITS



Airblock

Build it. Code it. Fly it. Airblock is a modular and programmable drone. The transformable blocks enable you to assemble your dream aircraft or hovercraft. Conquer the sky, land and water with Airblock.

Airblock



Highlights

- Take over the sky, land and water: Quickly switch between Drone and Hovercraft forms through simple reassembly, and control Airblock to operate in the sky, or on land and water
- Be creative with it: Create what you want – the blocks can be freely assembled and disassembled. Unleash your imagination to create various interesting projects with everyday items.
- Code to fly: Makeblock APP is available for both iOS and Android. Simply drag and drop different command blocks like forward, pause, and turn, and connect them together to create a series of actions.

Specifications

Product Name	Airblock
Mainboard	Crystal
Microcontroller Chip	SMT32
Motor	6 × Hollow cup motor
Communication Modes	Bluetooth
Softwares (OS Platforms)	Makeblock (Smart Device: iOS / Android)
Power Supplies / Battery	7.4V 700mAh Li-polymer Batter (Included)
Product Dimensions	Aircraft: 230 x 222 x 53 mm (9" x 8.7" x 2") Hovercraft: 335 x 192 x 127 mm (13.2" x 7.5" x 5")
Package Dimensions	380 mmx 297 mmx 135mm (15" x 20" x 6.8")
Actual Weight	Aircraft: 150g (5.29oz) Hovercraft: 195g (6.88oz)

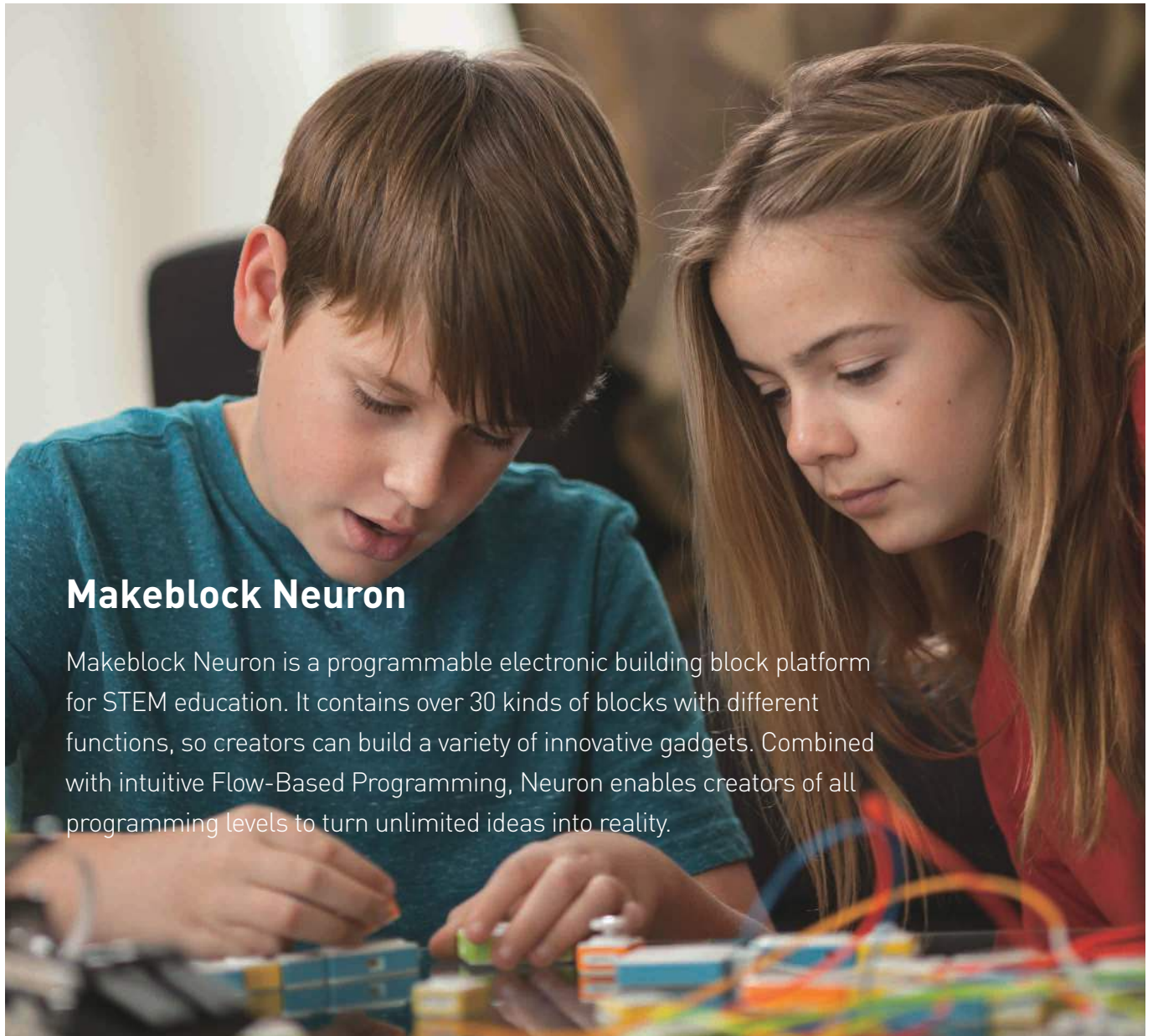

Makeblock Neuron

Makeblock Neuron is a programmable electronic building block platform for STEM education. It contains over 30 kinds of blocks with different functions, so creators can build a variety of innovative gadgets. Combined with intuitive Flow-Based Programming, Neuron enables creators of all programming levels to turn unlimited ideas into reality.

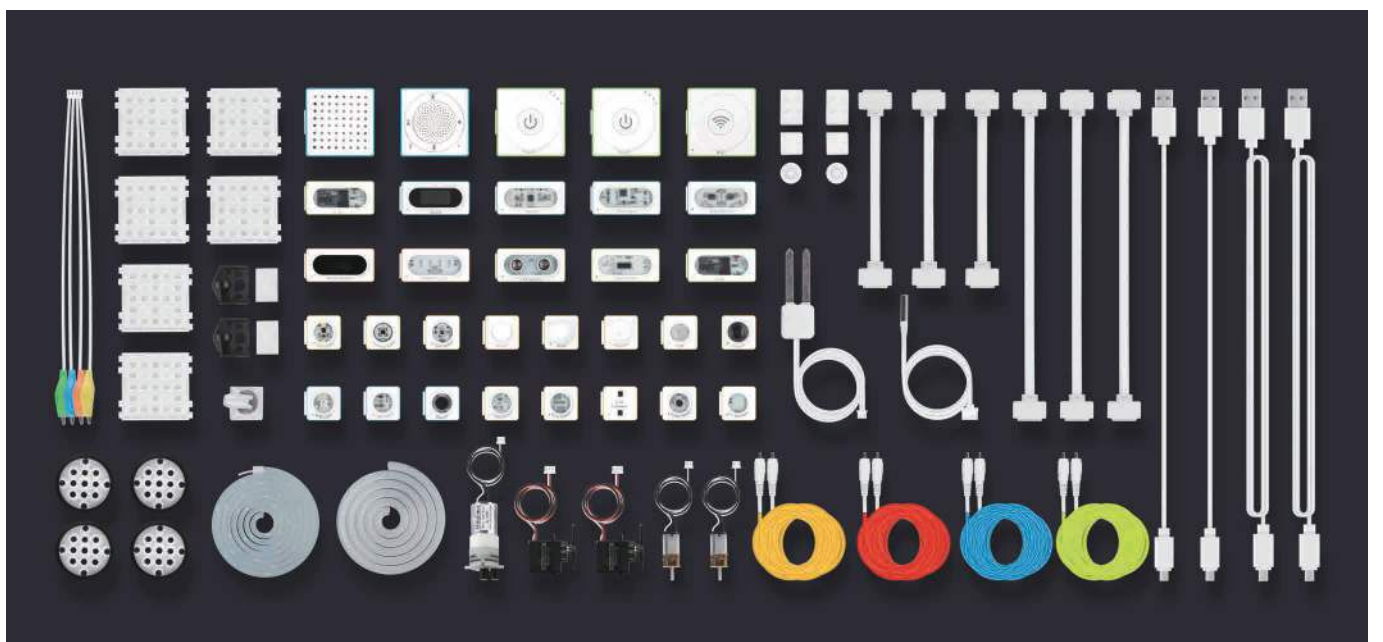

Highlights

- **Simple and Durable:** Each block is simply connected through Pogo Pin, making Neuron more durable.
- **Integrated Solution for STEM Education:** Neuron features specialized blocks with unique functions, intuitive Flow-Based Programming software and rich teaching resources.
- **No Coding Experience Required:** The easy-to-use Flow-Based Programming enables advanced features, like IoT and Microsoft Cognitive Services, with just a few taps.
- **Continuously Updated Teaching Materials:** Build a variety of innovative gadgets by following examples in our guidebooks and updated database.
- **More Blocks, More Creativity:** Create fun gadgets with unique blocks like Voice Recognition, LED Panel, Camera, EL Wire, Joystick, etc.
- **Control Remotely:** Creators can also perform Flow-Based Programming through internet to control Neuron gadgets remotely, e.g. building a gadget at home to take care of their precious during week-long vacations.
- **Limitless Extensions:** Compatible with Makeblock platform and LEGO® blocks - fun is infinite with great ideas.

Specifications

Product Name	Makeblock Neuron 1. Light Wizard Kit 2. Science Lab Kit 3. Explorer Kit 4. All-in-One Kit
Block category	<ul style="list-style-type: none"> • Energy + Communication Blocks: Power, Bluetooth, Wi-Fi, Wireless T, Wireless R • Input Blocks: Line Follower Sensor, Light Sensor, Color Sensor, Ultrasonic Sensor, Gyro Sensor, Temperature Sensor, Sound Sensor, Humiture Sensor, Camera, PIR Sensor, Soil Moisture Sensor • Output Blocks: Dual DC Motor Driver, Dual Servo Driver, RGB LED, LED Panel, LED Strip Driver, Display, Mic&Speaker, Buzzer, EL Wire Driver • Control Blocks: Button, Knob, Joystick, Funny Touch, Voice Recognition
Communication Modes	Bluetooth / Wi-Fi
Softwares (OS platforms)	Neuron (Smart Device: iOS & Android tablet) mBlock (PC: macOS / Windows)
Power Supplies/Battery	3.7V 950mAh Lithium Battery Input: 5V/1A Max Output: 5V/2A Max
Product Dimensions	<ul style="list-style-type: none"> • 24mm x 24mm x 14mm Max: Line Follower, Light Sensor, Color Sensor, Gyro Sensor, Temperature Sensor, Sound Sensor, Humiture Sensor, Camera, PIR Sensor, Button, Knob, Joystick, RGB LED, Soil Moisture Sensor, LED Strip Driver, Buzzer • 24mm x 48mm x 14mm Max: Bluetooth, Voice Recognition, Ultrasonic Sensor, Funny Touch, Display, Dual DC Motor Driver, Dual Servo Driver, Wireless-T, Wireless-R, EL Wire Driver • 48mm x 48mm x 14mm Max: Power, Wi-Fi, LED Panel, Mic & Speaker

mBot STEM Educational Robot Kit

mBot is an ideal entry-level STEM educational robot kit. It provides an entertaining learning experience for beginners by integrating robots and programming. Beginners can learn graphical programming through games and explore more new ways to play with expansion packs and LEGO® blocks.



Expansion Packs



98052
mBot Add-on Pack - Servo Pack



98050
mBot Add-on Pack Six-legged Robot



98056
mBot Add-on Pack - Interactive Light & Sound

mBot STEM Educational Robot Kit

SKU: 90053/90058/90107/90109



Highlights

- No Coding Experience Required: Learning is easy with graphical programming software mBlock and a programming game.
- Limitless Extensions: Equipped with 4 extension interfaces for connecting 40+ electronic modules (7 electronic modules included in the kit), and compatible with Makeblock platform and LEGO® blocks, mBot will bring you endless pleasure.
- Easy to Build: Clear step-by-step instructions, user-friendly design.
- Learning High-Level Languages: From graphical programming to Arduino in C language coding, you master programming from basic to advanced level.
- Continuously Updated Resources: Multi-national teaching materials and online resources updated all the time for endless learning.

Versions

90053 mBot V1.1-Blue (Bluetooth Version)
90058 mBot V1.1-Blue (2.4G Version)

90107 mBot V1.1-Pink (Bluetooth Version)
90109 mBot V1.1-Pink (2.4G)

Specifications

Product Name	mBot STEM Educational Robot Kit
Mainboard	mCore (Arduino Uno compatible)
Microcontroller Chip	ATmega328P
Inputs	Light Sensor, Button, IR Receiver, Me Ultrasonic Sensor, Me Line-follower Sensor
Outputs	Buzzer, RGB LED, IR Transmitter, Motor
Communication Modes	Bluetooth / 2.4GHz Wireless Serial (2.4G Version) / USB
Softwares (OS Platforms)	mBlock (PC: Windows / macOS / Linux) Makeblock (Smart Device: iOS / Android) Arduino (PC: Windows / macOS / Linux) mBlock App (Smart Device: iOS / Android)
Power Supplies / Battery	3.7V Lithium Battery (Not included), or 4 x AA battery (Not included)
Product Dimensions	170mm x 130mm x 90mm (6.69" x 5.12" x 3.54")
Package Dimensions	370mm x 210mm x 50mm (14.57" x 8.26" x 1.97") (Pink version) 215mm x 178mm x 103mm (8.46" x 7.00" x 4.06") (Blue Version)
Actual Weight	500g (17.64oz)

mBot Ranger 3-in-1 Educational Robot Kit

mBot Ranger is a three-in-one STEM educational robot kit with 3 pre-set forms. Building process and learning programming with mBlock are fun and easy. Users can explore more ways to play with expansion packs and LEGO® blocks.



mBot Ranger 3-in-1 Educational Robot Kit

SKU: 90092

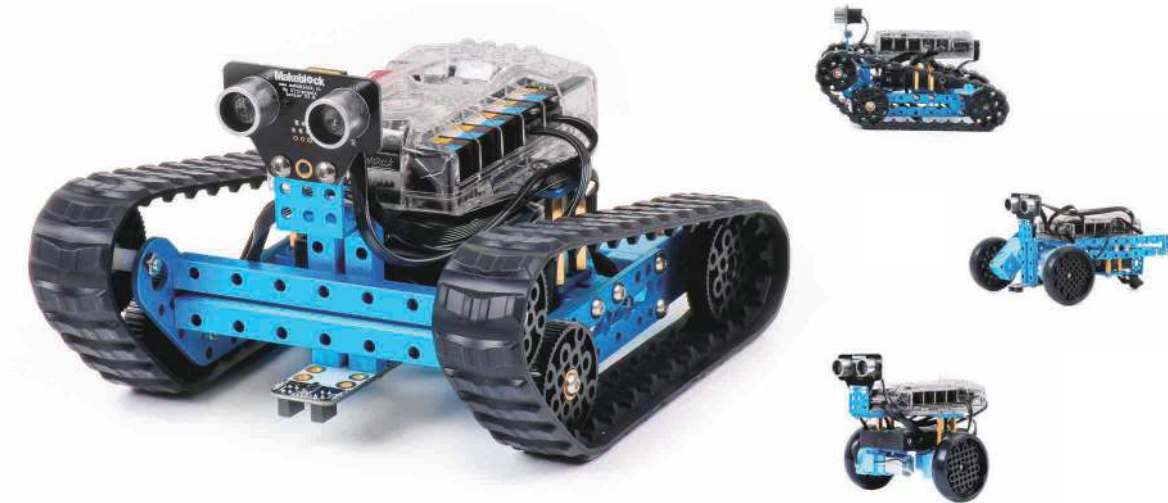

Highlights

- Three-in-One building forms: Land Raider, Nervous Bird and Dashing Raptor
- No Coding Experience Required: Learning is easy with graphical programming software mBlock.
- Limitless Extensions: Equipped with 10 extension interfaces for connecting 40+ electronic modules (12 electronic modules included in the kit), and compatible with Makeblock platform and LEGO® blocks, mBot Ranger will bring you endless pleasure.
- Endless way to Play: Besides various pre-set play modes, simple and easy programming allows you to realize infinite whimsies. The sky's the limit.
- Continuously Updated Resources: Multi-national teaching materials and online resources updated all the time for endless learning.
- Learning High-Level Languages: From graphical programming to Arduino in C language coding, you master programming from basic to advanced level.

Specifications

Product Name	mBot Ranger 3-in-1 Educational Robot Kit
Mainboard	Me Auriga (Arduino Uno compatible)
Microcontroller Chip	ATmega2560-16AU
Mechanical Parts / Electronic Modules	Me Auriga included: Sound Sensor / Light Sensor / RGB LED Ring / Gyroscope Sensor / Buzzer / Ultrasonic Sensor / Line Follower Sensor / 180 Encoder motor
Communication Modes	Bluetooth / USB
Softwares (OS Platforms)	mBlock (PC: Windows / macOS / Linux) Makeblock (Smart Device: iOS / Android) Arduino (PC: Windows / macOS / Linux)
Power Supplies/Battery	6 x AA battery (Not included)
Product Dimensions	175mm x 200mm x 125mm (6.89" x 7.87" x 4.92")
Package Dimensions	270mm x 215mm x 95mm (10.63" x 8.46" x 3.74")
Actual Weight	1600g (56.44oz)

Expansion Pack

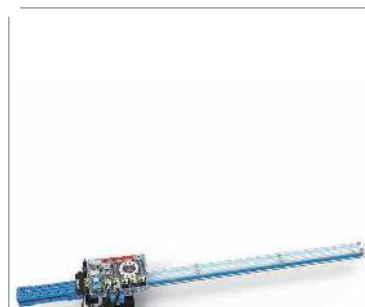

98062
mBot Ranger
Add-On pack - Laser Sword

Ultimate 2.0 - 10-in-1 Robot Kit

Featuring over 160 pieces, and compatible with both Arduino and Raspberry Pi, Ultimate 2.0 allows you to create your unique robot. Whether you are a mechanical or electronics engineer, teacher or student, it lets you learn mechanical structures, electronic modules and programming skills with ease.

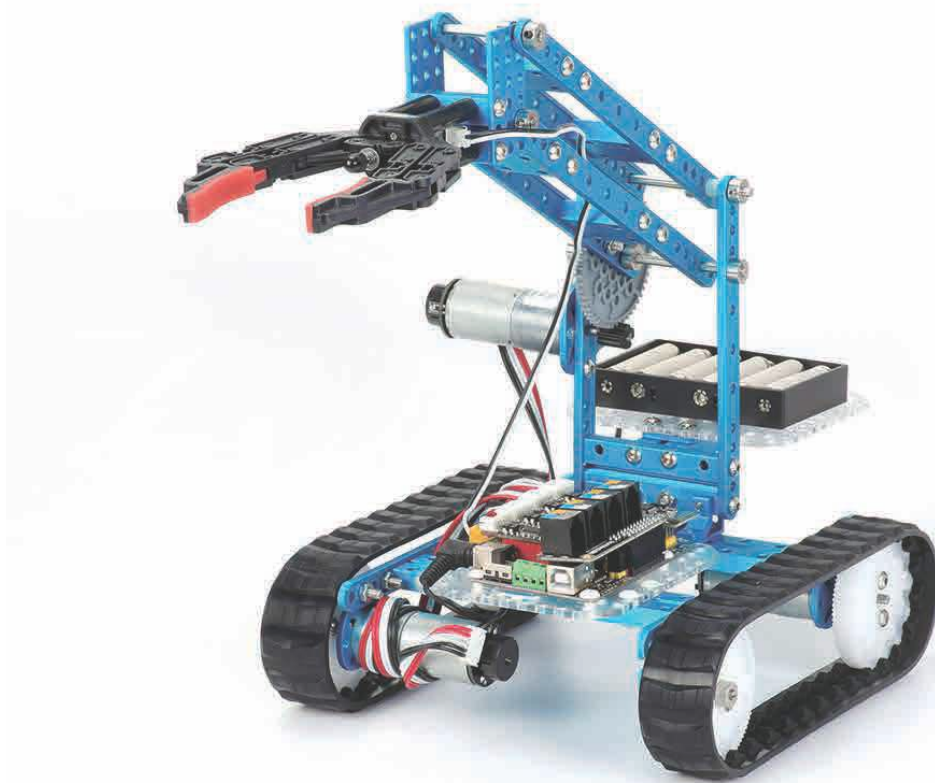

Robotic Arm Tank

Ultimate 2.0 - 10-in-1 Robot Kit

SKU: 90040



Robotic Bartender



Camera Dolly

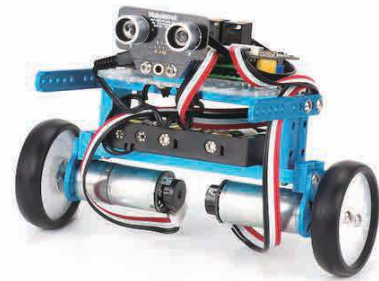

Self-Balancing Robot



3D Capture B



Detecting Robot



3D Capture A



Rolling Tank



Robotic Ant



Catapult Ram

Highlights

- Infinite Extensibility - Satisfy your creative needs with a rich range of standardized parts and electronic modules.
- More Parts, More Creativity - Realize your imagination with over 160+ pieces (80+ types of pieces) including our all new powerful MegaPi mainboard, encoder motors, robotic arm, DC motors, sensors and Blue tooth module. It also comes with a shutter and phone stand for easy photo taking.
- Multiple Control Methods - A specially-designed app enables you to control the robot by simply dragging and dropping command blocks. It supports Arduino IDE programming, graphical programming, Node JS and also Python programming (by combining with RaspberryPi).

Specifications

Product Name	Ultimate 2.0 - 10-in-1 Robot Kit
Mainboard	MegaPi (Arduino compatible)
Microcontroller Chip	ATmegaA2560-16U
Mechanical Parts	Aluminum Extrusion Parts / Plastic Timing Pulleys 90T / Plastic Gears / Tracks and Wheels / Cables / Others Hardware and Accessories
Electronic Modules	MegaPi / MegaPi Shield for RJ25 / Bluetooth Module / Motor Driver / Ultrasonic Sensor / Line Follower Sensor / 3-Axis Accelerometer and Gyro Sensor / RJ25 Adapter / Shutter / Makeblock Gripper / Encoder Motor
Communication Modes	USB / Bluetooth
Softwares (OS Platforms)	mBlock (PC: Windows / macOS / Linux) Makeblock (Smart Device: iOS / Android) Arduino (PC: Windows / macOS / Linux)
Power Supplies / Battery	6 x AA battery [Not included]
Product Dimensions	370mm x 198mm x 267mm (14.57"x7.80"x10.51")
Package Dimensions	508mm x 310mm x 151mm (20" x 12.20" x 5.84")
Actual Weight	3650g (128.75oz)

LaserBot

LaserBot is a desktop laser engraver. Equipped with a 1.6W 445nm high power solid-state laser, and controlled by its software mLaser, LaserBot can easily engrave and cut many things for you, and help you to make innovative gadgets in daily life. For instance, it can make Christmas cards/birthday cards for your family members, or recreate your honeymoon photos with wood for decoration, etc.

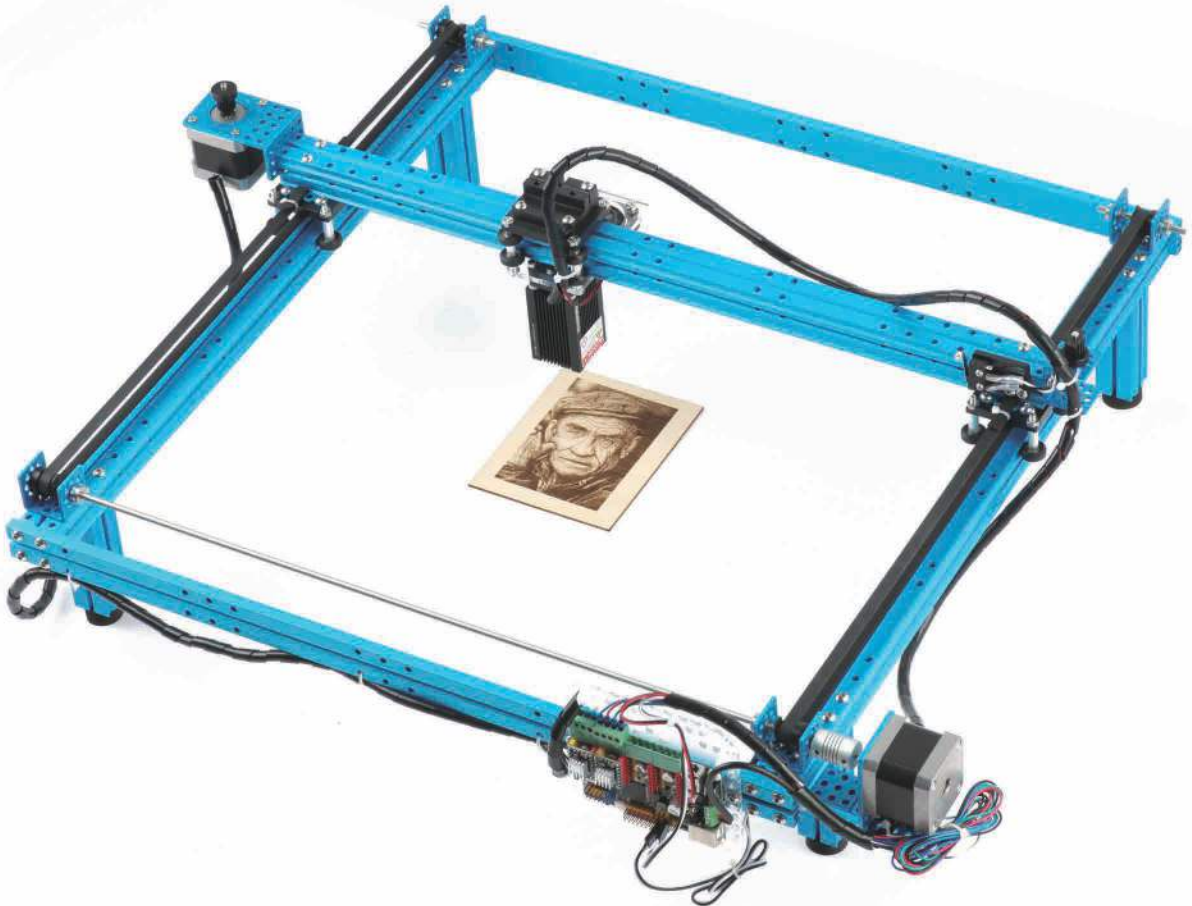

LaserBot

SKU: 90105

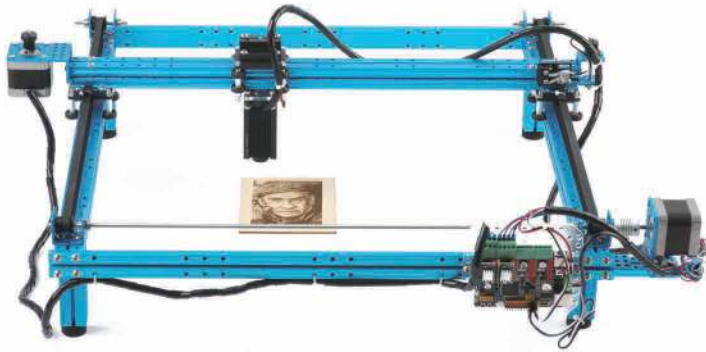

Highlights

- Simple but solid H-shaped structure
- High-precision anodized aluminum alloy
- Arduino compatible
- User friendly software

Specifications

Product Name	LaserBot
Mainboard	MegaPi (Arduino compatible)
Microcontroller Chip	ATmegaA2560-16U
Main Parts / Sensors	1.6W 445nm High-Power Solid State Laser
Mechanical Parts / Electronic Modules	Aluminum Extrusion Parts / Timing Pulley 18T / Linear Motion Slide / MegaPi (Controller) / Stepper Motors / MegaPi Stepper Motor Drivers / Micro Switch 9.Cables / Other Hardware and Accessories
Motor	42 BYG Motor
Communication Modes	USB
Softwares (OS Platforms)	mLaser (PC: Windows / macOS)
Supported File Types	*PNG, *JPG, *BMP, *SVG, *DXF
Accuracy and Precision	0.1mm
Max. working speed	200mm/s
Power Supplies/Battery	100-240V~50/60Hz AC/DC Power adapter, 12V/2.0A
Product Dimensions	535mm × 637mm × 184mm (21.06" × 25.08" × 7.24")
Working area	383mm × 367mm (15.08" × 14.45")
Package Dimensions	562mm × 336mm × 90mm (22.13" × 13.23" × 3.54")
Actual Weight	4475g (157.85oz)

XY Plotter Robot Kit V2.0

XY Plotter Robot Kit is a drawing robot that can move a pen or other instruments to draw digital artwork on flat surface precisely. It can also be developed into a laser engraver by adding our Laser Engraver Upgrade Pack (Sold Separately).

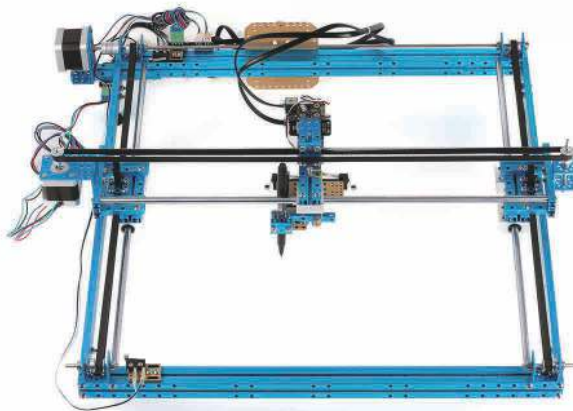
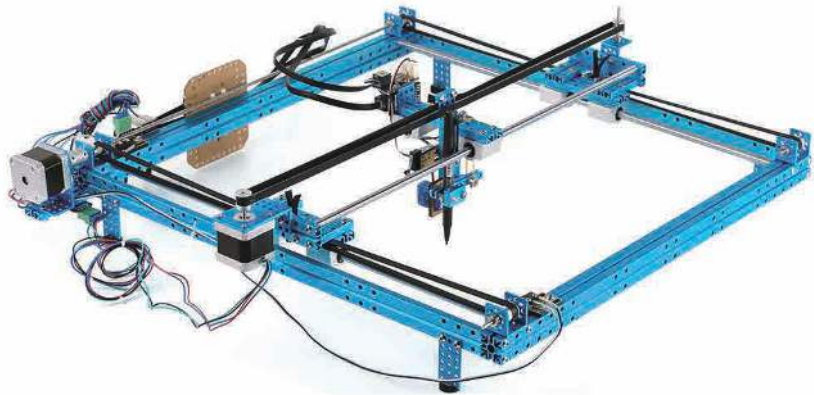

XY Plotter Robot Kit V2.0

SKU : 90014/91018

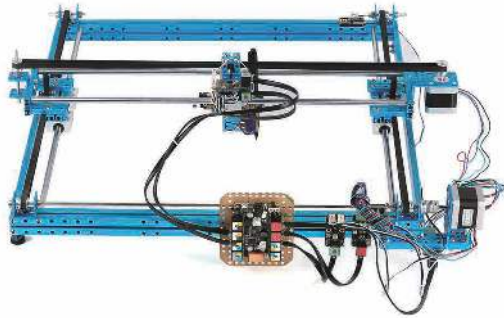

Extension Kit



98004 Laser Engraver Upgrade Pack (500mV) for XY-Plotter Robot Kit V2.0

Highlights

- Super easy-to-use stepper motor driver
- Dual-way transmission mechanism
- Stable working status and high accuracy
- Painting accuracy: 0.1mm

Versions

- 90014** - XY-Plotter Robot Kit V2.0 (With Electronics)
- 91018** - XY-Plotter Robot Kit 2.0 (No Electronics)

Specifications

Product Name	XY Plotter Robot Kit V2.0
Mainboard	Orion (Arduino Uno compatible)
Microcontroller Chip	ATmega2560-16U
Mechanical Parts / Electronic Modulues	Aluminum Extrusion Parts / Timing Pulley 18T / Linear Motion Shaft D8×496mm / Linear Motion Slide Unit 8mm / Makeblock Orion (Controller) / Stepper Motors / Stepper Motor Drivers / 9g Micro Servo Pack / Micro Switch / Cables / Other Hardware and Accessories
Motor	42 BYG Motor
Communication Modes	USB
Softwares (OS Platforms)	mDraw (PC: Windows / macOS) BenBox (PC: Windows)
Supported File Types	*SVG, *BMP, etc.
Accuracy and Precision	0.1mm
Max. working speed	50mm/s
Power Supplies / Battery	100-240 V-50/60Hz AC/DC Power adapter, 12V/3.0A
Working area	310mm × 390mm (12.2" × 15.35")
Product Dimensions	620mm × 620mm × 140mm (24.4" × 24.4" × 5.51")
Package Dimensions	566mm × 333mm × 70mm (22.28" × 13.11" × 2.76")
Actual Weight	4300g (151.68oz)

Starter Robot Kit

Starter robot kit, as its name shows, is a start for your robotics and maker world. With a set of beginner-friendly instructions, it takes you step-by-step on learning robotics, electronics and programming.



Starter Robot Kit

SKU : 90004/90020

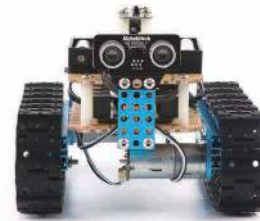
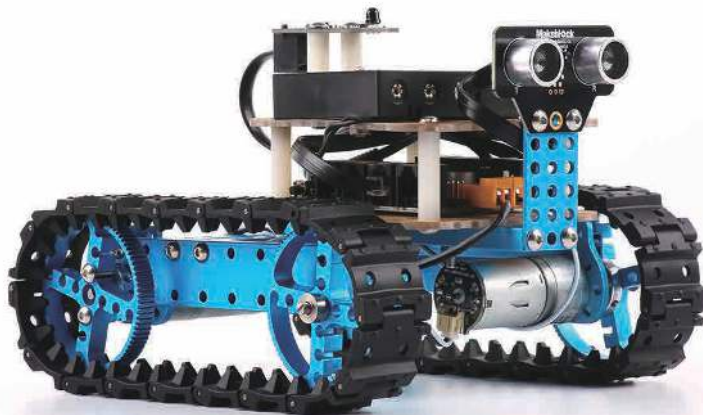

Highlights

- Excellent choice for beginners to learn electronics, graphic programming mBlock, and Arduino programming.
- Build a robot tank or a three-wheel robot car.
- Easy wiring, no soldering required.

Versions

90004 - Starter Robot Kit (IR Version)

90020 - Starter Robot Kit-Blue (Bluetooth Version)

Specifications

Product Name	Starter Robot Kit
Mainboard	Orion (Arduino Uno compatible)
Microcontroller Chip	ATmega328P
Motor	2 x 186 RPM DC Motor
Communication Modes	Bluetooth / IR / 2.4GHz Wireless Serial [2.4G Version] / USB
Softwares (OS Platforms)	mBlock (PC: Windows / macOS / Linux) Makeblock (Smart Device: iOS / Android) Arduino (PC: Windows / macOS / Linux)
Power Supplies / Battery	6 x AA battery (Not included)
Product Dimensions	22mm x 16mm x 130mm [8.66" x 6.3" x 5.12"]
Package Dimensions	257mm x 195mm x 85mm [101.18" x 76.77" x 33.47"]
Actual Weight	1350g [47.62oz]

Extension Kits



98000
Robot Arm Add-on Pack for Starter Robot Kit-BlueElectronic



94010 Add-on Pack for Starter Robot Kit

Inventor Electronic Kit

The Makeblock Inventor electronic kit is a modular electronic platform for quick prototyping. This kit contains 12 sensors and actuators, each with a color-coded connector to simplify wiring. Each module comes with Arduino library for quick programming.



Me PIR Motion Sensor



Me Ultrasonic Sensor



Me Bluetooth Module



Me RGB LED

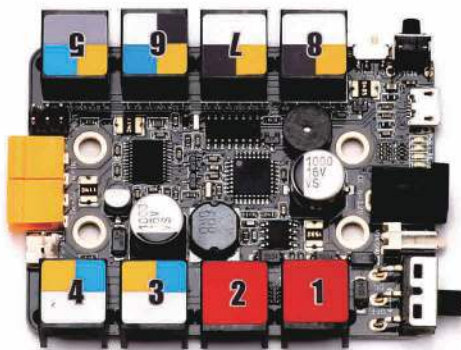

Me Orion



Me Light Sensor



Me RJ25 Adapter



Me Sound Sensor



Me 7-Segment Serial Display - Red



Me Joystick



Me Potentiometer

Inventor Electronic Kit

SKU : 94004

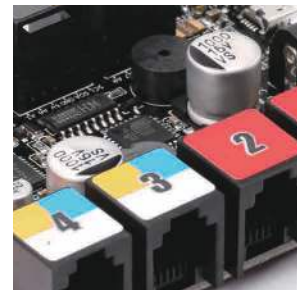

Highlights

- 12 electronic modules included, plus one Makeblock Orion (Arduino-compatible);
- Arduino programming support;
- Graphic programming languages support (mBlock);
- Easy and intuitive wiring with color-coded RJ25 connector;
- Bluetooth module included for connecting with smartphones;
- Comes with smartphone App (Android and iOS available).

Specifications

Product Name	Inventor Electronic Kit
Mainboard	Orion (Arduino Uno compatible)
Microcontroller Chip	ATmega328P
Communication Modes	Bluetooth / USB
Softwares (OS Platforms)	mBlock (PC: Windows / macOS / Linux) Makeblock (Smart Device: iOS / Android) Arduino (PC: Windows / macOS / Linux)
Power Supplies/Battery	DC 6-12V
Package Dimensions	240mm x 170mm x 71mm (9.45" x 6.69" x 2.80")
Actual Weight	470g (16.58oz)

19~29

EXTENSION KITS

Short Beam 0824 Robot Pack - Blue

SKU : 95000

This Beam0824 Pack contains the shorter beams of Beam0824, from 64mm length to 128mm. Total number of beams is 10.

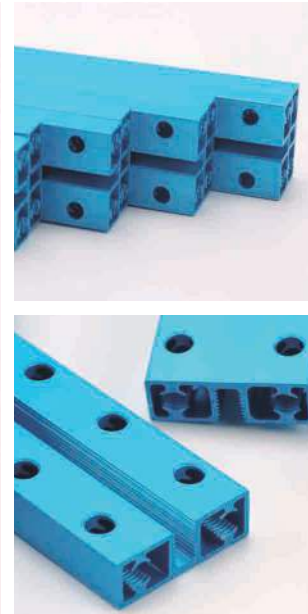
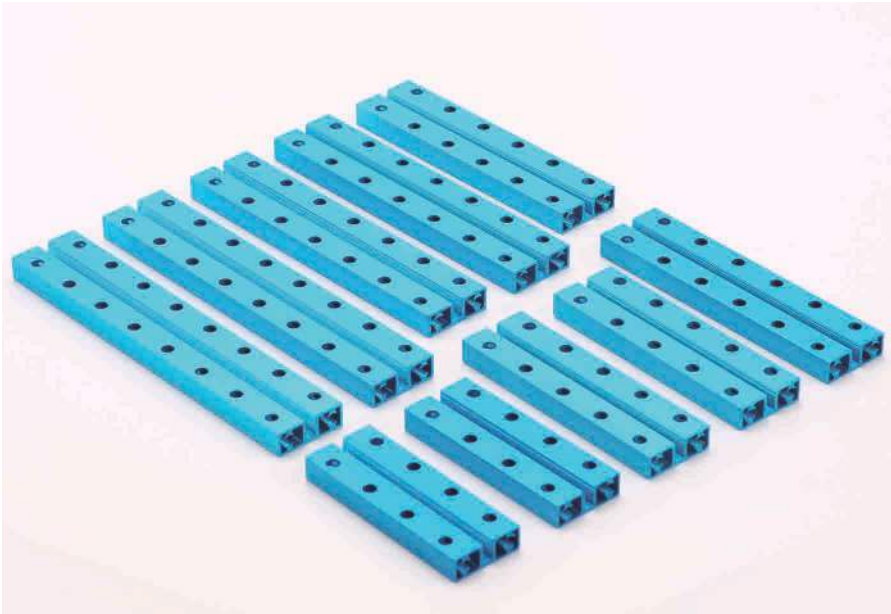

Medium Beam 0824 Robot Pack - Blue

SKU : 95002

This Beam0824 Pack contains the medium length of Beam0824, from 144mm length to 192mm. Total number of beams is 8.

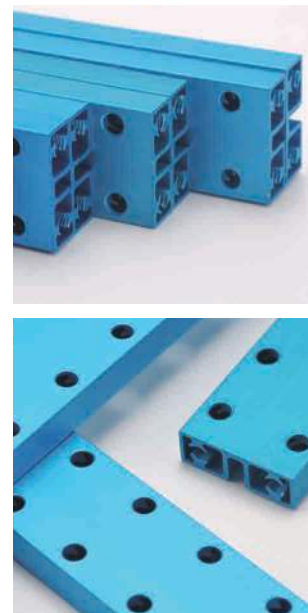
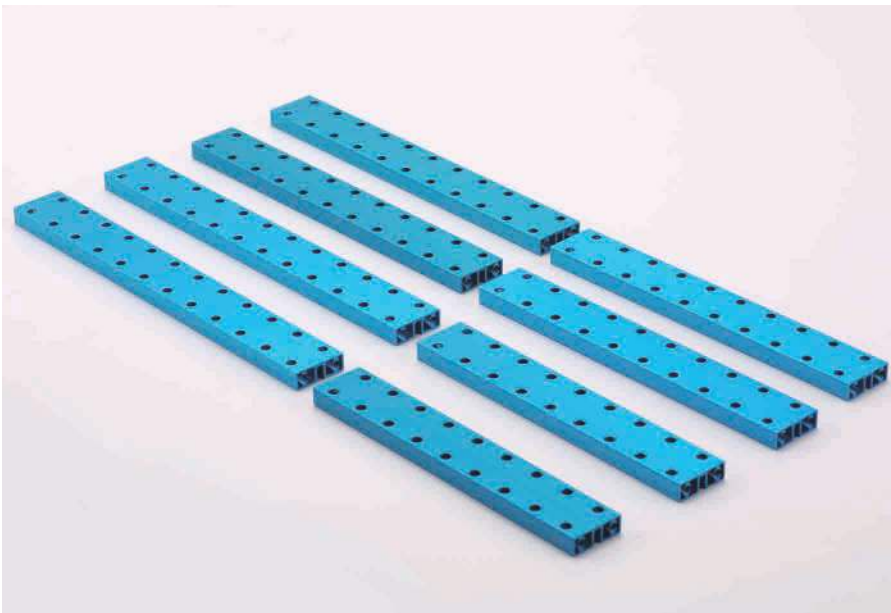

Beam Robot Pack - Blue

SKU : 95004

This beam robot pack contains the most frequently used parts in Makeblock platform, which are compatible with most Makeblock motion and structure components.



Robot Motion Pack - Blue

SKU : 95006

This Kit contains frequently-used parts in building motion mechanisms.

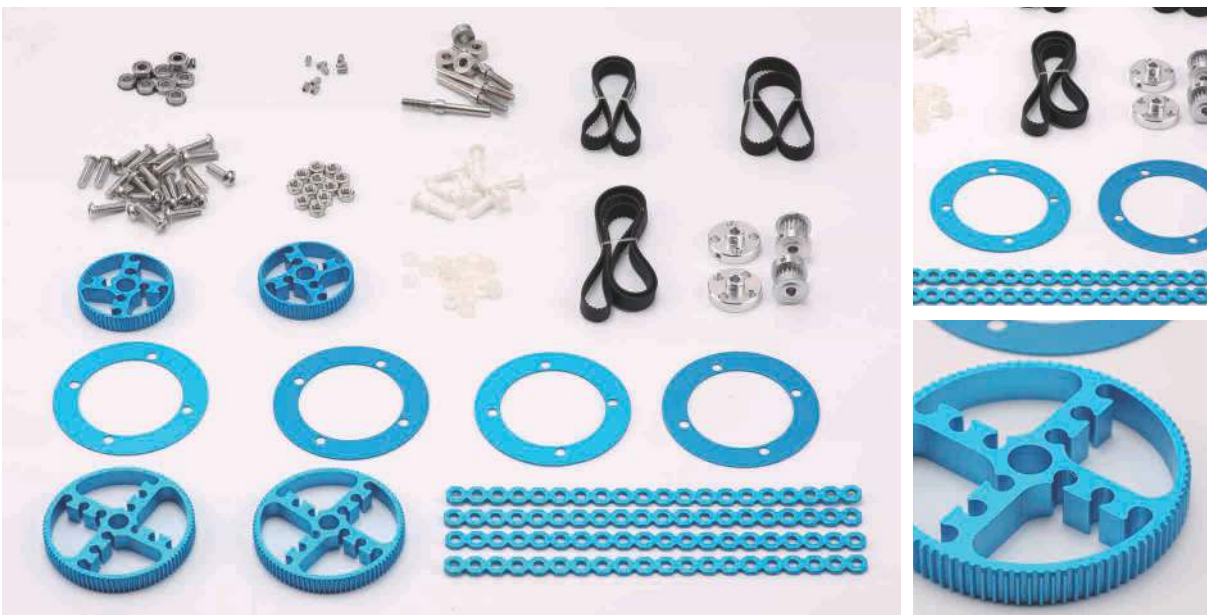

Robot Servo Pack- Blue

SKU : 95008

This Kit contains a Makeblock high torque (15kg.cm) digital servo and 2 servo bracket, with these bracket, it's easy to build a joint for a robot, and also there are a lot of ways to connect the servo with other Makeblock Parts.

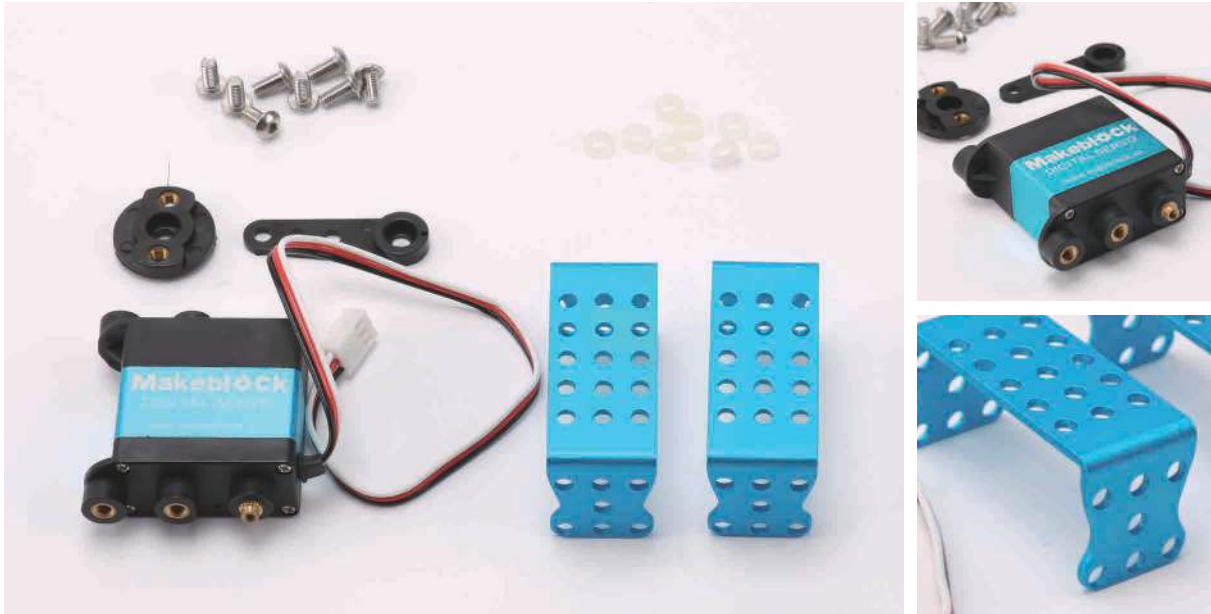

25mm DC Motor Pack-Blue

SKU : 95010

A 25mm diameter DC metal geared motor, together with a motor bracket, a shaft connector and a multipurpose wheel. The multipurpose wheel included can be used as a timing pulley, a wheel hub, or a tank wheel.



37mm Dc Motor Robot Pack-Blue

SKU : 95012

37mm diameter DC metal geared motor, together with a motor bracket, a shaft connector and a multipurpose wheel. The motor bracket included is suitable for 37mm motor and 25mm motor. The multipurpose wheel can be used as a timing pulley, or a wheel hub, a tank wheel.



Thread Drive Pack-Blue

SKU : 95014

This pack included two Fully Threaded Rods, two Linear Motion Shaft, a Universal Joint and a Thread Drive Beam.



Hardware Pack (Nickel-plated Screws)

SKU : 95017

The Makeblock Hardware Robot Pack includes frequently-used hardware in an easily accessible, two-sided component box. The screws in this pack are stainless steel screws that can prevent Oxidation, they have no lubricating on the surface so they look beautiful and clean.



Thread Drive Pack V2.0

SKU : 95022

Thread Drive Pack V2.0 is the updated version of Thread Drive Pack V1.0. It can be used to build thread drive system. In this version, all parts in the demo below are included.



9g Micro Servo Pack

SKU : 95026

Makeblock 9g Micro Servo Pack is a servo pack for beginners who like to make stuff move , it contains a 9g servo, a servo hub, a servo bracket and hardwares. The 9g Micro Servo can rotate approximately 180 degrees, and work like a standard servos .With the servo hub and servo bracket, it is convenient to connect the servo with other parts. A Me RJ25 Adapter also helps you to connect the servo with Me Orion easily.

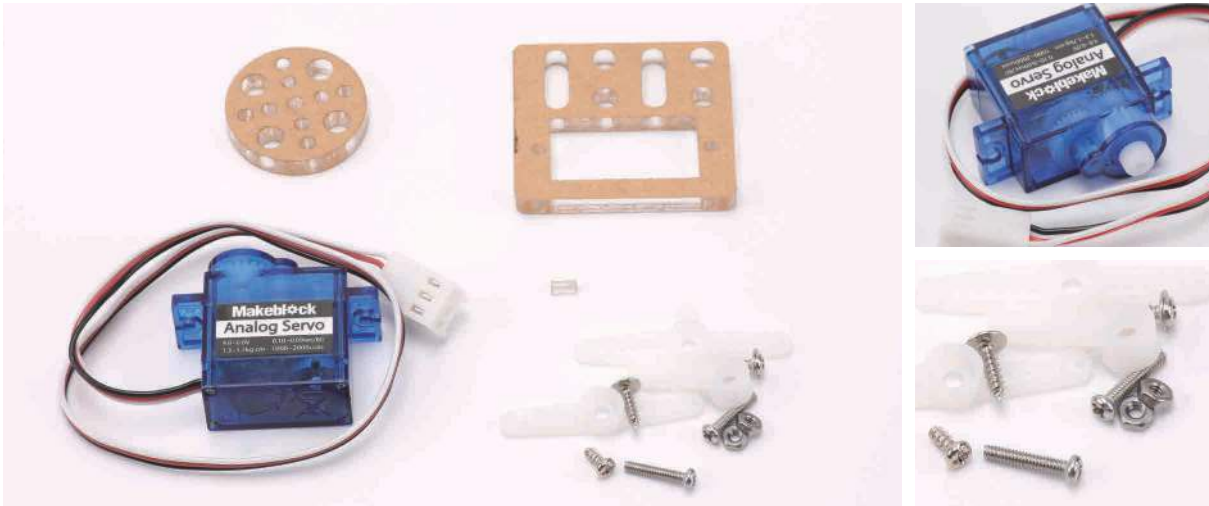

MG995 Standard Servo Pack

SKU : 95029

MG995 Standard Servo Pack contains a MG995 standard servo, a Servo Hub, a servo bracket and some hardwares. MG995 servo is a simple, commonly used standard servo for your mechanical needs. It comes with a standard 3 pin power and control cable for easy using. With the servo hub and servo bracket, it is convenient to connect the servo with other parts. A Me RJ25 Adapter also helps you to connect the servo with Me Orion easily.



Timing Belt Motion Robot Pack-Blue

SKU : 95040

The Makeblock Timing Belt Motion Kit contains frequently-used parts in building motion mechanisms.



Rectilinear Motion Robot Pack

SKU : 95043

The Makeblock Rectilinear Motion Robot Pack contains four kinds of Makeblock components, mainly used to build linear motion mechanisms. For example, attach a nylon pulley to Makeblock beams to give your robot a smooth linear motion.



Bracket Robot Pack-Blue

SKU : 95045

The Makeblock Bracket Robot Pack contains most frequently-used brackets and plates in Makeblock platform, which you can use to make special constructions.

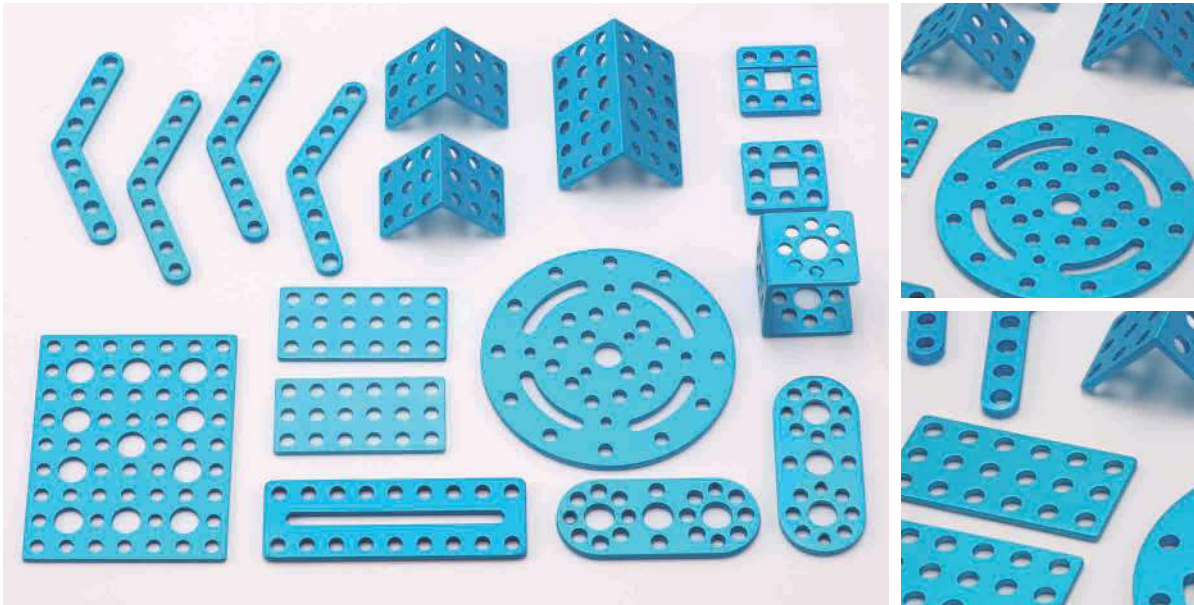

Optical Encoder Motor Pack-25mm

SKU : 95051

Me Encoder Motor Driver can control up to 2 DC Encoder Motor. Precise speed and position of 2 motors can be set and get separately. The motor driver IC is TB6612, same as Me Dual DC Motor Driver. We provide a software for tuning P-I-D parameters of the driver, so that it could work well in different conditions. The reduction-gear ratio of the motor is about 46. You can also edit the reduction-gear ratio in the software.

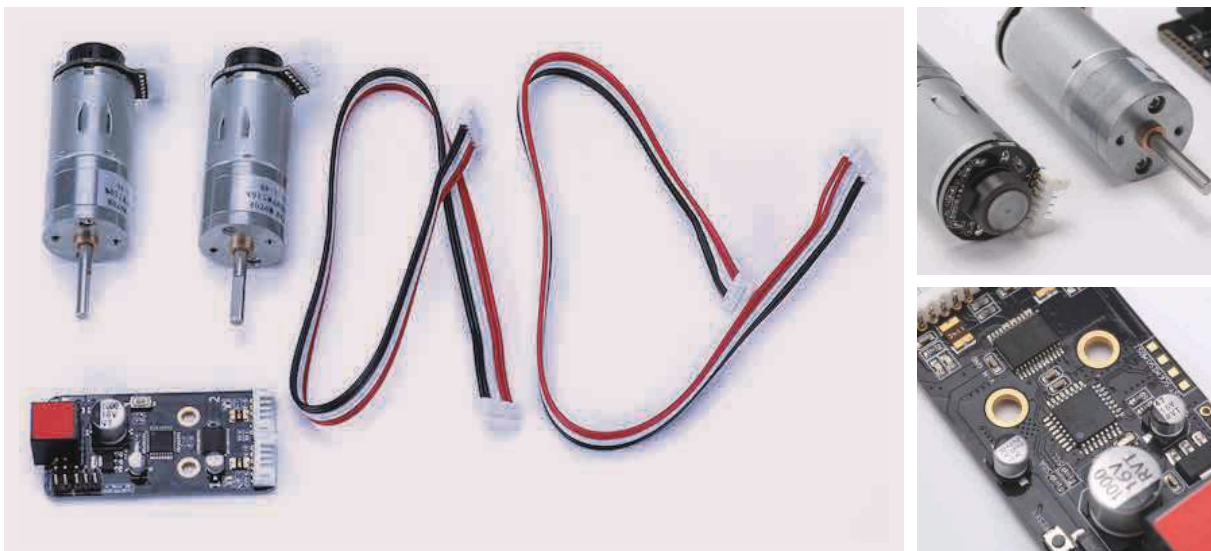

Linear Motion Guide Module Pack - Blue

SKU : 95055

Makeblock Linear Motion Guide Module Pack is a ball linear guide which can be assembled as a linear motion guide robot. The pack can be assembled as a linear motion guide with electronic or without electronic. It is to support and guide the moving parts, meanwhile transform circular motion to linear motion, such as 3D printer, CNC machine. Please refer to below image of 3D printer with 4 Linear Motion Guide Modules.

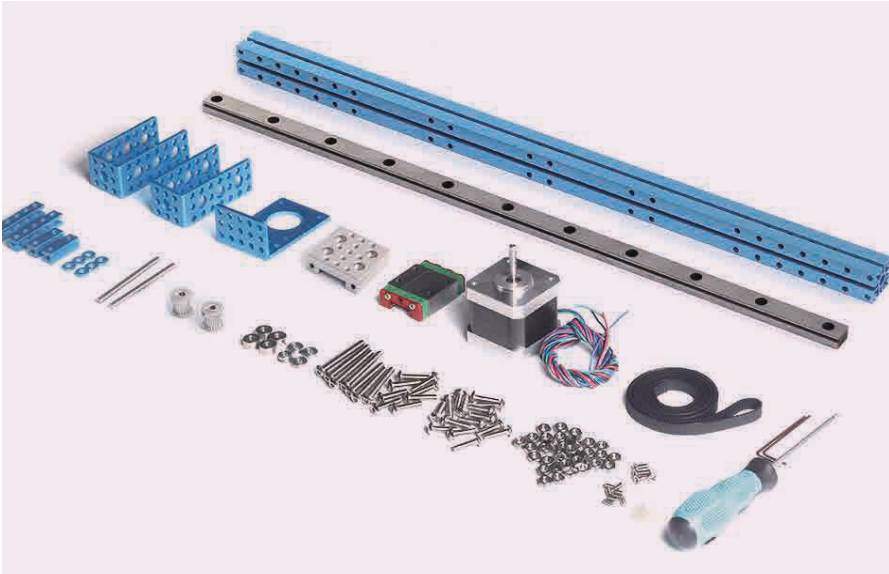

Pneumatic Parts Connector Pack

SKU : 95060

Makeblock Pneumatic Parts Connector Pack includes 3 types of frequently-used pneumatic connectors: 2 x $\phi 4$ T-Coupling, 1 x $\phi 6 - \phi 4$ Reducing T-Coupling, and 1 x $\phi 4$ Cross Four-Way Connector.



Solenoid Valve (3/2way)Pack

SKU : 95061

Makeblock 3/2way solenoid valve is usually used with a single acting pneumatic actuator. Two-position means two controllable positions and three-way means that there are three air channels, one of which is connected with the air supply in general, one of the other two of which is connected with the air inlet of the actuator and the other connected with the air outlet of the actuator. Energize the coil and then the air circuit is connected. Deenergize the coil and then the air circuit is disconnected.



Solenoid Valve (5/2way)Pack

SKU : 95062

The 5/2way solenoid valve is usually used with a double-acting pneumatic actuator. It controls positive or negative direction of movement via powering on/off. The 5/2 way solenoid valve comes with M5 threaded straight hole and works well with $\phi 4$ pneumatic air tube.



100mm Mecanum Wheel Set with 4mm Shaft Connector

SKU : 95064

Mecanum wheels allow your robot to not only travel forward and backward, but also side to side. With 4 mecanum wheels, you can build a carrobot that can move in all direction.



30~45

MECHANICAL
PARTS

Beam0824-016-Blue (4-Pack)

SKU: 60000

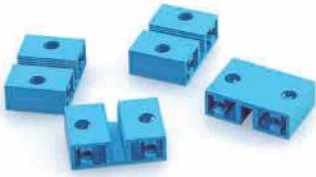

Beam0824-032-Blue (4-Pack)

SKU: 60004

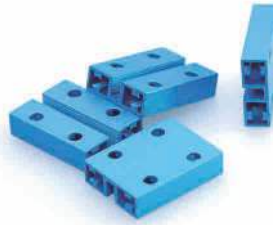

Beam0824-048-Blue (4-Pack)

SKU: 60008



Beam0824-064-Blue (4-Pack)

SKU: 60012



Beam0824-080-Blue (4-Pack)

SKU: 60016



Beam0824-096-Blue (4-Pack)

SKU: 60020

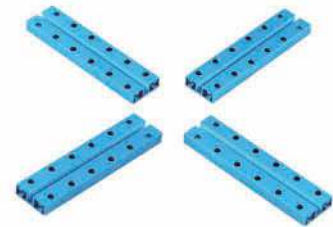

Beam0824-112-Blue (4-Pack)

SKU: 60024



Beam0824-128-Blue (4-Pack)

SKU: 60028

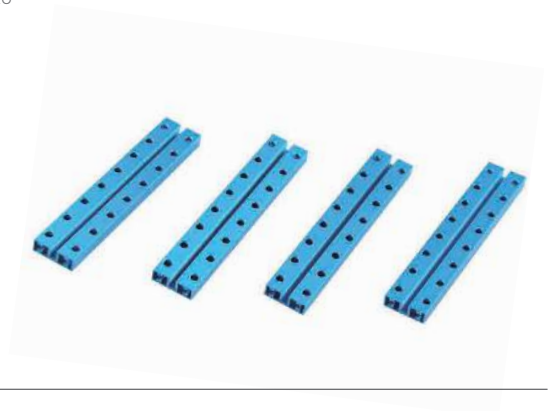

Beam0824-144-Blue (4-Pack)

SKU: 60032

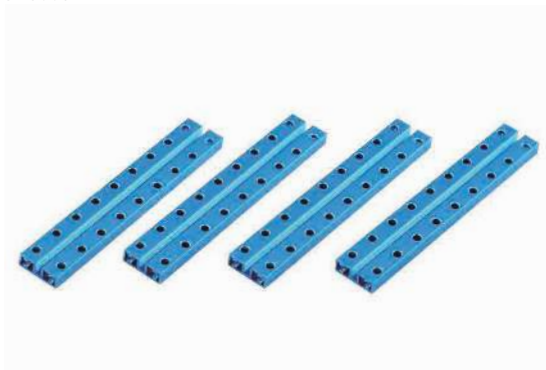

Beam0824-160-Blue (4-Pack)

SKU: 60036

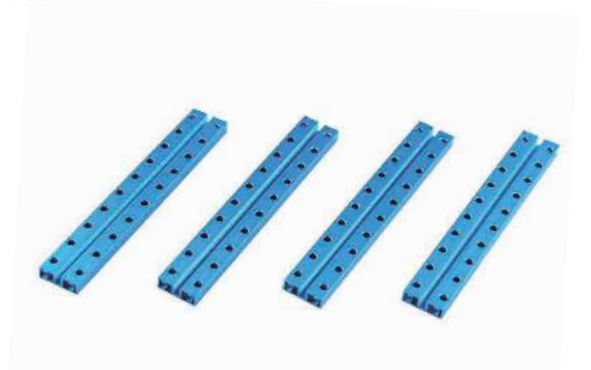

Beam0824-176-Blue(4-Pack)

SKU: 60040

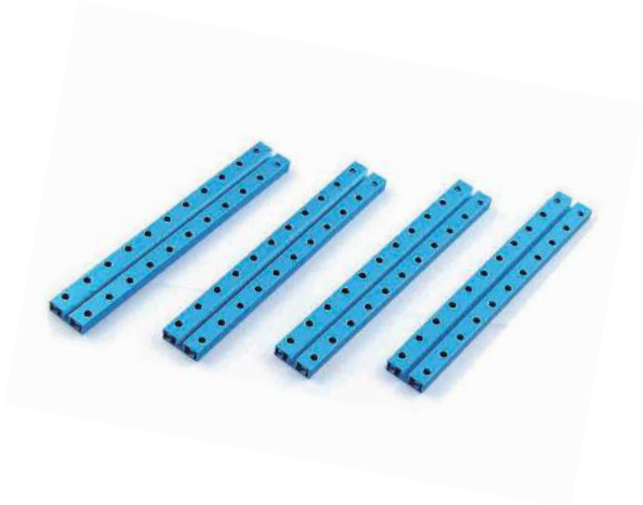

Beam0824-192-Blue(4-Pack)

SKU: 60044



Beam0824-320-Blue(Pair)

SKU: 60076



Beam0824-496-Blue(6-Pack)

SKU: 60120

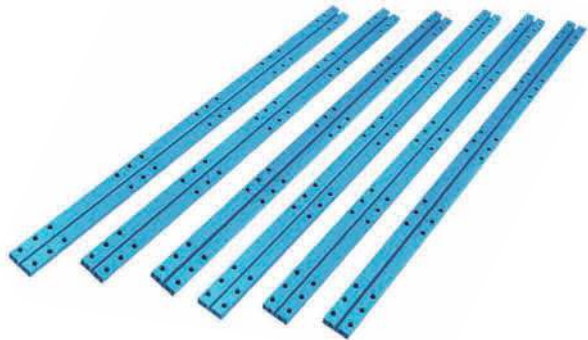

Beam0808-024-Blue (4-Pack)

SKU: 60504



Beam0808-040-A-Blue (4-Pack)

SKU: 60508



Beam0808-040-B-Blue(4-Pack)

SKU: 60510



Beam0808-056-Blue (4-Pack)

SKU: 60512



Beam0808-072-Blue (4-Pack)

SKU: 60516

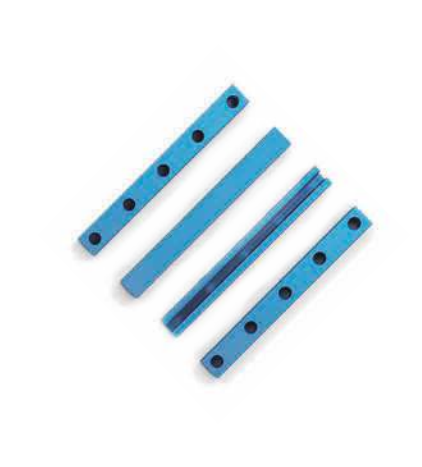

Beam0808-088-Blue (4-Pack)

SKU: 60520



Beam0808-120-Blue (4-Pack)

SKU: 60528



Beam0808-136-Blue (4-Pack)

SKU: 60532



Beam0808-152-Blue (4-Pack)

SKU: 60536

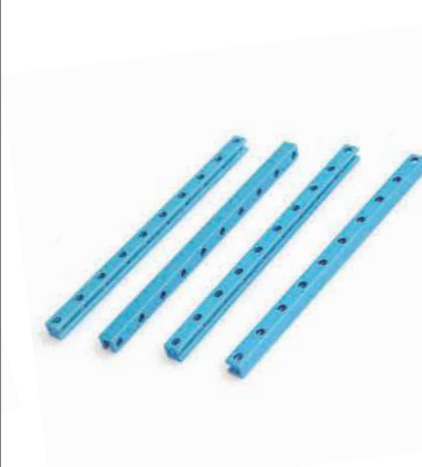

Beam0808-168-Blue (4-Pack)

SKU: 60540

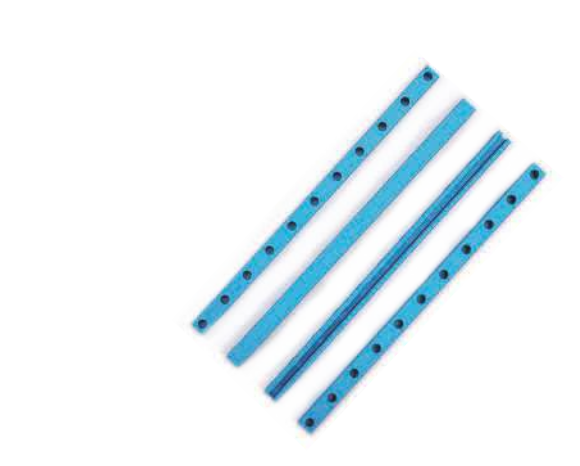

Beam0808-184-Blue(4-Pack)

SKU: 60544

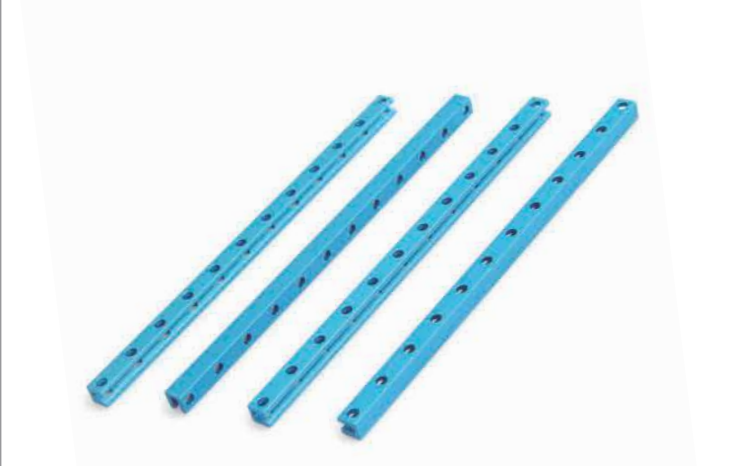

Beam0808-312-Blue (Pair)

SKU: 60576



Beam0808-504-Blue (Pair)

SKU: 60624



Beam2424-312-Blue (Single Pack)

SKU: 60872



Beam2424-504-Blue (Single Pack)

SKU: 60920

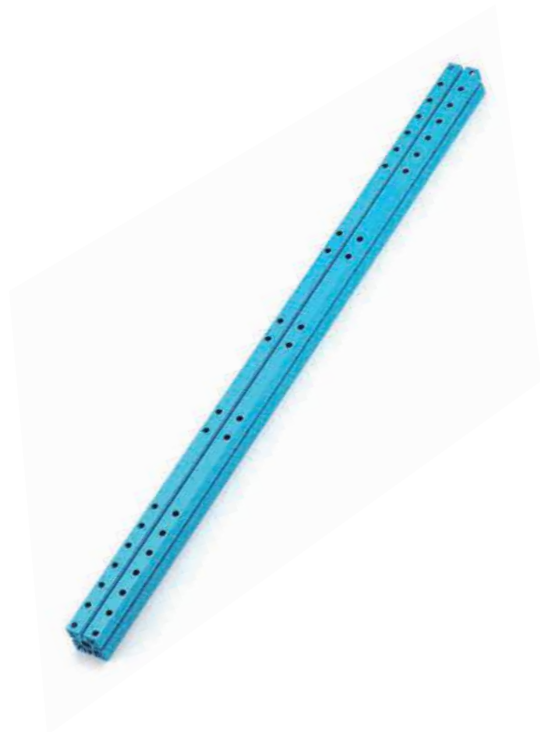

Thread Drive Beam M4*40 (Pair)

SKU: 61110



DC Motor-25 9V/185RPM

SKU: 80038



DC Motor-25 9V/30RPM

SKU: 80044



DC Motor-25 9V/86RPM

SKU: 80041



DC Motor-25 9V/325PM

SKU: 80035



DC Motor-25 9V/700PM

SKU: 80032



DC Encoder Motor-25 6V/185RPM

SKU: 80086



DC Motor-37 12V/50RPM

SKU: 80402



DC Motor-37 12V/200RPM

SKU: 80417



**36 DC Geared Motor
12V/240RPM**

SKU: 80501



MG995 Standard Servo

SKU: 80801



MEDS15 Servo Motor

SKU: 80802



42BYG Stepper Motor

SKU: 81042



57BYG Stepper Motor

SKU: 81057

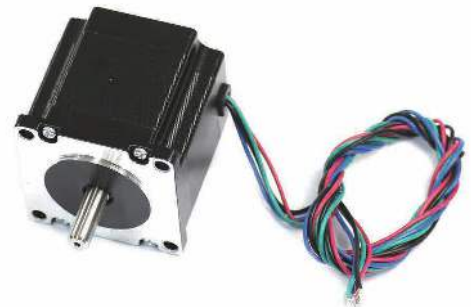

820 Coreless Motor (Pair)

SKU: 81300



555 High-Speed CNC motor 24V/10000RPM

SKU: 81310



DC Motor-25 Bracket B-Blue (Pair)

SKU: 61802



DC Motor-37 Bracket-Blue (Pair)

SKU: 61804



42BYG Stepper Motor Bracket B-Blue

SKU: 62003



Bracket P1-Blue (Pair)

SKU: 62400

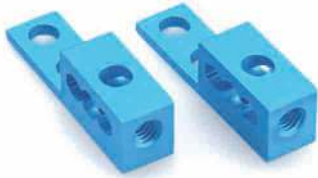

MEDS15 Servo Motor Bracket-Blue(Pair)

SKU: 62208



Bracket P3-Blue(Pair)

SKU: 62404

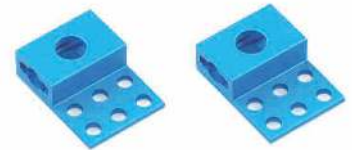

57BYG Stepper Motor Bracket pack-Black

SKU: 62040



Servo Bracket A

SKU: 62216



Linear Motion Block Bracket A

SKU: 62412



3D Printer nozzle Bracket A

SKU: 62414



Plate 3*6-Blue(4-Pack)

SKU: 61200

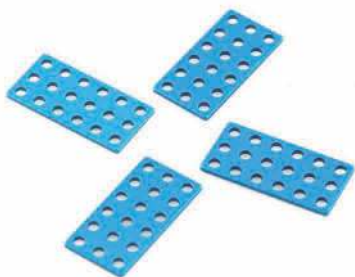

Plate 7*9 B-Blue (Pair)

SKU: 61210

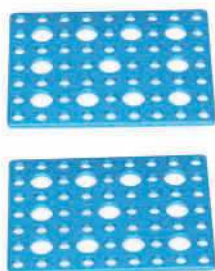

Plate I1-Blue (Pair)

SKU: 61216



Plate O1-Blue (Pair)

SKU: 61220



Disc D72-Blue (Pair)

SKU: 61354



Plate 45°-Blue (Pair)

SKU: 61400

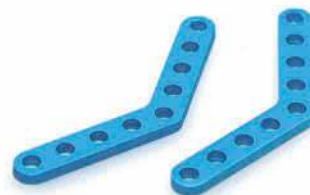

Plate A-Blue(Pair)

SKU: 61404



Triangle Plate 6*8 (Pair)

SKU: 61408

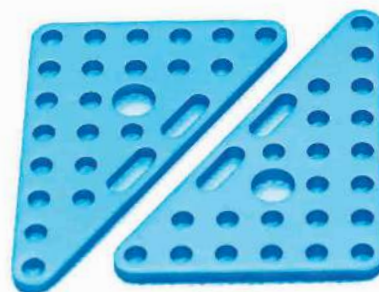

Bracket 3*3-Blue (4-Pack)

SKU: 61500

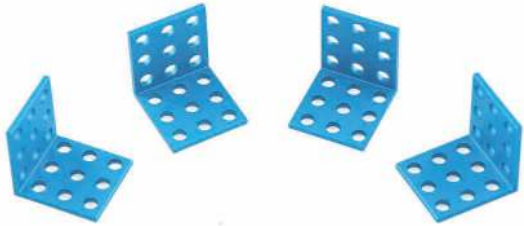

Bracket 3*6-Blue(4-Pack)

SKU: 61508

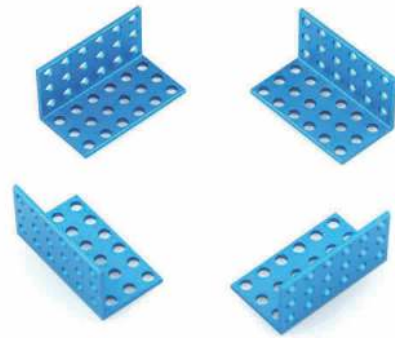

Bracket L1-Blue (Pair)

SKU: 61512



Bracket U1-Blue (Pair)

SKU: 61516



U Bracket B-Blue

SKU: 61520

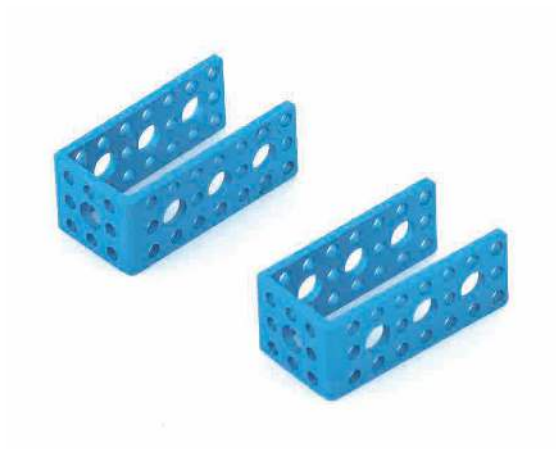

MG995 Servo Hub

SKU: 69001



HE* Allen Key 1.5mm(Pair)

SKU: 70002



**Headless Set Screw
M3*5(50-Pack)**

SKU: 70512



**Socket Cap Screw
M4*8-Button Head (50-Pack)**

SKU: 70552



**Socket Cap Screw
M4*14-Button Head (50-Pack)**

SKU: 70555



**Socket Cap Screw
M4*16-Button Head (50-Pack)**

SKU: 70558



**Socket Cap Screw
M4*22-Button Head (50-Pack)**

SKU: 70561



**Socket Cap Screw
M4*30-Button Head (25-Pack)**

SKU: 70564



**Socket Cap Screw
M4*35-Button Head (25-Pack)**

SKU: 70567



Nut 4mm(50-Pack)

SKU: 71002



**Nylon Lock Nut 4mm
(50-pack)**

SKU: 71004



**Plastic Rivet R4060
(50-Pack)**

SKU: 71543



**Socket Cap Screw
M4*40-Button Head (25-Pack)**

SKU: 70570



Brass Stud M4*8+6(10-Pack)

SKU: 71942



Brass Stud M4*16(10-Pack)

SKU: 71944



Cross & 2.5mm HE* Screwdriver

SKU: 70015



DC Frame Type Solenoid HCNE1-0530

SKU: 81500



Plastic Spacer 4*8*1(100-Pack)

SKU: 72341



Plastic Spacer 4*7*2(100-Pack)

SKU: 72342



Plastic Rivet R4120(50-Pack)

SKU: 71546



Timing Pulley 18T(Pair)

SKU: 83002



Timing Pulley 32T(Pair)

SKU: 83005



Timing Pulley 62T-Blue (4-Pack)

SKU: 83008



Timing Pulley 90T-Blue (4-Pack)

SKU: 83016



Timing Pulley Slice 90T B-Blue(4-Pack)

SKU: 83022

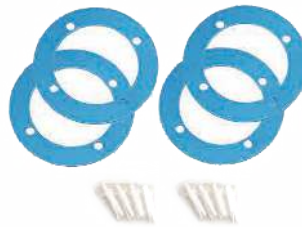

Timing Belt 123T(Pair)

SKU: 83040



Timing Belt 216T(Pair)

SKU: 83042



Timing Belt 378T(Pair)

SKU: 83044

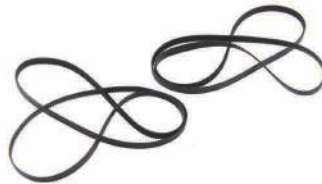

Timing Belt (2m), Open-end

SKU: 83046



Timing Belt (5m), Open-end

SKU: 83048



Belt Connector Blue (Pair)

SKU: 83090



Belt Connector B

SKU: 83092



Gear 16T

SKU: 83410



Gear 48T

SKU: 83420



Gear 80T

SKU: 83430



**Cuttible Linkage Blue
(10-Pack)**

SKU:84420

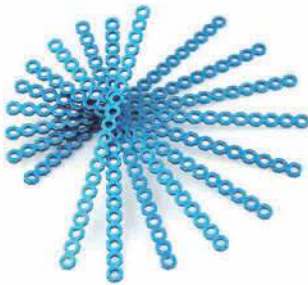

**Thread Drive Beam
M4*80-Blue (Pair)**

SKU: 84004



**Fully Threaded Rod
M4*288mm (Pair)**

SKU: 84044



**Threaded Shaft
4*39mm(4-Pack)**

SKU:85008



**Linear Motion Slide
Unit 8mm (Pair)**

SKU: 86050



**Linear Motion
Shaft D8*312mm-H**

SKU: 85421



D Shaft 4*56mm (4-Pack)

SKU: 85001



D Shaft 4*128mm

SKU:85003



D Shaft 4*160mm (4-Pack)

SKU: 85004



Linear Motion Shaft D4*240mm

SKU: 85407



Linear Motion Shaft 4*288mm (4-Pack)

SKU: 85020



Shaft D8*96mm

SKU: 85403



Shaft D8*96mm-H

SKU: 85404



Shaft D8*128mm

SKU:85405



Shaft D8*128mm-H

SKU: 85406



Linear Motion Shaft D8*312mm-H

SKU: 85412



Linear Motion Shaft D8*272mm-H

SKU: 85408



Linear Motion Shaft D8*400mm-H

SKU: 85416



Universal Joint 4*4mm

SKU: 84700



Flexible coupling 4*4mm

SKU:84720



Shaft Connector 4mm(Pair)

SKU: 84740



Shaft Collar 4mm(10-Pack)

SKU:84750



Shaft Collar 8mm

SKU: 84754



Shaft Clamping Hub 8mm

SKU: 84780



Slider256Blue(4-Pack)

SKU: 86004



Slider496Blue(4-Pack)

SKU:86008

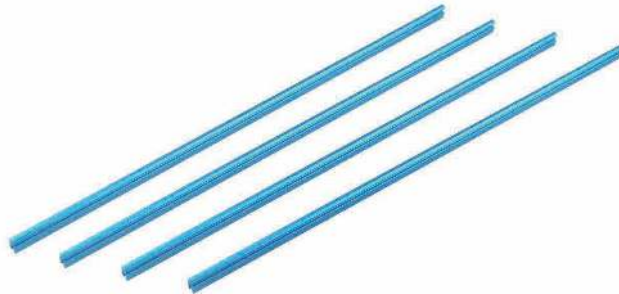

Linear Motion Guide Rail 496mm (Single Pack)

SKU: 86020



Linear Motion Block (Single Pack)

SKU: 86060



Robot Gripper-Black

SKU: 86502



Caster Wheel(Pair)

SKU: 87000



Tyre 68.5*22mm(4-Pack)

SKU:87030



Track With Track A*le(40-Pack)

SKU: 87050



Nylon Pulley with bearing (4-Pack)

SKU:87300



Female Rod End Bearing 4mm (3-Pack)

SKU: 87301



Male Rod End Bearing 4mm (3-Pack)

SKU: 87302



8mm Bearing Bracket A

SKU: 87303



Flange Bearing 4*8*3mm (10-Pack)

SKU:87330



V-slot Bearing(4-Pack)

SKU: 87370



Electric Grinder cut sheet

SKU: 89001



High-Speed Steel Saw

SKU: 89002



46~55

ELECTRONIC
MODULES

MegaPi

SKU : 10050

The Most Powerful Main Control Board In Motion Control.



- MegaPi is mainboard based on the ATmega2560. And it can be programmed with the Arduino Software (IDE). MegaPi comes with a 16 MHz crystal oscillator and a USB connection to download programs.
- It has two high-power output interfaces which have a maximum output current of 10A. MegaPi is the recommended board for various application scenes, such as 3D printer, CNC and robotic projects. Moreover, MegaPi can also be applied in education, game and entertainment field.
- MegaPi has the same size as Raspberry Pi. With the support of serial ports and programs, Raspberry Pi then will be able to drive motors and sensors.

Mainboard structure

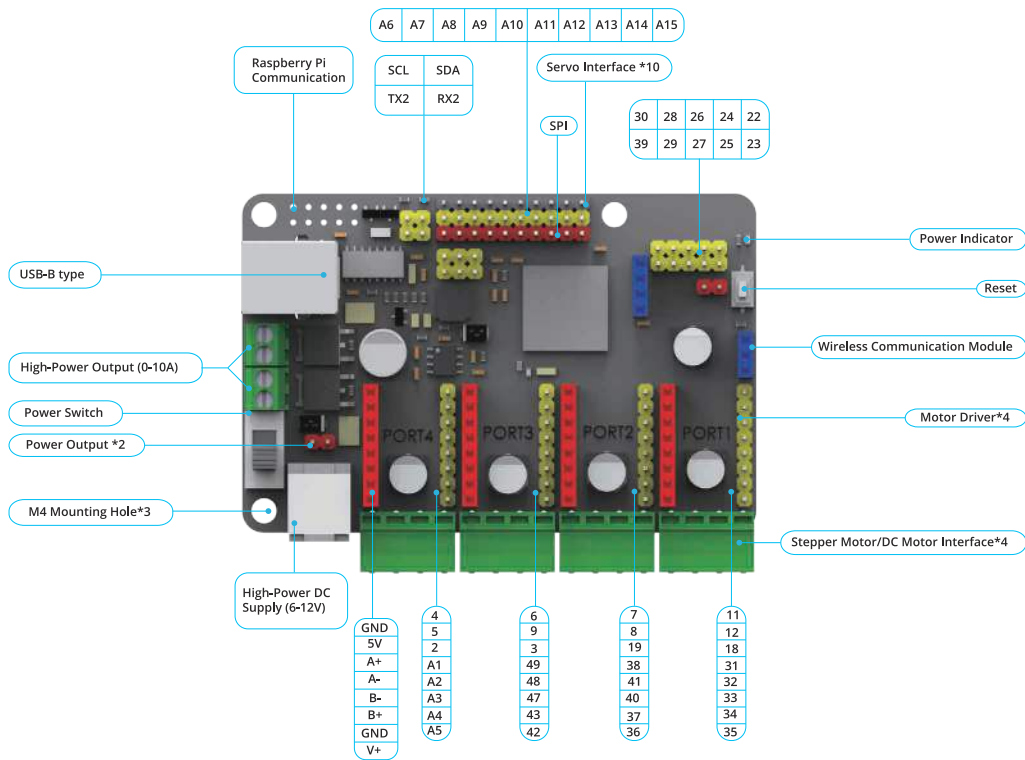

The various colors on MegaPi represents s

- Red pin--power output/motor output
- Blue pin--wireless communication interface
- Green pin--motor/power output
- Yellow pin--I/O pin
- Black pin--power GND

Technical Specifications

Microcontroller chip	ATMEGA2560-16AU
Input Voltage	DC 6V-12V
Operating Voltage	DC 5V
I/O Pins	43
Serial Ports	3
I2C Interface	1
SPI Interface	1
Analog Input Pins	15
DC Current per I/O Pin	20mA
Flash Memory	256KB
SRAM	8KB
EEPROM	4KB
Clock Speed	16 MHz
Dimension	85*63mm

Features

- Four motor driver interfaces for adding encoder motor driver and stepper motor driver, and thus to drive DC motors, encoder motors and stepper motors;
- One wireless communication interface for adding Bluetooth module or 2.4G module;
- Ten servo interfaces which enable the board to drive up to 10 servos at the same time;
- Two high-power MOS driver interface which is able to drive devices with a maximum current of 10A. Maximum output: DC 5V 3A;
- One Raspberry Pi switch interface (requires manual soldering) to realize 5V to 3.3V serial communication;
- Three M4 mounting holes which allow the board to be connected with Raspberry Pi; Slide switch for controlling the power supply;
- B-type USB interface for downloading programs and communications. It uses the CH340G USB to serial chip which can realize communication between the computer and MegaPi easily and stably;
- High-power DC input interface with an over-current protection of 2A and anti-reverse measurement;
- One reset key, one power indicator (red) and one I/O indicator (blue).

Me Orion

SKU: 10021



Me UNO Shield

SKU: 10031

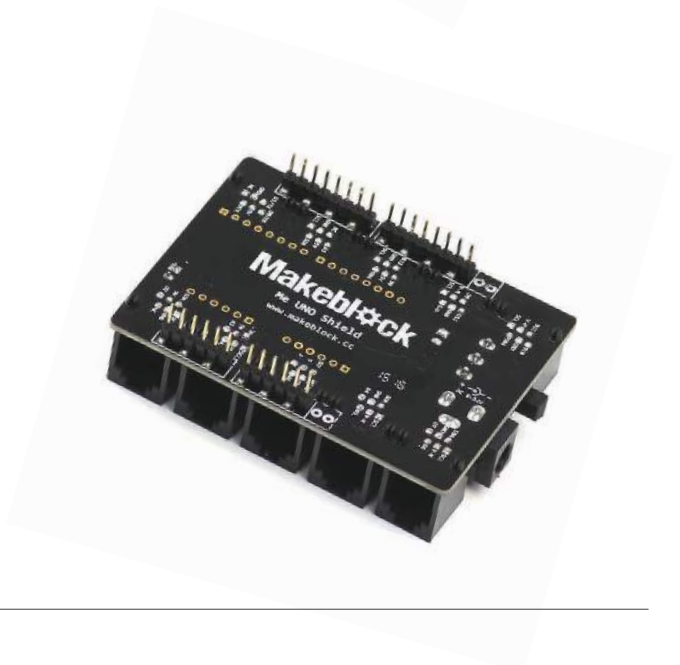

Me Shield for Raspberry Pi

SKU: 10504



Me Ultrasonic Sensor

SKU: 11001



Me Line Follower

SKU: 11005



Me Light Sensor

SKU: 11007



Me Sound Sensor

SKU: 11008



Me PIR Motion Sensor

SKU: 11010



Me 3-Axis Accelerometer and Gyro Sensor

SKU: 11012



Me Temperature Sensor-Waterproof

SKU: 11014



Me Touch Sensor

SKU: 11020



Me Compass

SKU: 11024



Me 2H Microstep Driver

SKU: 12008



Me Stepper Motor Driver

SKU: 12009



Me Dual DC Motor Driver

SKU: 12015

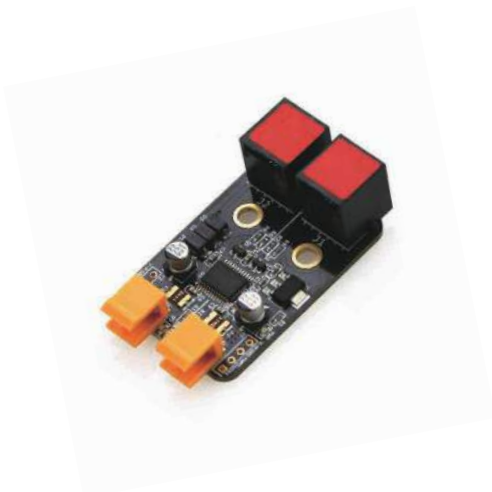

Me Encoder Motor Driver

SKU: 12020



Me 130 DC Motor Pack

SKU: 12802

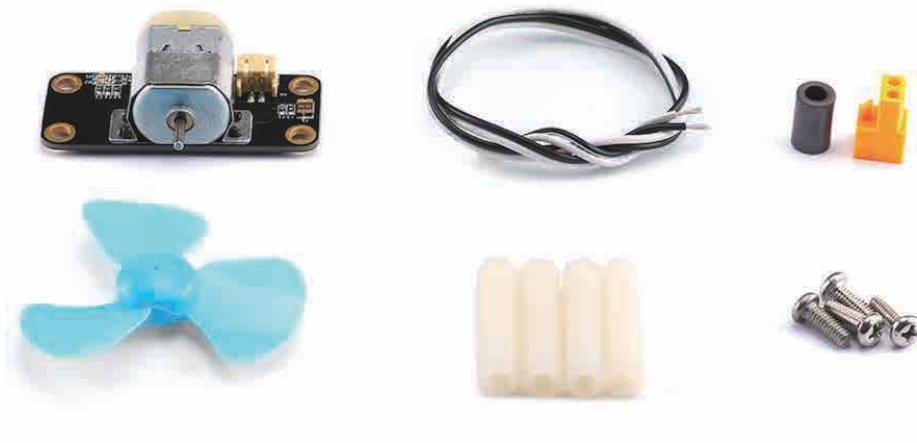

Me Bluetooth Module (Dual Mode)

SKU: 13002



Me Infrared Receiver Decode

SKU: 13005



Me USB Host

SKU: 13010



Me Wifi Module

SKU: 13020



2.4G Wireless Serial for mBot

SKU: 13030



Bluetooth Module for mBot

SKU: 13035



Me RGB LED

SKU: 13400



Me 7-segment serial display-Red

SKU: 13402



LED RGB Strip-Addressable, Sealed(0.5M)

SKU: 13404



LED RGB Strip-Addressable, Sealed(1M)

SKU: 13406



Me TFT LCD Screen - 2.2 Inch

SKU: 13410



Base Bracket B

SKU: 14403



Me micro Switch A

SKU: 13600



Me 4 Button

SKU: 13602



Me Joystick

SKU: 13603



Me Potentiometer

SKU: 13604



Me Shutter

SKU: 13605



Me Micro Switch B

SKU: 13610



Me RJ25 Adapter

SKU: 13801

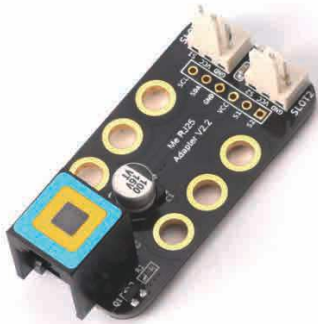

6AA Battery Holder

SKU: 14000



AC to DC 12V/2A Wall Adapter for Arduino/Meduno

SKU: 14008



Universal Plug Adapter Type G

SKU: 14016



Universal Plug Adapter Type E/F

SKU: 14017



Universal Plug Adapter for Europe (Type C)

SKU: 14018



6P6C RJ25 cable-20cm(4-Pack)

SKU: 14202



6P6C RJ25 cable-35cm(4-Pack)

SKU: 14204



6P6C RJ25 cable-50cm(Pair)

SKU: 14206



**USB 2.0 A-Male to
Micro B-Male Cable**

SKU: 14221



Shutter Cable C1 for Canon

SKU: 14225



Shutter Cable C3for Canon

SKU: 14226



Shutter Cable N1 for Nikon

SKU: 14227



Shutter Cable N3 for Nikon

SKU: 14228



**1.75mm PLA Filament -1Kg
(Blue)**

SKU: 20203



**1.75mm PLA Filament -1Kg
(Red)**

SKU: 20201



**1.75mm PLA Filament -1Kg
(Yellow)**

SKU: 20202



