

Grove - RGB LED (WS2813 Mini)

SKU 104020169

We have already released Grove RGB LED Ring and Grove RGB LED Stick. Here comes a new product called Grove - RGB LED (WS2813 Mini).

Grove - RGB LED uses the same component WS2813 mini compared with Grove - RGB LED ring. It can be programmed with full display colour and be used for connecting other RGB LED rings or RGB LED sticks by series mode.

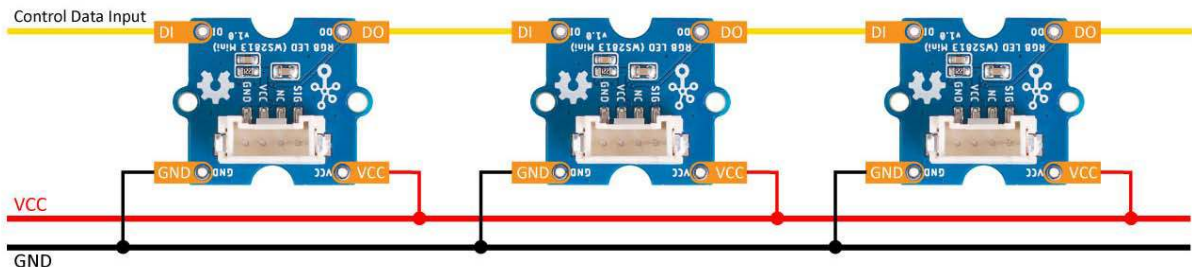

For example, if you want to build up a Olympic rings with LED, you can choose RGB LED rings for the Olympic rings and this RGB LED for the bridge to connect the Olympic rings together. Cause they are from the same type and they can be driven by the same power supplier. Besides, you can get a couple of LED to scrabble any pattern you like. So hope you get one and finish your amazing project!

Features

- 256 gray levels, $256 \times 256 \times 256 = 16777216$ full-color display
- Built-in control circuit in a 3535 components
- Chainable, can be cascaded with multiple LED rings
- Support 5V/3.3V power in, support 5V/3.3V control data level.
- Dual-signal wires, signal break-point continuous transmission

Signal break-point continuous transmission

Work

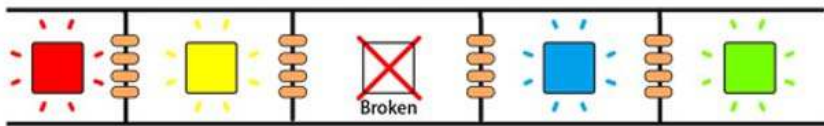

Work



Not Work

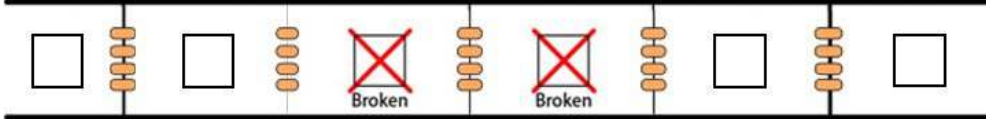

As long as not two or more adjacent LEDs are broken, the remaining LEDs will be able to work normally

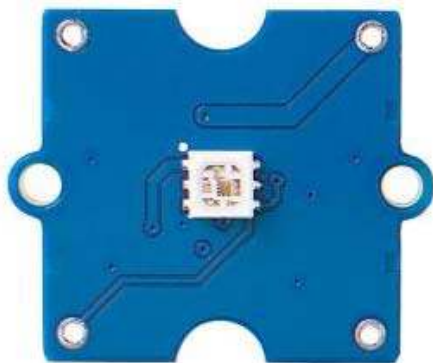

Hardware Overview

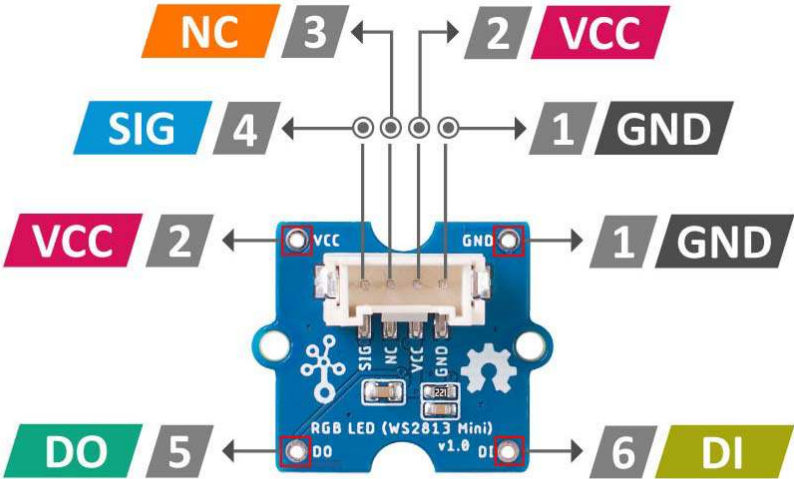

- 1** : Connected to the system GND
- 2** : Power supply from Grove 5V/3.3V
- 3** : Not connected
- 4** : Control data signal input from Grove connector
- 5** : Control data signal output
- 6** : Control data signal input

ECCN/HTS

HSCODE	9405409000
UPC	

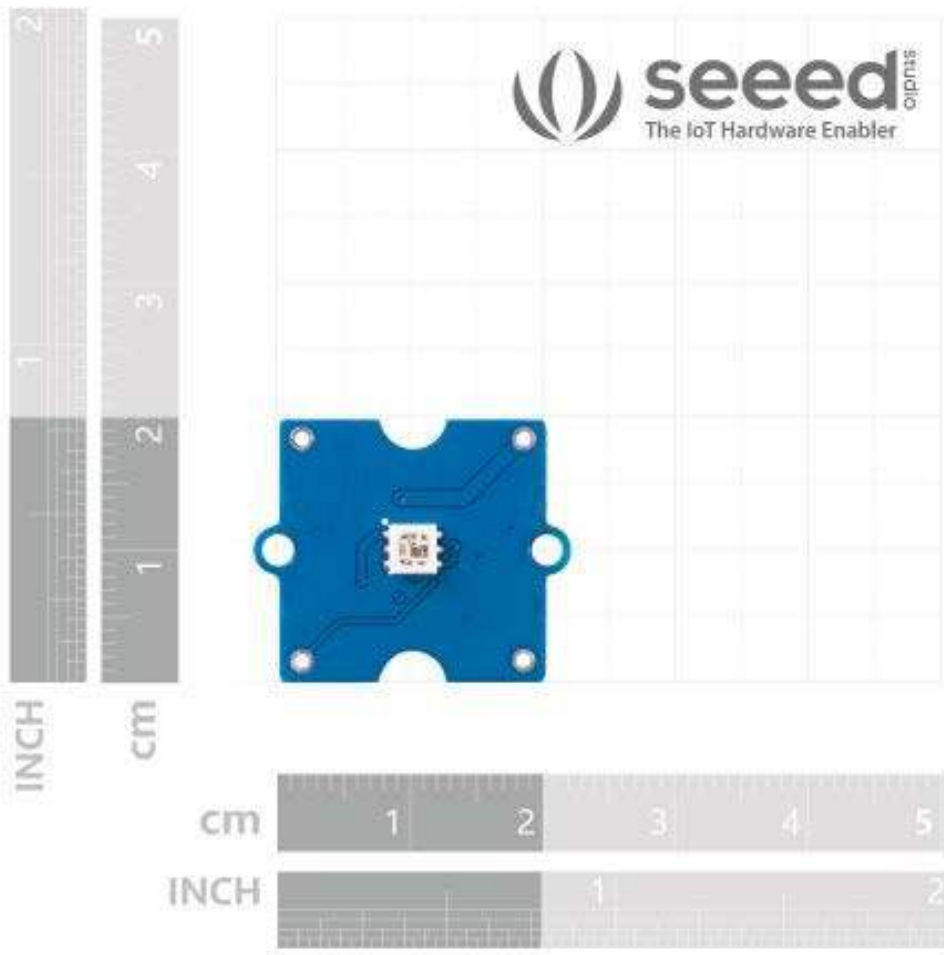
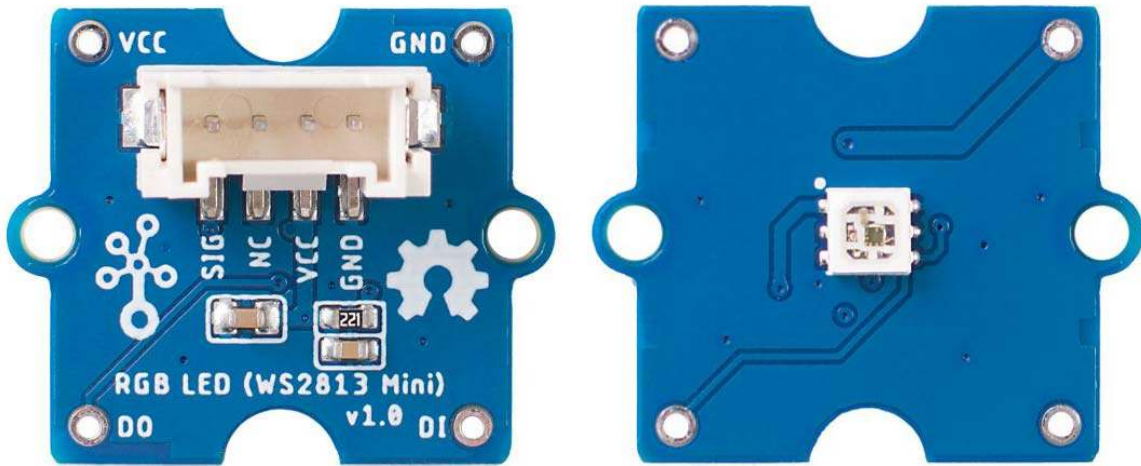

<https://www.seeedstudio.com/Grove-RGB-LED-WS2813-Mini-p-4269.html/10-3-19>