







### Plankonvexlinsen, gefasst







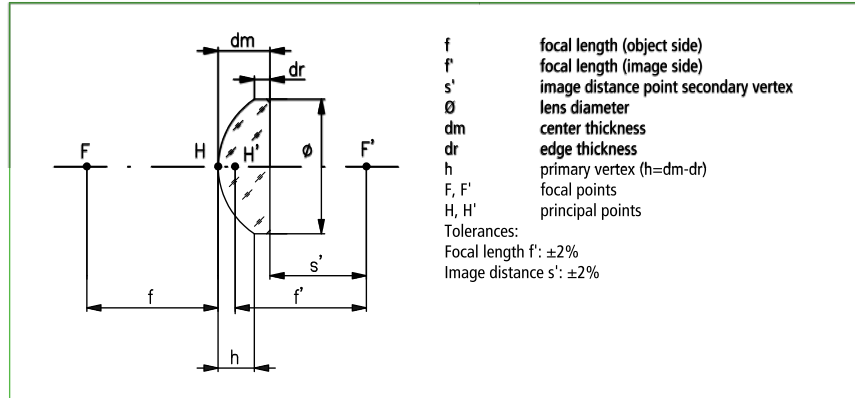
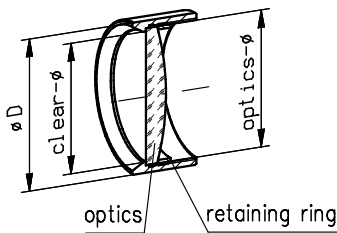



















- In Fassungen kompatibel zur Mikrobank  oder Nanobank 
- Unbeschichtet
- Toleranzen: Brennweite  $f'$ :  $\pm 2\%$ , Bildentfernung  $s'$ :  $\pm 2\%$

### Plano-Convex Lenses, Mounted

- *Lens mounts fit to Microbench  or Nanobench *
- *Surfaces uncoated*
- *Tolerances: Focal length  $f'$ :  $\pm 2\%$ , Image distance  $s'$ :  $\pm 2\%$*



### Plankonvexlinsen, gefasst Plano-convex lenses, mounted

Fassung	Brennweite (mm)	Optik-Ø (mm)	Material	Außen-Ø D (mm)	Freier-Ø (mm)	dm (mm)	dr (mm)	$s'_{588\text{ nm}}$ (mm)	$f'_{546\text{ nm}}$ (mm)	⊙*	Part No.
Mount	Focal length (mm)	Ø optics (mm)	Material	Outer-Ø D (mm)	Clear Ø (mm)	dm (mm)	dr (mm)	$s'_{588\text{ nm}}$ (mm)	$f'_{546\text{ nm}}$ (mm)	⊙*	Part No.
	2.5	3	N-LaSF9	16	2.5	1	0.38	1.96	2.48	1	G052101000
	3	3	N-BK7	16	2.5	1.5	0.34	2.01	2.99	1	G052102000
	5	5	N-BK7	16	4	2.5	0.57	3.35	4.98	3	G052103000
	6	6	N-BK7	16	5	3	0.68	4.02	5.98	3	G052104000
	10	6	N-BaK2	16	5	2	1.1	8.82	10.08	3	G052105000
	8	8	N-BK7	16	7	4	0.91	5.36	7.97	3	G052106000
	10	10	N-BK7	16	9	5	1.14	6.7	9.96	9	G052107000
	15	10	N-BaK4	16	9	3	1.4	12.99	14.84	9	G052108000
	20	12.5	N-BK7	16	11.5	3.5	1.4	17.9	20.13	9	G052109000
	25	12.5	N-BK7	16	11.5	3	1.4	23.27	25.16	9	G052110000
	30	12.7	N-BK7	16	11.5	3	1.6	28.03	29.9	9	G052111000
	50	12.7	N-BK7	16	11.5	3	2.2	48.41	50.2	9	G052112000
	80	12.7	N-BK7	16	11.5	3	2.5	77.88	79.56	9	G052113000
	100	12.7	N-BK7	16	11.5	3	2.6	97.12	98.73	9	G052114000
	150	12.7	N-BK7	16	11.5	3	2.7	147.36	148.79	9	G052115000
	200	12.7	N-BK7	16	11.5	3	2.8	197.17	198.41	9	G052116000
	30	18	N-BK7	25	17	4.5	1.7	27.48	30.33	9	G063042000
	40	22.4	N-BK7	25	21.4	5	1.7	37.02	40.16	13	G063043000
	50	22.4	N-BK7	25	21.4	4.5	2	48.15	50.93	13	G063044000
	60	22.4	N-BK7	25	21.4	4	2	59	61.4	13	G063045000
	80	22.4	N-BK7	25	21.4	3.5	1.9	78.71	80.71	13	G063046000
	100	22.4	N-BK7	25	21.4	3.2	2	99.15	100.88	13	G063047000
	150	22.4	N-BK7	25	21.4	3	2.2	149.54	150.94	13	G063048000
	200	22.4	N-BK7	25	21.4	2.7	2.1	200.27	201.28	13	G063049000
	50	25.4	N-BK7	30	24	5	1.8	47.09	50.2	13	G063821000
	80	25.4	N-BK7	30	24	4	2	77.88	79.56	13	G063822000

⊙\* Eine Tabelle mit weiteren Spezifikationen finden Sie zu Beginn dieses Kapitels.  
Please find more specifications in the table at the beginning of this chapter.

Optikdurchmesser 25.4 und 31.5 mm auf der nächsten Seite.  
See next page regarding optics diameter of 25.4 and 31.5 mm.

**Plankonvexlinsen, gefasst**  
**Plano-convex lenses, mounted**

Fassung	Brennweite (mm)	Optik-Ø (mm)	Material	Außen-Ø D (mm)	Freier-Ø (mm)	dm (mm)	dr (mm)	$s'_{588\text{ nm}}$ (mm)	$f'_{546\text{ nm}}$ (mm)	C*	Part No.
Mount	Focal length (mm)	Ø optics (mm)	Material	Outer-Ø D (mm)	Clear Ø (mm)	dm (mm)	dr (mm)	$s'_{588\text{ nm}}$ (mm)	$f'_{546\text{ nm}}$ (mm)	C*	Part No.
☐	100	25.4	N-BK7	30	24	4	2.4	96.46	98.73	13	G063823000
☐	150	25.4	N-BK7	30	24	4	3	148.87	150.94	13	G063824000
☐	200	25.4	N-BK7	30	24	4	3.2	196.51	198.41	13	G063825000
☐	300	25.4	N-BK7	30	24	4	3.5	295.33	296.86	13	G063826000
☐	500	25.4	N-BK7	30	24	4	3.7	501.22	501.98	13	G063827000
☐	1000	25.4	N-BK7	30	24	4	3.8	981.21	980.2	13	G063828000
☐	40	31.5	N-BaK4	35	30	8.3	2	34.92	40.04	13	G063101000
☐	50	31.5	N-BaK4	35	30	6.7	2	45.99	50.05	13	G063102000
☐	60	31.5	N-BK7	35	30	6.3	2.1	57.48	61.4	13	G063051000
☐	80	31.5	N-BK7	35	30	5	1.9	77.14	80.14	13	G063103000
☐	100	31.5	N-BK7	35	30	4.5	2.1	98.3	100.88	13	G063052000
☐	150	31.5	N-BK7	35	30	4	2.4	148.33	150.41	13	G063104000
☐	200	31.5	N-BK7	35	30	3.2	2	199.21	200.57	13	G063105000
☐	300	31.5	N-BK7	35	30	3	2.2	299.23	300.09	13	G063106000

C\* Eine Tabelle mit weiteren Spezifikationen finden Sie zu Beginn dieses Kapitels.  
 Please find more specifications in the table at the beginning of this chapter.

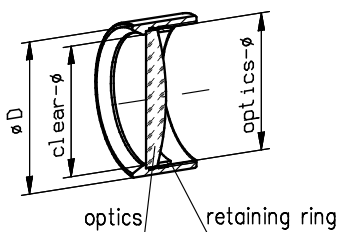

**Plankonvexlinsen, gefasst, aus Quarzglas**     **Plano-Convex Lenses, Mounted (Fused Silica)**

- In Fassungen kompatibel zur Mikrobank ☐ oder Nanobank ☒
- *Lens mounts fit to Microbench ☐ or Nanobench ☒*
- Unbeschichtet
- *Surfaces uncoated*
- Toleranzen: Brennweite  $f'$ :  $\pm 2\%$ , Bildentfernung  $s'$ :  $\pm 2\%$
- Tolerances: Focal length  $f'$ :  $\pm 2\%$ , Image distance  $s'$ :  $\pm 2\%$

