

| Features  |
|---|
| • Magnetic Shielded Structure                           |
| • Composite Structure                                   |
| • Ultra Low Buzz Noise                                  |
| • Low Loss, High Efficiency, Wide Application Frequency |
| • Lightweight Design, High Density SMD                  |

| Applications                      |
|-----------------------------------|
| • Use in Buck Converter           |
| • Laptops                         |
| • Displayer                       |
| • Network Communication Equipment |

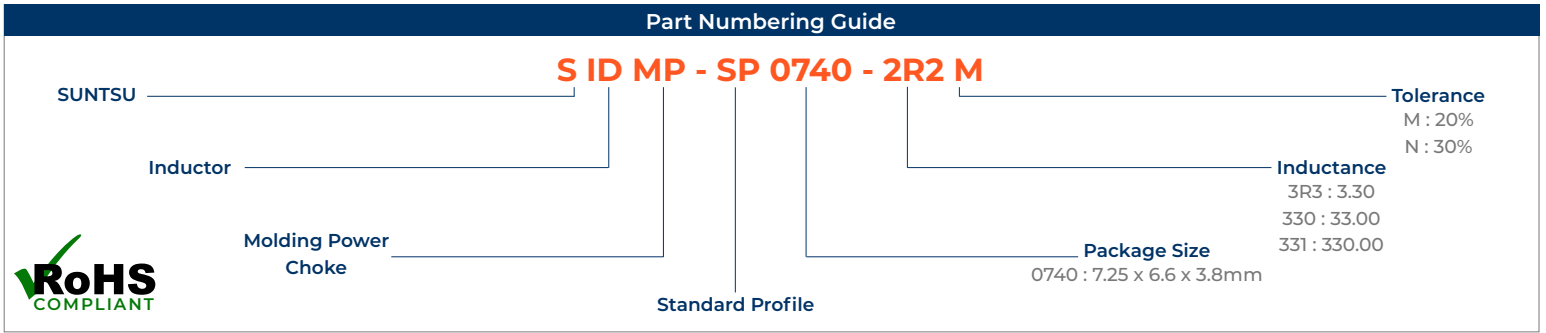

| Part Number       | Inductance (μH) | Tolerance | D.C.R. (mΩ)<br>Typical | D.C.R. (mΩ)<br>Max | Saturation Current (A)<br>Typical | Temp. Rise Current (A)<br>Typical |
|-------------------|-----------------|-----------|------------------------|--------------------|-----------------------------------|-----------------------------------|
| SIDMP-SP0740-R13M | 0.13            | ±20%      | 0.60                   | 0.80               | 50.00                             | 35.00                             |
| SIDMP-SP0740-R15M | 0.15            | ±20%      | 0.65                   | 0.80               | 50.00                             | 34.00                             |
| SIDMP-SP0740-R22M | 0.22            | ±20%      | 2.05                   | 2.50               | 35.00                             | 28.00                             |
| SIDMP-SP0740-R36M | 0.36            | ±20%      | 2.50                   | 3.10               | 25.00                             | 21.50                             |
| SIDMP-SP0740-R47M | 0.47            | ±20%      | 3.25                   | 3.60               | 21.00                             | 19.00                             |
| SIDMP-SP0740-R68M | 0.68            | ±20%      | 4.10                   | 4.80               | 21.00                             | 17.00                             |
| SIDMP-SP0740-1R0M | 1.00            | ±20%      | 5.50                   | 6.60               | 18.50                             | 14.60                             |
| SIDMP-SP0740-1R5M | 1.50            | ±20%      | 7.70                   | 9.50               | 12.50                             | 12.40                             |
| SIDMP-SP0740-1R8M | 1.80            | ±20%      | 9.20                   | 11.20              | 13.00                             | 11.40                             |
| SIDMP-SP0740-2R2M | 2.20            | ±20%      | 11.00                  | 15.00              | 11.00                             | 10.40                             |
| SIDMP-SP0740-3R3M | 3.30            | ±20%      | 16.60                  | 20.00              | 9.50                              | 8.40                              |
| SIDMP-SP0740-4R7M | 4.70            | ±20%      | 27.30                  | 30.00              | 9.00                              | 6.50                              |
| SIDMP-SP0740-5R6M | 5.60            | ±20%      | 36.50                  | 38.00              | 7.00                              | 5.70                              |
| SIDMP-SP0740-6R8M | 6.80            | ±20%      | 40.60                  | 50.00              | 6.00                              | 5.40                              |
| SIDMP-SP0740-8R2M | 8.20            | ±20%      | 47.50                  | 55.00              | 6.00                              | 5.00                              |
| SIDMP-SP0740-100M | 10.00           | ±20%      | 51.50                  | 65.00              | 6.00                              | 4.80                              |
| SIDMP-SP0740-150M | 15.00           | ±20%      | 86.30                  | 95.00              | 4.50                              | 3.70                              |
| SIDMP-SP0740-220M | 22.00           | ±20%      | 107.00                 | 125.00             | 4.00                              | 3.30                              |
| SIDMP-SP0740-330M | 33.00           | ±20%      | 199.00                 | 220.00             | 3.00                              | 2.40                              |
| SIDMP-SP0740-390M | 39.00           | ±20%      | 244.00                 | 280.00             | 2.80                              | 2.20                              |
| SIDMP-SP0740-470M | 47.00           | ±20%      | 256.00                 | 298.00             | 2.50                              | 2.10                              |

Saturation Current vs Temperature Rise Current Curve

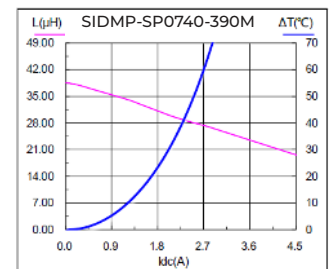
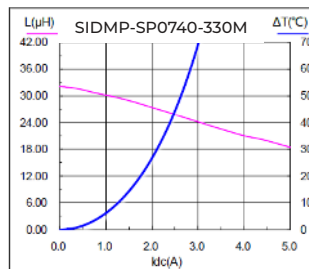
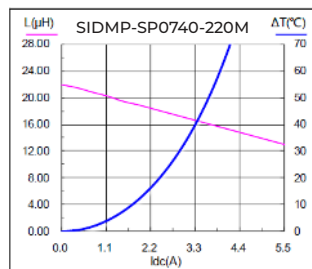
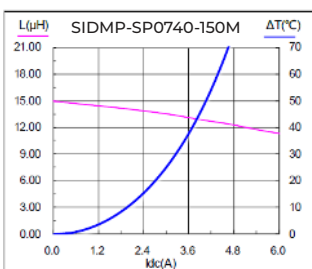
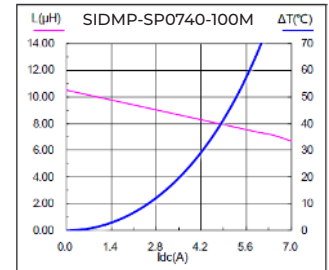
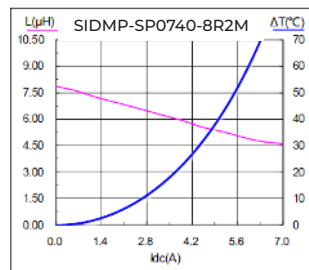
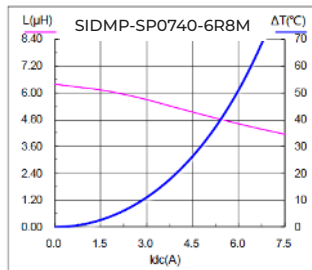
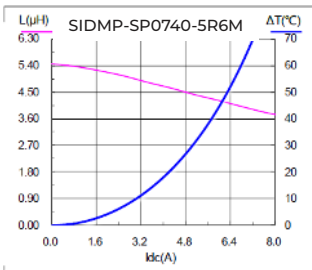
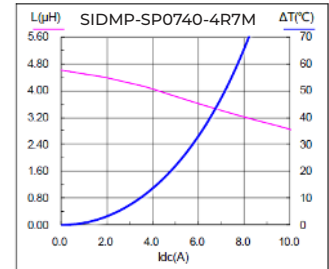
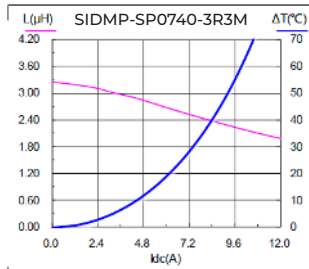
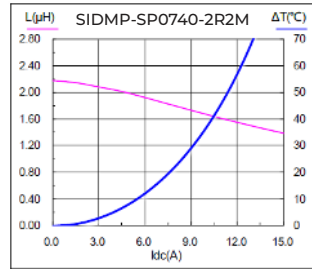
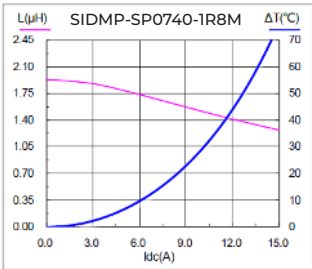
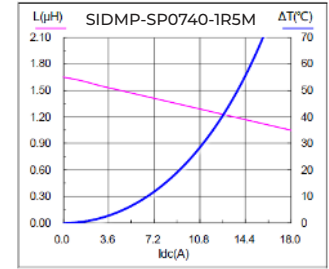
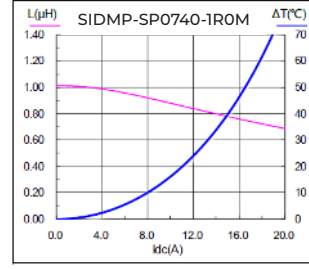
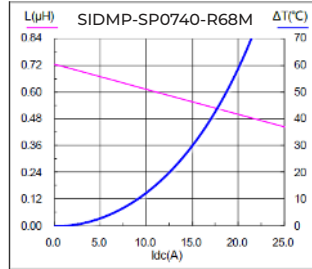
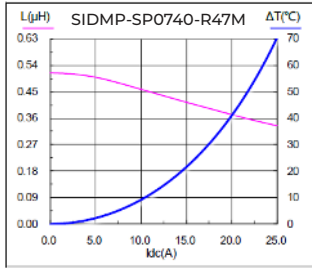
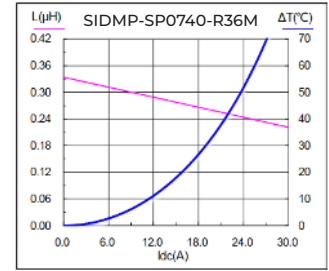
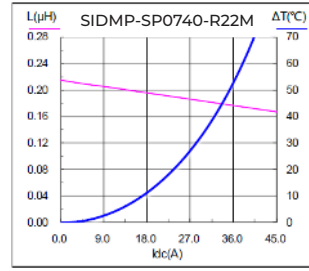
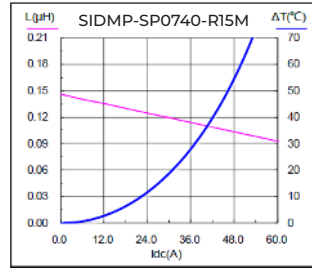
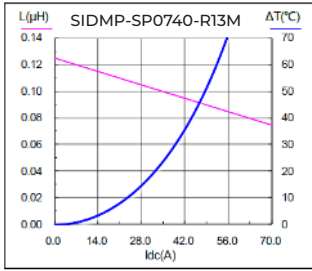

Saturation Current vs Temperature Rise Current Curve

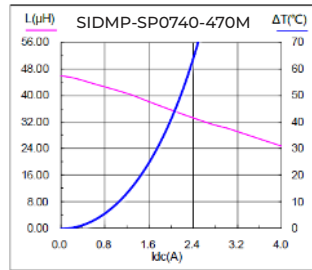

- All Data is tested based on 25°C ambient temperature.
- Inductance measure condition at 100kHz, 1.0V.
- Saturation current: The actual value of DC current when the inductance decrease 30% of its initial value.
- Temperature rise current: The actual value of DC current when the temperature rise is  $\Delta T 40^{\circ}\text{C}$  ( $T_a=25^{\circ}\text{C}$ ).
- Reminder: Circuit design, component placement, PCB size and thickness, cooling system and etc. will all affect the product temperature.
- Please verify the product temperature in the final application.

Outline Drawing & Land Pattern

All dimensions are in millimeters (mm) unless otherwise noted. Drawings are not to scale.

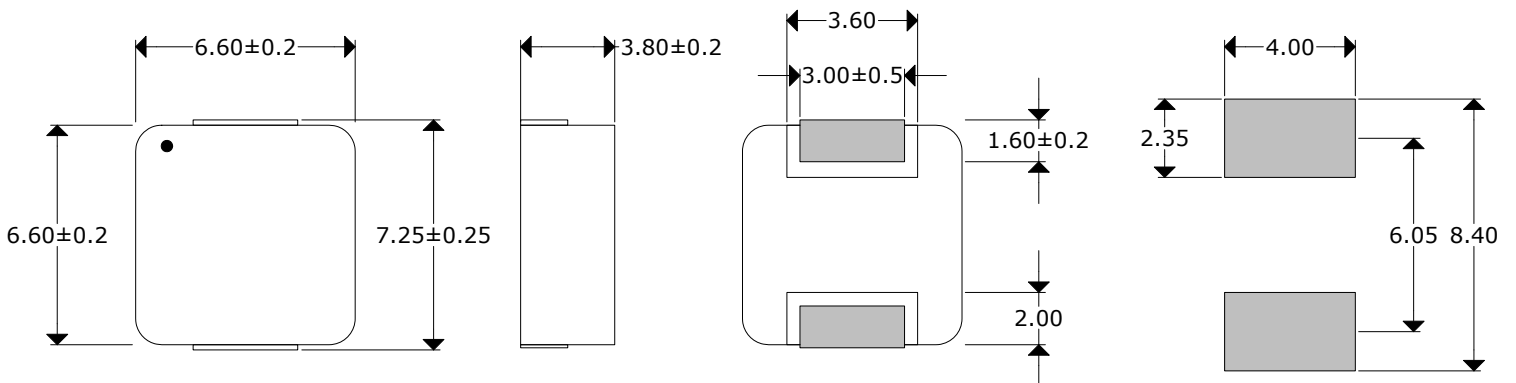

### Reflow Profile & Part Marking

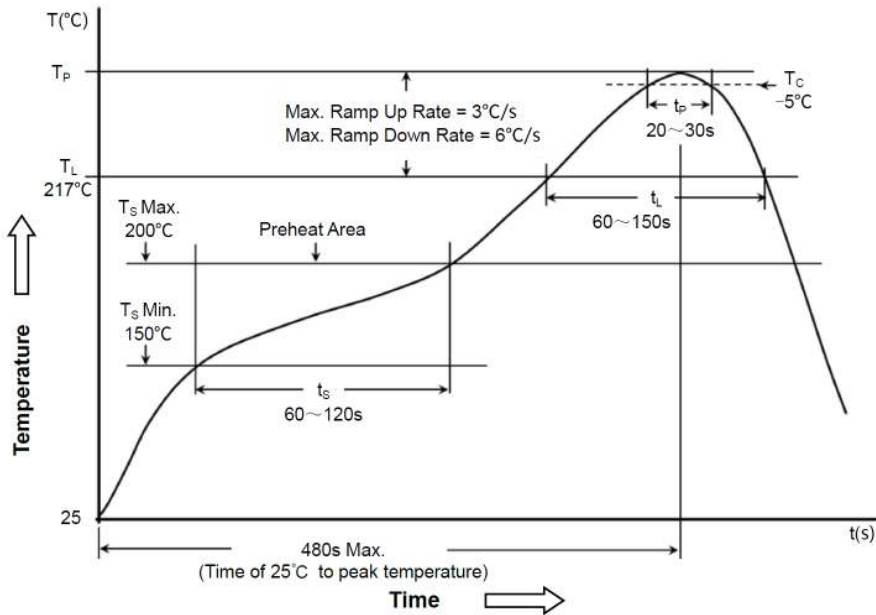

Line 1 : X X X

Inductance ( $\mu\text{H}$ )

Classification of Peak Package Body Temperature ( $T_p$ )

|                  | Package Thickness | Package Volume        |                          |                       |
|------------------|-------------------|-----------------------|--------------------------|-----------------------|
|                  |                   | < 350 mm <sup>3</sup> | 350~2000 mm <sup>3</sup> | >2000 mm <sup>3</sup> |
| PB-Free Assembly | <1.6mm            | 260°C                 | 260°C                    | 260°C                 |
|                  | 1.6~2.5mm         | 260°C                 | 250°C                    | 245°C                 |
|                  | ≥2.5mm            | 250°C                 | 245°C                    | 245°C                 |

**Example:**  
 3.30 $\mu\text{H}$  : 3R3  
 33.00 $\mu\text{H}$  : 33R  
 330.00 $\mu\text{H}$  : 331  
 3300.00 $\mu\text{H}$  : 332

### Tape And Reel Dimensions

All dimensions are in millimeters (mm) unless otherwise noted. Drawings are not to scale.

1000pcs / Reel

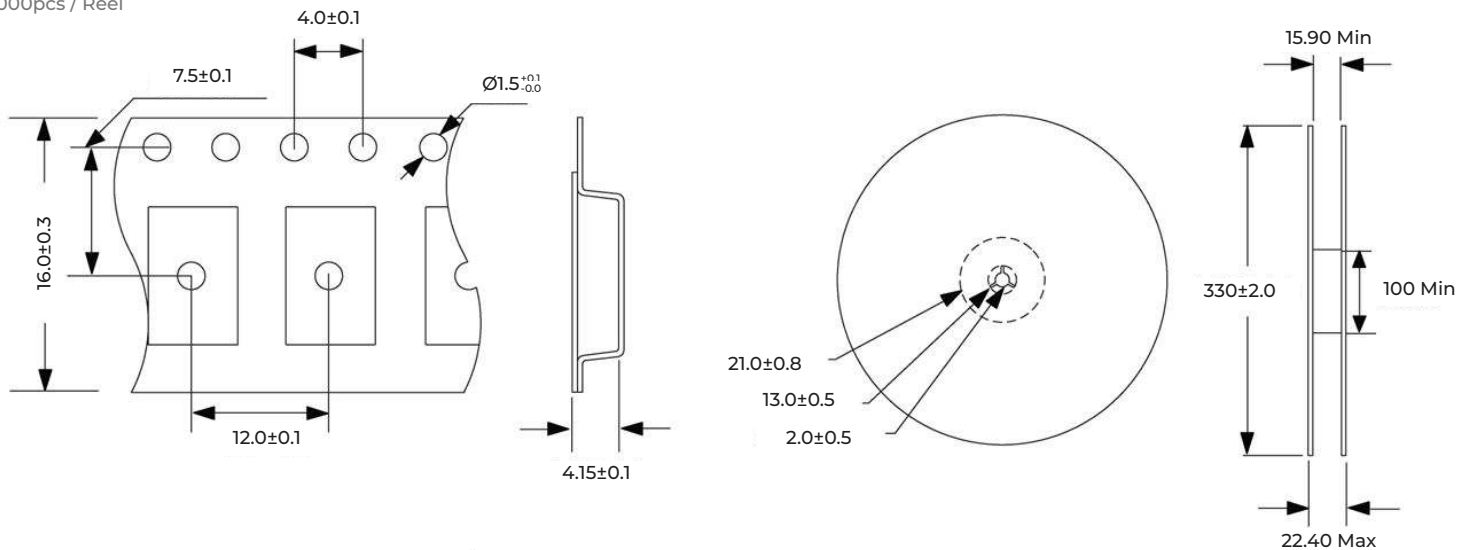

| Environmental Specifications |                                       | Mechanical Specifications    |                                       |
|------------------------------|---------------------------------------|------------------------------|---------------------------------------|
| Temperature Cycling          | MIL-STD-883, Method 1010, Condition B | Mechanical Shock             | MIL-STD-202, Method 213, Condition C  |
| Fine Leak Test               | MIL-STD-883, Method 1014, Condition A | Vibration                    | MIL-STD-883, Method 2007, Condition A |
| Gross Leak Test              | MIL-STD-883, Method 1014, Condition C | Resistance to Soldering Heat | MIL-STD-202, Method 210, Condition K  |
| Moisture Resistance          | MIL-STD-883, Method 1004              | Resistance to Solvents       | MIL-STD-202, Method 215               |
| Moisture Sensitivity         | J-STD-020, MSL 1                      | Solderability                | MIL-STD-883, Method 2003              |

| Notice of Use  |   |
|--|---|
| 1. Product in packing storage condition : temperature 5~40°C, RH ≤ 70%.  | 6. When this product will be used on a similar or new project to the original one, sometimes it might be unable to satisfy the specifications due to different condition of usage.  |
| 2. A storage of inductors longer than 12 months is not recommended. Within other effects, the terminals may suffer degradation, resulting in bad solderability. Therefore, all products shall be used within the period of 12 months based on the day of shipment. | 7. This inductor itself does not have any protective function in abnormal condition, such as overload, short-circuit, open-circuit conditions, etc. Therefore, it shall be confirmed that there is no risk of smoke, fire, dielectric withstand voltage, insulation resistance, etc. or use in abnormal conditions protective devices or protection circuit in the end product. |
| 3. Do not keep products in unsuitable storage conditions, such as areas susceptible to high temperatures, high humidity, dust or corrosion.  | 8. Hi-Pot test with higher voltage than spec will damage material and shorten its life.   |
| 4. Always handle product with care.  | 9. If using in potting compound, the magnet wire coating might be damaged.  |
| 5. Don't touch electrodes directly with bare hands as oil secretions may inhibit soldering. Always ensure optimum conditions for soldering.  | 10. Refrain from rinsing coils.   |