

PX3226

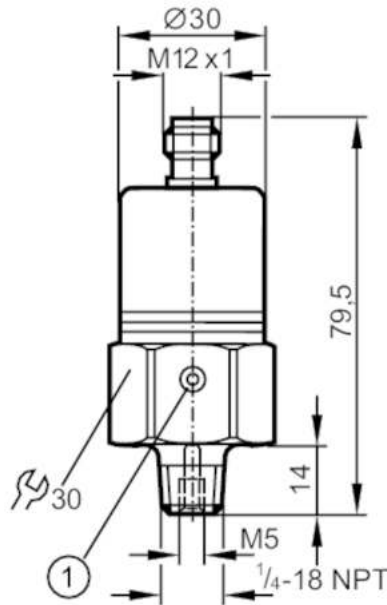

Pressure transmitter with ceramic measuring cell

PA-003PRBN14-A-ZVG/US/ IV



1 ventilation



Product characteristics

Number of inputs and outputs	Number of analogue outputs: 1
Measuring range [psi]	0...30
Process connection	threaded connection 1/4" NPT external thread internal thread:M5

Application

Special feature	Gold-plated contacts
Application	for industrial applications
Media	liquids and gases
Medium temperature [°C]	-25...90
Min. bursting pressure [psi]	725
Pressure rating [psi]	290
Type of pressure	relative pressure

Electrical data

Operating voltage [V]	9.6...32 DC
Min. insulation resistance [MΩ]	100; (500 V DC)
Protection class	III
Reverse polarity protection	yes

Inputs / outputs

Number of inputs and outputs	Number of analogue outputs: 1
------------------------------	-------------------------------

Outputs

Total number of outputs	1
Output signal	analogue signal
Number of analogue outputs	1

PX3226



Pressure transmitter with ceramic measuring cell

PA-003PRBN14-A-ZVG/US/ IV

Analogue current output	[mA]	4...20
Max. load	[Ω]	720; (U _b = 24 V; (U _b - 9,6 V) / 20 mA)
Overload protection		yes
Measuring/setting range		
Measuring range	[psi]	0...30
Accuracy / deviations		
Repeatability	[% of the span]	< 0,15; (with temperature fluctuations < 10 K)
Characteristics deviation	[% of the span]	< ± 0,35 (BFSL) / < ± 0,75 (LS); (BFSL = Best Fit Straight Line; LS = limit value setting)
Long-term stability	[% of the span]	< ± 0,05; (per 6 months)
Temperature coefficient zero point	[% of the span / 10 K]	0,2; (0...80 °C)
Temperature coefficient span	[% of the span / 10 K]	0,3; (0...80 °C)
Response times		
Step response time analogue output	[ms]	3
Operating conditions		
Ambient temperature	[°C]	-25...80
Storage temperature	[°C]	-40...100
Protection		IP 65
Tests / approvals		
EMC	EN 61000-4-2 ESD	4 kV CD / 8 kV AD
	EN 61000-4-3 HF radiated	30 V/m
	EN 61000-4-4 Burst	2 kV
	EN 61000-4-6 HF conducted	10 V
	radiation of interference	according to the automotive directive 2004/104/EC / CISPR 25
	immunity	according to the automotive directive 2004/104/EC / ISO 11452-2
	HF radiated	100 V/m
Shock resistance	pulse resistance	ISO 7637-2 / severity level 3
	DIN IEC 68-2-27	50 g (11 ms)
Vibration resistance	DIN IEC 68-2-6	20 g (10...2000 Hz)
MTTF	[years]	555
Pressure Equipment Directive		Sound engineering practice; can be used for group 2 fluids; group 1 fluids on request
Mechanical data		
Weight	[g]	213
Materials		stainless steel (1.4404 / 316L); FKM; PA; EPDM/X
Materials (wetted parts)		stainless steel (1.4305 / 303); ceramics; FKM
Min. pressure cycles		100 million
Process connection		threaded connection 1/4" NPT external thread internal thread:M5
Restrictor element integrated		no (can be retrofitted)

PX3226



Pressure transmitter with ceramic measuring cell

PA-003PRBN14-A-ZVG/US/ IV

Remarks

Pack quantity

1 pcs.

Electrical connection

Connector: 1 x M12; coding: A; Contacts: gold-plated



Connection

