

High Voltage LED Series Chip on Board

LC013B Gen.2



High efficacy COB LED package,
well-suited for use in spotlight applications

Features & Benefits

- Chip on Board (COB) solution makes it easy to design in
- Simple assembly reduces manufacturing cost
- Low thermal resistance
- InGaN/GaN MQW LED with long time reliability
- Completed 6,000 hours of LM-80 Testing
- ENEC certified: Integral LED Module

Applications

- Spotlight / Downlight
- LED Retrofit Bulbs
- Outdoor Illumination



Table of Contents

1.	Characteristics	-----	3
2.	Product Code Information	-----	6
3.	Typical Characteristics Graphs	-----	13
4.	Outline Drawing & Dimension	-----	18
5.	Reliability Test Items & Conditions	-----	19
6.	Label Structure	-----	20
7.	Packing Structure	-----	22
8.	Precautions in Handling & Use	-----	25

1. Characteristics

a) Absolute Maximum Rating

Item	Symbol	Rating	Unit	Condition
Ambient / Operating Temperature	T_a	-40 ~ +105	°C	-
Storage Temperature	T_{stg}	-40 ~ +120	°C	-
LED Junction Temperature	T_j	150	°C	-
Case Temperature	T_c	105	°C	*Note
Forward Current	I_F	660	mA	-
Power Dissipation	P_D	24.4	W	-
ESD (HBM)	-	±2	kV	-
ESD (MM)	-	±0.5	kV	-

b) Electro-optical Characteristics ($I_F = 360 \text{ mA}$, $T_c = 25 \text{ °C}$)

Item	Unit	Rank	Min.	Typ.	Max.
Forward Voltage (V_F)	V	YH	32.5	35.5	38.5
Color Rendering Index (R_a)	-	3	70	-	-
		5	80	-	-
		7	90	-	-
		8	95	-	-
Thermal Resistance (junction to chip point)	°C/W		-	1.6	-
Beam Angle	°		-	115	-
Nominal Power	W			12.8	
Eye Protection		Risk 1	-		-

Notes:

- 1) The COB is tested in pulsed condition at rated test current (10 ms pulse width) and rated temperature ($T_j = T_c = T_a = 25 \text{ °C}$)
- 2) Samsung maintains measurement tolerance of: forward voltage = $\pm 5 \%$, CRI = ± 1
- 3) Max $T_c = 105 \text{ °C}$ is for ENEC condition. Refer to the derating curve, '3. Typical Characteristics Graph' designed within the range.

c) Luminous Flux Characteristics ($I_F = 360 \text{ mA}$)

CRI (R_a) Min.	Nominal CCT (K)	Flux Rank	Flux Bin	Sorting ¹⁾ @ $T_c = 25 \text{ }^\circ\text{C}$ (lm)		Calculated Flux ²⁾ @ $T_c = 85 \text{ }^\circ\text{C}$ (lm)		
				Min.	Max.	Min.	Max.	
70	3000	1F	11	1633	1856	1470	1670	
			12	1856	2078	1670	1871	
	4000	1F	11	1715	1948	1543	1754	
			12	1948	2182	1754	1964	
	5000	1F	11	1731	1967	1558	1770	
			12	1967	2203	1770	1983	
	80	2700	1D	17	1700	1800	1547	1638
				18	1800	1900	1638	1729
1E			18	1800	1900	1638	1729	
			19	1900	2000	1729	1820	
3000		1D	17	1750	1850	1593	1684	
			18	1850	1950	1684	1775	
		1E	18	1850	1950	1684	1775	
			19	1950	2050	1775	1866	
3500		1D	18	1840	1950	1674	1775	
			19	1950	2060	1775	1875	
		1E	19	1950	2060	1775	1875	
			20	2060	2170	1875	1976	
4000		1D	18	1760	1870	1602	1702	
			19	1870	1980	1702	1802	
			1E	19	1870	1980	1702	1802
				20	1980	2090	1802	1902
		5000	1D	17	1680	1800	1529	1638
				18	1800	1920	1638	1747
			1E	18	1800	1920	1638	1747
				19	1920	2040	1747	1856
5700		1D	17	1680	1800	1529	1638	
			18	1800	1920	1638	1747	
		1E	18	1800	1920	1638	1747	
			19	1920	2040	1747	1856	

c) Luminous Flux Characteristics ($I_F = 360 \text{ mA}$)

CRI (R_a) Min.	Nominal CCT (K)	Flux Rank	Flux Bin	Sorting ¹⁾ @ $T_c = 25 \text{ }^\circ\text{C}$ (lm)		Calculated Flux ²⁾ @ $T_c = 85 \text{ }^\circ\text{C}$ (lm)		
				Min.	Max.	Min.	Max.	
90	2700	1G	14	1405	1520	1279	1383	
			15	1520	1670	1383	1520	
	3000	1G	14	1440	1560	1310	1420	
			15	1560	1710	1420	1556	
	3500	1G	14	1475	1595	1342	1451	
			15	1595	1745	1451	1588	
	4000	1G	14	1520	1645	1383	1497	
			15	16454	1795	1497	1633	
	95	2700	1E	11	1160	1289	1056	1173
				12	1289	1418	1173	1291
3000		1E	11	1196	1329	1089	1209	
			12	1329	1462	1209	1330	
3500		1E	11	1232	1369	1121	1246	
			12	1369	1506	1246	1370	

Notes:

- 1) The COB is tested in pulsed condition at rated test current (10 ms pulse width) and rated temperature ($T_j = T_c = T_a = 25 \text{ }^\circ\text{C}$)
- 2) Calculated flux values are for reference only
- 3) Samsung maintains measurement tolerance of: luminous flux = $\pm 7 \%$, CRI = ± 1

2. Product Code Information

1	2	3	4	5	6	7	8	9	10	11	12	13	14	15	16	17	18
S	P	H	C	W	1	H	D	N	A	2	5	Y	H	R	T	1	F

Digit	PKG Information	Code	Specification
1 2 3	Samsung Package High Power	SPH	
4 5	Color	WW CW	Warm White (T/U/V/W Ranks) Cool White (Q/R Ranks)
6	Product Version	1	
7 8	Form Factor	HD	COB
9	Lens Type	N	No lens
10	Internal Code	A	LC013
11	Chip Type	2	
12	CRI & Sorting Temperature	3 5 7 8	Min. 70 Min. 80 Min. 90 Min 95 25 °C
13 14	Forward Voltage (V)	YH	32.5~38.5
15	CCT (K)	W V U T R Q	2700 K 3000 K 3500 K 4000 K 5000 K 5700 K WA, WB (MacAdam Ellipse) VA, VB (MacAdam Ellipse) UA, UB (MacAdam Ellipse) TA, TB (MacAdam Ellipse) RA (MacAdam Ellipse) Bin Code: VW, VX, VY, VZ (ANSI bin) TW, TX, TY, TZ (ANSI bin) RW, RX, RY, RZ (ANSI bin) QW, QX, QY, QZ (ANSI bin)
16	MacAdam / ANSI	2 3 T	MacAdam 2-step MacAdam 3-step ANSI bin
17 18	Luminous Flux	1D 1E 1F 1G	17, 18, 19 (80 CRI) 18, 19, 20 (80 CRI) 11, 12 (95 CRI) Bin Code: 11, 12 (70 CRI) 14, 15 (80 CRI)

a) Binning Structure ($I_F = 360 \text{ mA}$, $T_c = 25 \text{ }^\circ\text{C}$)

CRI (R _a) Min.	Nominal CCT (K)	Product Code	V _F Rank	Color Rank	Chrom. Bin	Flux Rank	Flux Bin	Flux Range (Φ _v , lm)
70	3000	SPHWW1HDNA23YHVT1F	YH	VT	VW, VX VY, VZ	1F	11	1633 ~ 1856
							12	1856 ~ 2078
	4000	SPHWW1HDNA23YHTT1F	YH	TT	TW, TX TY, TZ	1F	11	1715 ~ 1948
							12	1948 ~ 2182
	5000	SPHCW1HDNA23YHRT1F	YH	RT	RW, RX RY, RZ	1F	11	1731 ~ 1967
							12	1967 ~ 2203
80	2700	SPHWW1HDNA25YHW21D	YH	W2	WB	1D	17	1700 ~ 1800
							18	1800 ~ 1900
		SPHWW1HDNA25YHW31D	YH	W3	WA, WB	1D	17	1700 ~ 1800
							18	1800 ~ 1900
		SPHWW1HDNA25YHW21E	YH	W2	WB	1E	18	1800 ~ 1900
							19	1900 ~ 2000
	SPHWW1HDNA25YHW31E	YH	W3	WA, WB	1E	18	1800 ~ 1900	
						19	1900 ~ 2000	
	3000	SPHWW1HDNA25YHV21D	YH	V2	VB	1D	17	1750 ~ 1850
							18	1850 ~ 1950
		SPHWW1HDNA25YHV31D	YH	V3	VA, VB	1D	17	1750 ~ 1850
							18	1850 ~ 1950
		SPHWW1HDNA25YHV21E	YH	V2	VB	1E	18	1850 ~ 1950
							19	1950 ~ 2050
	SPHWW1HDNA25YHV31E	YH	V3	VA, VB	1E	18	1850 ~ 1950	
						19	1950 ~ 2050	
	3500	SPHWW1HDNA25YHU21D	YH	U2	UB	1D	18	1840 ~ 1950
							19	1950 ~ 2060
		SPHWW1HDNA25YHU31D	YH	U3	UA, UB	1D	18	1840 ~ 1950
							19	1950 ~ 2060
		SPHWW1HDNA25YHU21E	YH	U2	UB	1E	19	1950 ~ 2060
							19	1950 ~ 2060
	SPHWW1HDNA25YHU31E	YH	U3	UA, UB	1E	19	1950 ~ 2060	
						19	1950 ~ 2060	
4000	SPHWW1HDNA25YHT21D	YH	T2	TB	1D	18	1760 ~ 1870	
						19	1870 ~ 1980	
	SPHWW1HDNA25YHT31D	YH	T3	TA, TB	1D	18	1760 ~ 1870	
						19	1870 ~ 1980	
	SPHWW1HDNA25YHT21E	YH	T2	TB	1E	19	1870 ~ 1980	
						20	1980 ~ 2090	
SPHWW1HDNA25YHT31E	YH	T3	TA, TB	1E	19	1870 ~ 1980		
					20	1980 ~ 2090		
5000	SPHCW1HDNA25YHR31D	YH	R3	RA	1D	17	1680 ~ 1800	
						18	1800 ~ 1920	
	SPHCW1HDNA25YHRT1D	YH	RT	RW, RX, RY, RZ	1D	17	1680 ~ 1800	
						18	1800 ~ 1920	
	SPHCW1HDNA25YHR31E	YH	R3	RA	1E	18	1800 ~ 1920	
						19	1920 ~ 2040	
SPHCW1HDNA25YHRT1E	YH	RT	RW, RX, RY, RZ	1E	18	1800 ~ 1920		
					19	1920 ~ 2040		
5700	SPHCW1HDNA25YHQT1D	YH	QT	QW, QX, QY, QZ	1D	17	1680 ~ 1800	
						18	1800 ~ 1920	
SPHCW1HDNA25YHQT1E	YH	QT	QW, QX, QY, QZ	1E	18	1800 ~ 1920		
					19	1920 ~ 2040		

a) Binning Structure ($I_F = 360 \text{ mA}$, $T_c = 25 \text{ }^\circ\text{C}$)

CRI (R_a) Min.	Nominal CCT (K)	Product Code	V_F Rank	Color Rank	Chrom. Bin	Flux Rank	Flux Bin	Flux Range (Φ_v , lm)	
90	2700	SPHWW1HDNA27YHW31G	YH	W3	WB	1G	14	1405 ~ 1520	
							15	1520 ~ 1670	
		SPHWW1HDNA27YHW21G	YH	W2	WA, WB	1G	14	1405 ~ 1520	
							15	1520 ~ 1670	
		SPHWW1HDNA27YHV21G	YH	V2	VB	1G	14	1440 ~ 1560	
							15	1560 ~ 1710	
	SPHWW1HDNA27YHV31G	YH	V3	VA, VB	1G	14	1440 ~ 1560		
						15	1560 ~ 1710		
	3500	SPHWW1HDNA27YHU21G	YH	U2	UB	1G	14	1475 ~ 1595	
							15	1595 ~ 1745	
		SPHWW1HDNA27YHU31G	YH	U3	UA, UB	1G	14	1475 ~ 1595	
							15	1595 ~ 1745	
		SPHWW1HDNA27YHT21G	YH	T2	TB	1G	14	1520 ~ 1645	
							15	1645 ~ 1795	
	SPHWW1HDNA27YHT31G	YH	T3	TA, TB	1G	14	1520 ~ 1645		
						15	1645 ~ 1795		
	95	2700	SPHWW1HDNA28YHW21E	YH	W2	WB	1E	11	1160 ~ 1289
								12	1289 ~ 1418
SPHWW1HDNA28YHW31E			YH	W3	WA, WB	1E	11	1160 ~ 1289	
							12	1289 ~ 1418	
3000		SPHWW1HDNA28YHV21E	YH	V2	VB	1E	11	1169 ~ 1329	
							12	1329 ~ 1462	
		SPHWW1HDNA28YHV31E	YH	V3	VA, VB	1E	11	1169 ~ 1329	
							12	1329 ~ 1462	
3500		SPHWW1HDNA28YHU21E	YH	U2	UB	1E	11	1232 ~ 1369	
							12	1369 ~ 1506	
		SPHWW1HDNA28YHU31E	YH	U3	UA, UB	1E	11	1232 ~ 1369	
							12	1369 ~ 1506	

b) Chromaticity Region & Coordinates ($I_f = 360 \text{ mA}$, $T_a = 25 \text{ }^\circ\text{C}$)

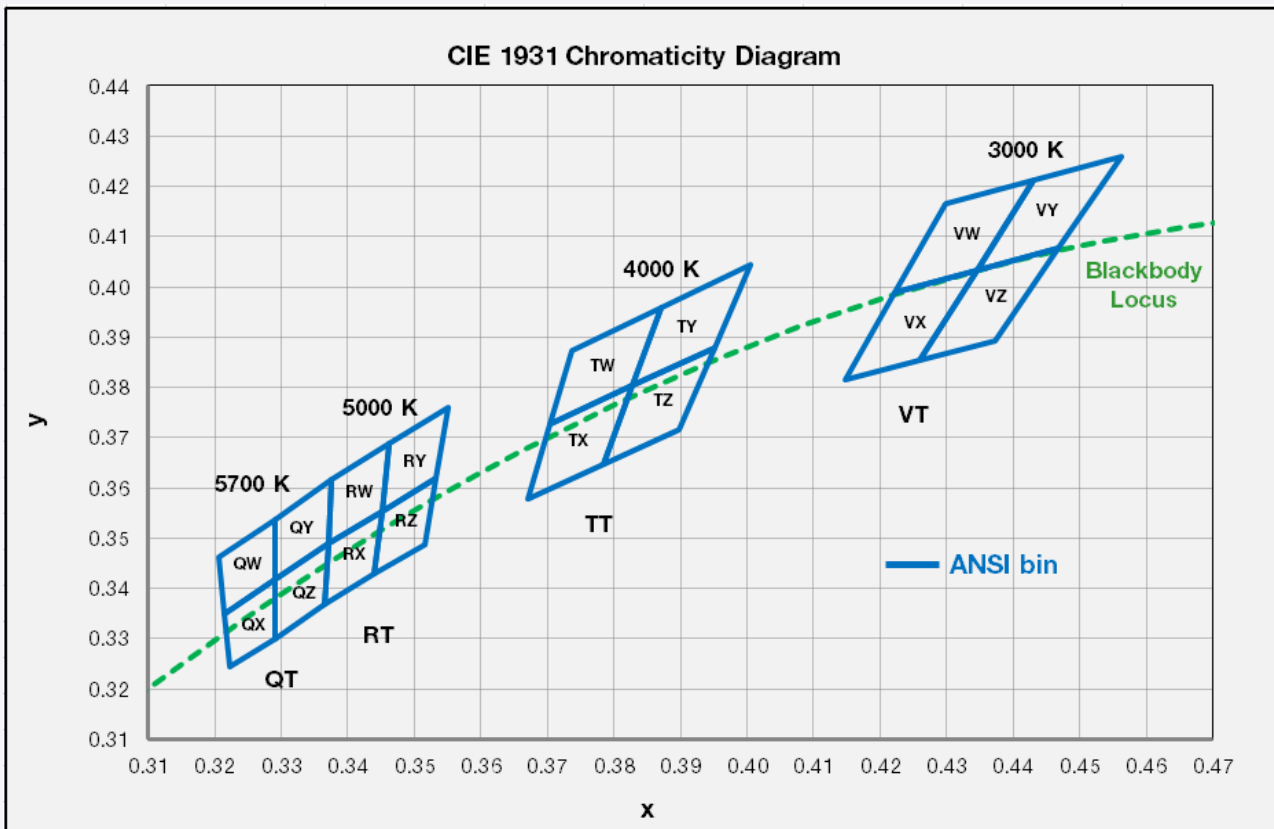

Region	CIE x	CIE y	Region	CIE x	CIE y
V rank (3000 K)					
VW	0.4223	0.399	VY	0.4345	0.4033
	0.4345	0.4033		0.4468	0.4077
	0.4431	0.4213		0.4562	0.4260
	0.4299	0.4165		0.4431	0.4213
VX	0.4223	0.399	VZ	0.4260	0.3854
	0.4147	0.3814		0.4373	0.3893
	0.4260	0.3854		0.4468	0.4077
	0.4345	0.4033		0.4345	0.4033
R rank (5000 K)					
RW	0.3376	0.3616	RY	0.3463	0.3687
	0.3463	0.3687		0.3551	0.3760
	0.3451	0.3554		0.3533	0.3620
	0.3371	0.3490		0.3451	0.3554
RX	0.3371	0.3490	RZ	0.3451	0.3554
	0.3451	0.3554		0.3533	0.3620
	0.3440	0.3428		0.3515	0.3487
	0.3366	0.3369		0.3440	0.3428

Region	CIE x	CIE y	Region	CIE x	CIE y
T rank (4000 K)					
TW	0.3736	0.3874	TY	0.3871	0.3959
	0.3871	0.3959		0.4006	0.4044
	0.3828	0.3803		0.3952	0.388
	0.3703	0.3726		0.3828	0.3803
TX	0.3703	0.3726	TZ	0.3828	0.3803
	0.3828	0.3803		0.3952	0.388
	0.3784	0.3647		0.3898	0.3716
	0.367	0.3578		0.3784	0.3647
Q rank (5700 K)					
QW	0.3207	0.3462	QY	0.3290	0.3538
	0.3290	0.3538		0.3376	0.3616
	0.3290	0.3417		0.3371	0.3490
	0.3215	0.3350		0.3290	0.3417
QX	0.3215	0.3350	QZ	0.3290	0.3417
	0.3290	0.3417		0.3371	0.3490
	0.3290	0.3300		0.3366	0.3369
	0.3222	0.3243		0.3290	0.3300

b) Chromaticity Region & Coordinates ($I_F = 360 \text{ mA}$, $T_a = 25 \text{ }^\circ\text{C}$)

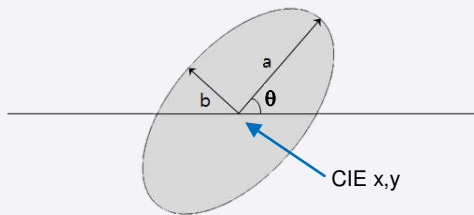
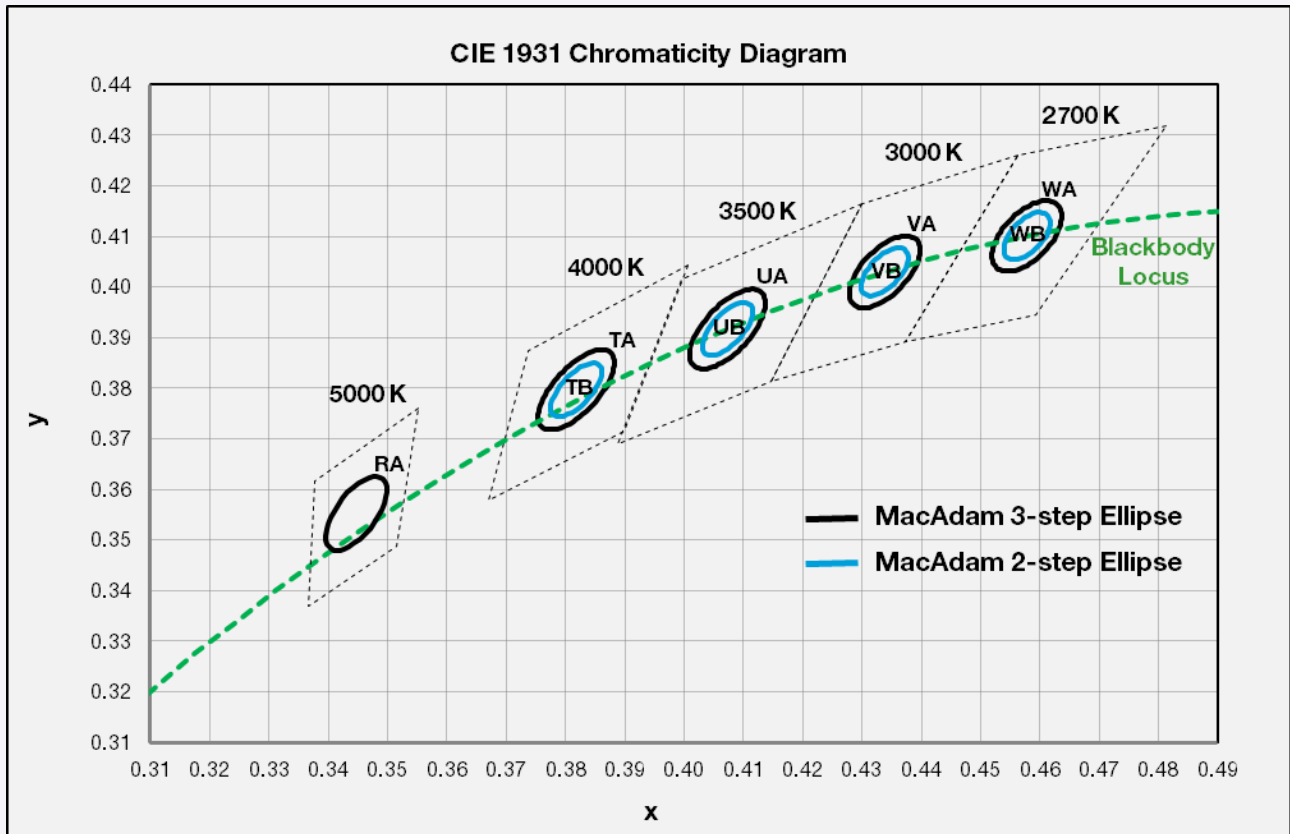

MacAdam Ellipse (WA, WB)					
Step	CIE x	CIE y	θ	a	b
2-step	0.4578	0.4101	53.70	0.0054	0.0028
3-step	0.4578	0.4101	53.70	0.0081	0.0042

MacAdam Ellipse (VA, VB)					
Step	CIE x	CIE y	θ	a	b
2-step	0.4338	0.403	53.22	0.0056	0.0027
3-step	0.4338	0.4030	53.22	0.0083	0.0041

MacAdam Ellipse (UA, UB)					
Step	CIE x	CIE y	θ	a	b
2-step	0.4073	0.3917	54.00	0.0062	0.0028
3-step	0.4073	0.3917	54.00	0.0093	0.0041

MacAdam Ellipse (TA, TB)					
Step	CIE x	CIE y	θ	a	b
2-step	0.3818	0.3797	53.72	0.0063	0.0027
3-step	0.3818	0.3797	53.72	0.0094	0.0040

MacAdam Ellipse (RA)					
Step	CIE x	CIE y	θ	a	b
3-step	0.3447	0.3553	59.62	0.0082	0.0035

Note:

Samsung maintains measurement tolerance of: $C_x, C_y = \pm 0.005$

3. Typical Characteristics Graphs

a) Spectrum Distribution ($I_f = 360 \text{ mA}$, $T_c = 25 \text{ }^\circ\text{C}$)

CCT: 2700 K (80 CRI)

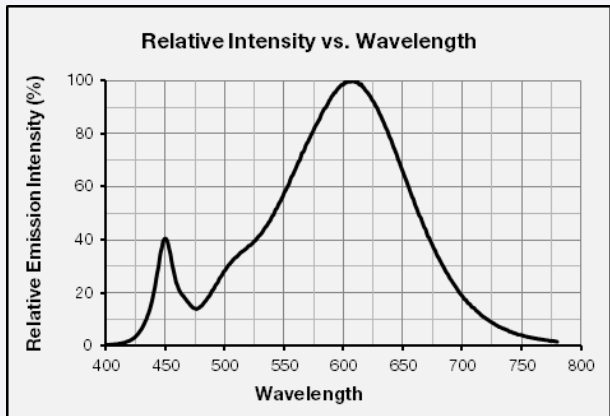

CCT: 3000 K (80 CRI)

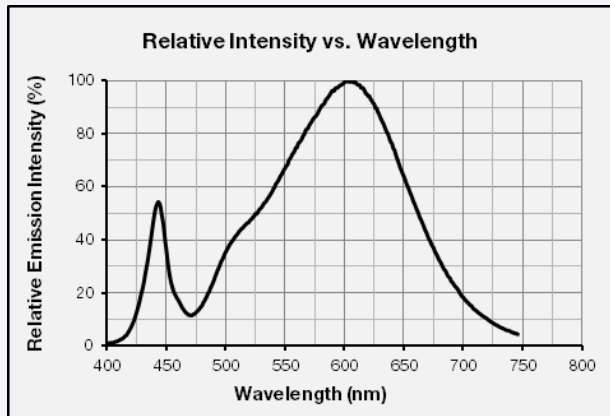

CCT: 3500 K (80 CRI)

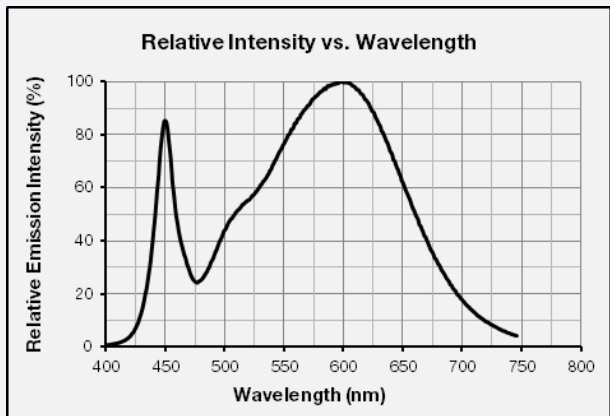

CCT: 4000 K (80 CRI)

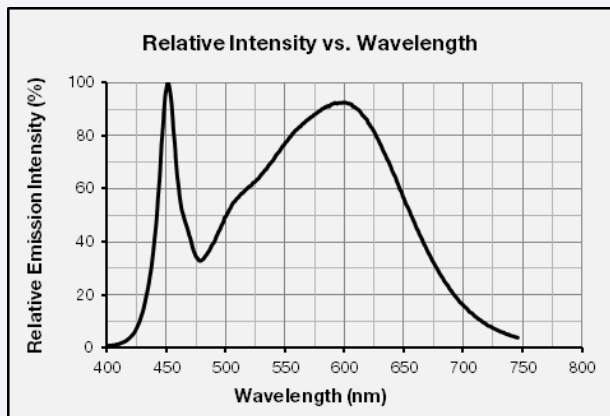

CCT: 5000 K (80 CRI)

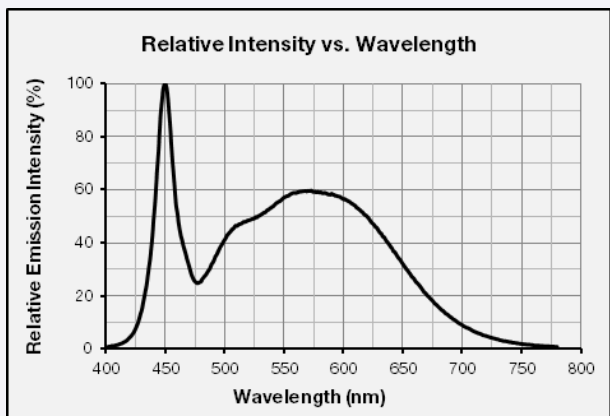

CCT: 5700 K (80 CRI)

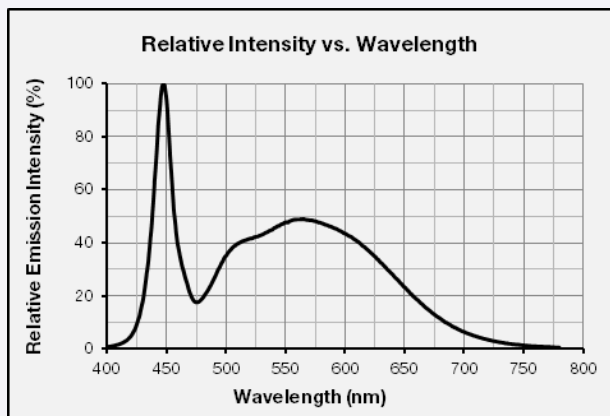

CCT: 2700 K (90 CRI)

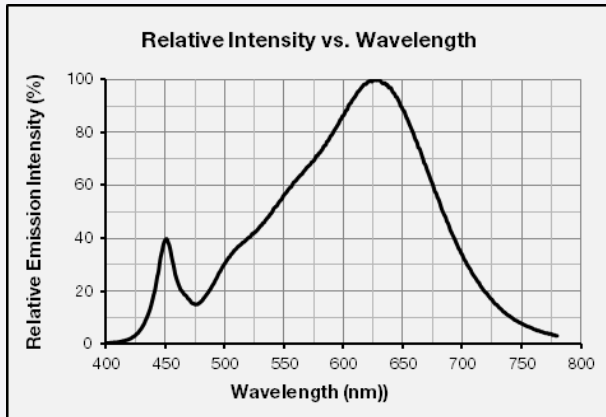

CCT: 3000 K (90 CRI)

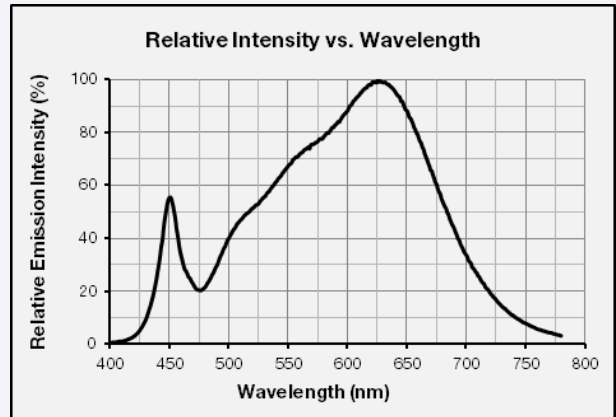

CCT: 3500 K (90 CRI)

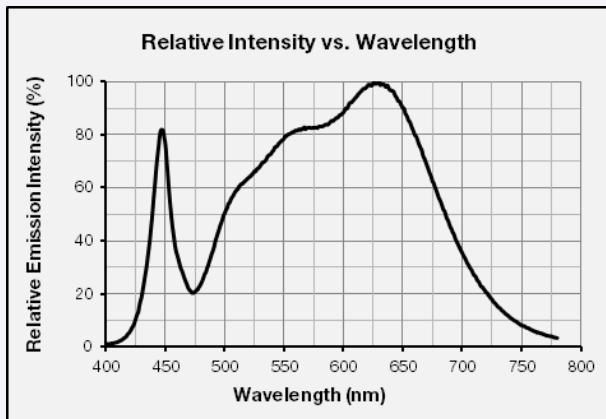

CCT: 4000 K (90 CRI)

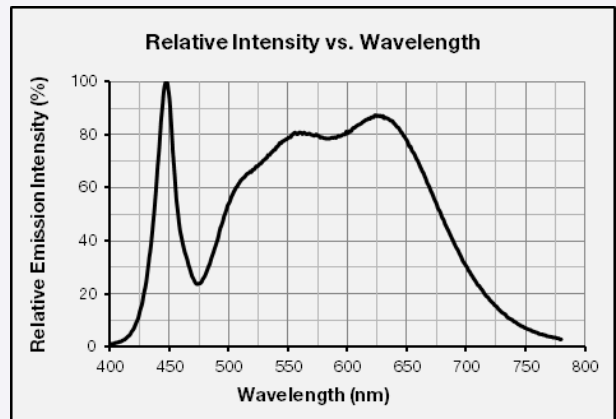

b) Forward Current Characteristics (T_c = 25 °C)

80 CRI

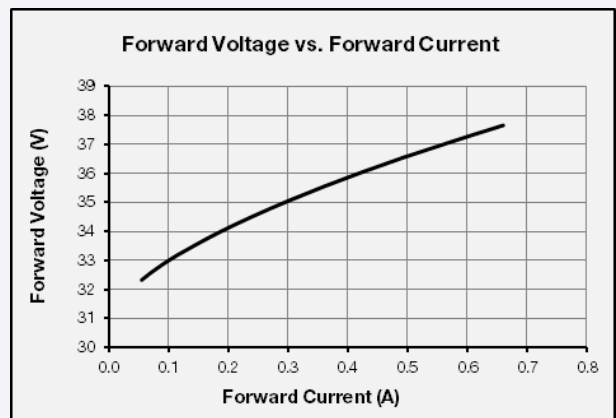
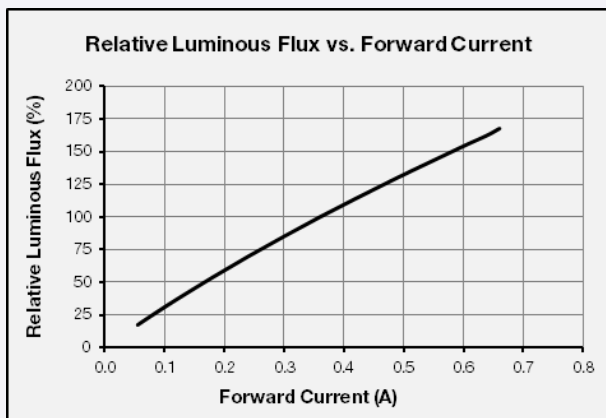

90 CRI

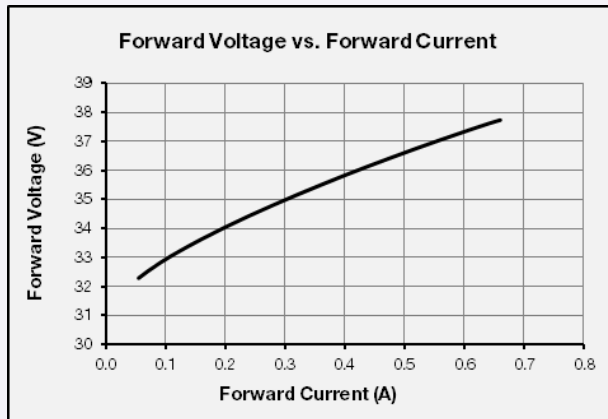
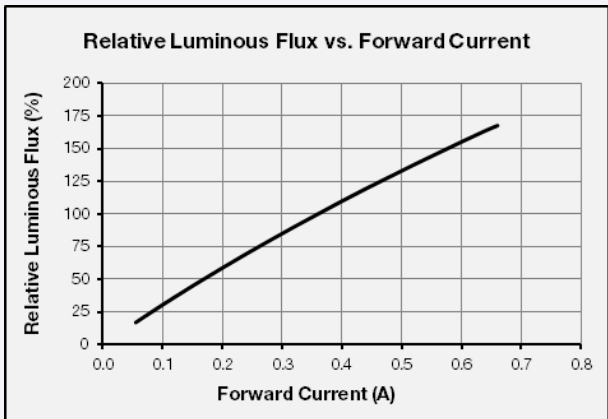

c) Temperature Characteristics (I_F = 360 mA)

80 CRI

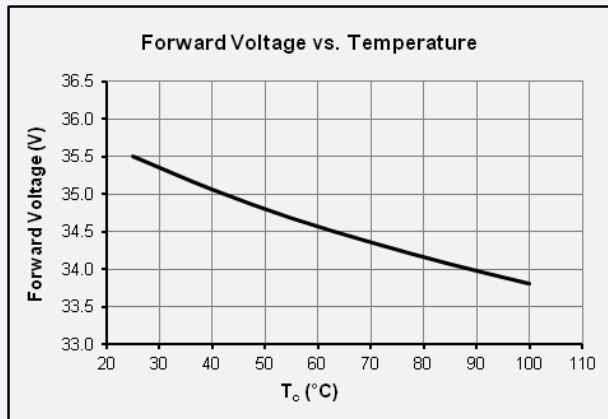
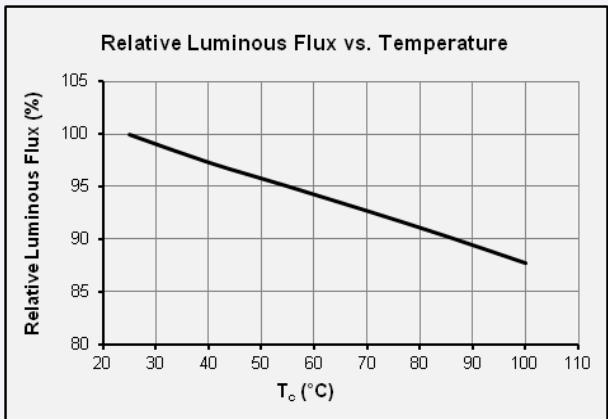

90 CRI

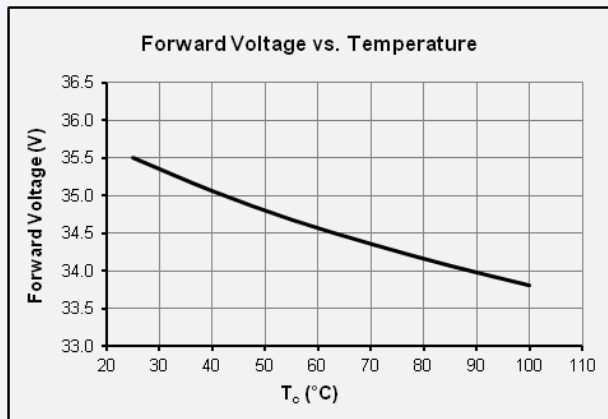
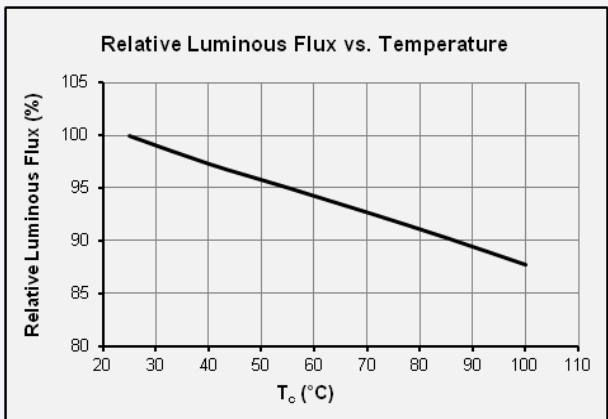

d) Color Shift Characteristics

$T_c = 25\text{ }^\circ\text{C}$

$I_f = 360\text{ mA}$

80 CRI

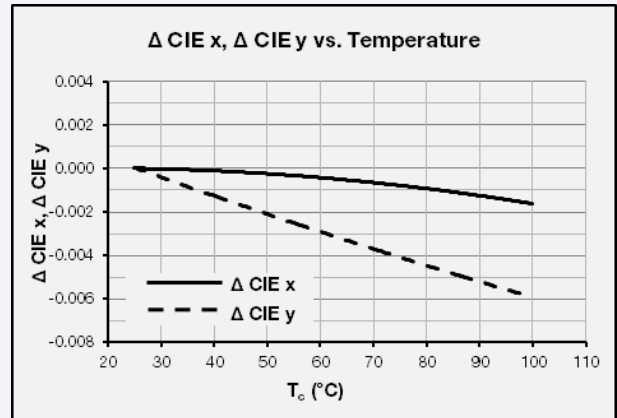
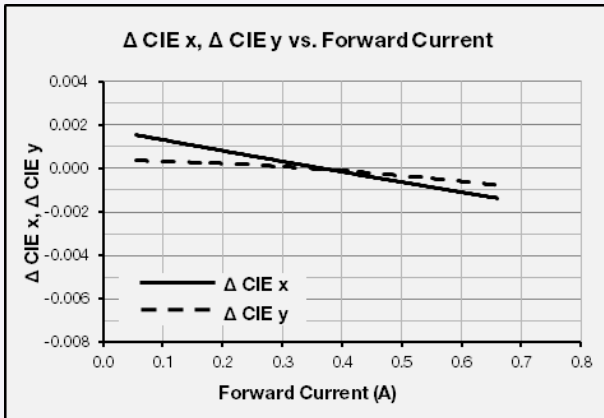

90 CRI

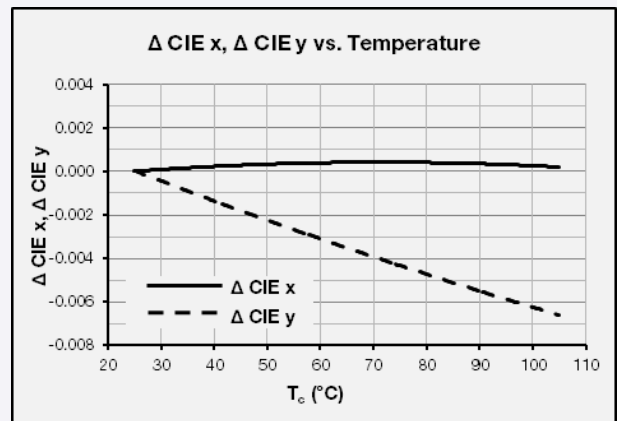
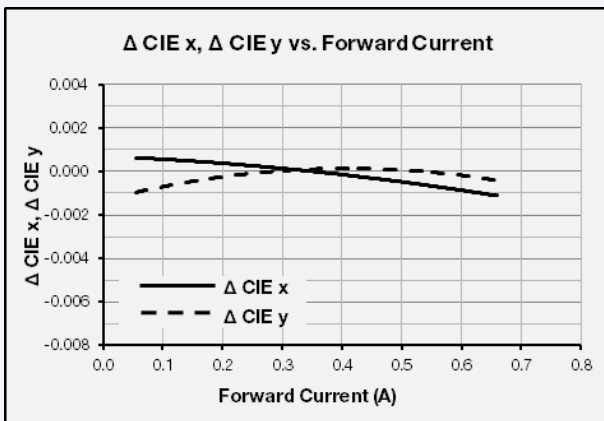

e) Derating Curve

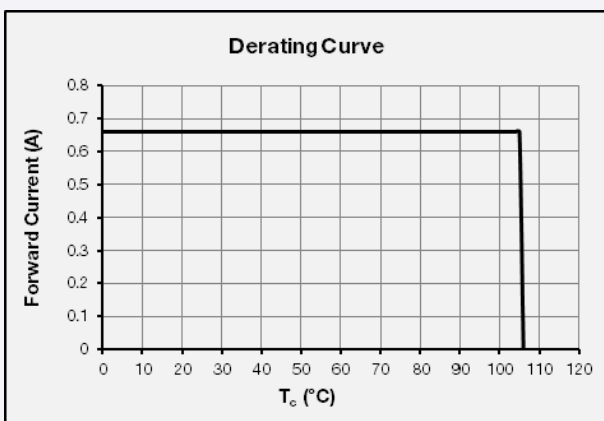

f) Beam Angle Characteristics ($I_F = 360 \text{ mA}$, $T_C = 25 \text{ }^\circ\text{C}$)

80 CRI

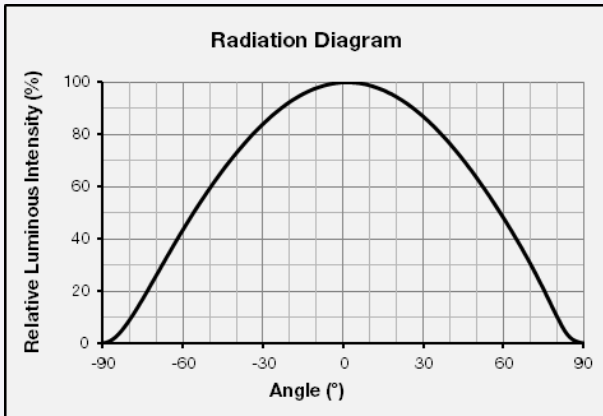

90 CRI

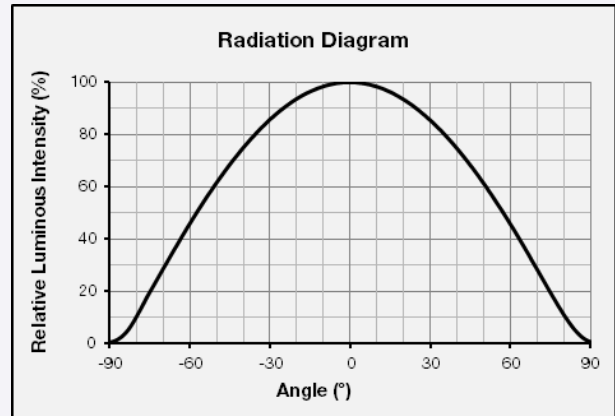

4. Outline Drawing & Dimension

- 1. Unit: mm
- 2. Tolerance: ± 0.15 mm

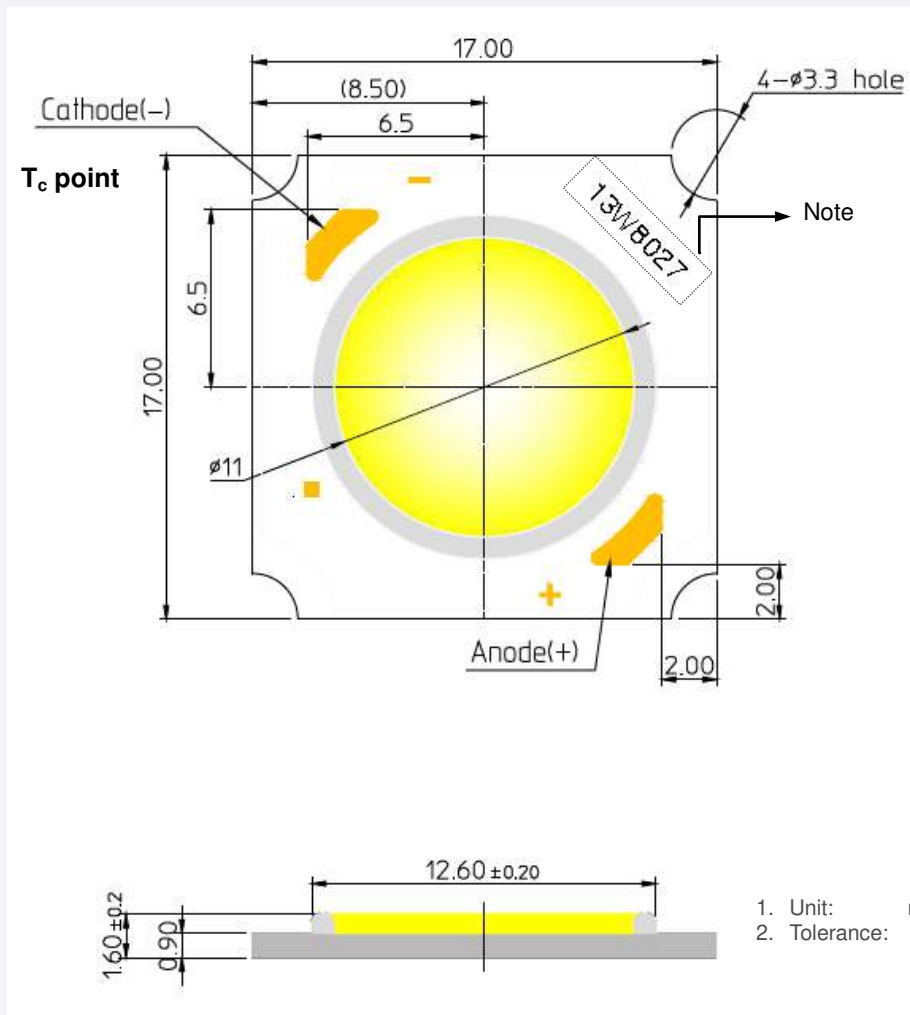

- 1. Unit: mm
- 2. Tolerance: ± 0.2 mm

Item	Dimension	Tolerance	Unit
Length	17.0	± 0.15	mm
Width	17.0	± 0.15	mm
Height	1.50	± 0.20	mm
Light Emitting Surface (LES) Diameter	11	± 0.15	mm

Note: Denoted product information above is only an example
 (13W8027 : 13W, CRI80+, 2700K)



5. Reliability Test Items & Conditions

a) Test Items

Test Item	Test Condition	Test Hour / Cycle
Room Temperature Life Test	25 °C, I _F = max	1000 h
High Temperature Humidity Life Test	85 °C, 85 % RH, DC Derating, I _F = max	1000 h
High Temperature Life Test	105 °C, DC Derating, I _F = max	1000 h
Low Temperature Life Test	-40 °C, DC 660 mA	1000 h
High Temperature Storage	120 °C	1000 h
Low Temperature Storage	-40 °C	1000 h
Thermal Shock	-45 °C / 15 min ↔ 125 °C / 15 min temperature change in 5 min	200 cycles
Temperature Cycle On/Off Test	-40 °C / 85 °C each 20 min, 100 min transfer power on/off each 5 min, DC 360 mA	100 cycles
Temperature Humidity Storage Test	-10 °C ↔ 25 °C, 95 % RH ↔ 85 °C, 95 % RH (24 h / cycle)	100 cycles
ESD (HBM)	R ₁ : 10 MΩ R ₂ : 1.5 kΩ C: 100 pF V: ±2 kV	5 times
ESD (MM)	R ₁ : 10 MΩ R ₂ : 0 kΩ C: 200 pF V: ±0.5 kV	5 times
Vibration Test	20 ~ 80 Hz (displacement: 0.06 inch, max. 20 g) 80 ~ 2 kHz (max. 20 g) min. frequency ↔ max. frequency 4 min transfer	4 times
Mechanical Shock Test	1500 g, 0.5 ms each of the 6 surfaces (3 axis x 2 sides)	5 times
Salt Spray Test	35 °C, 5 % salt water 8 h spray, 16 h dwell	2 cycles

b) Criteria for Judging the Damage

Item	Symbol	Test Condition (T _c = 25 °C)	Limit	
			Min.	Max.
Forward Voltage	V _F	I _F = 360 mA	L.S.L. * 0.9	U.S.L. * 1.1
Luminous Flux	Φ _v	I _F = 360 mA	L.S.L * 0.7	U.S.L * 1.3

6. Label Structure

a) Label Structure

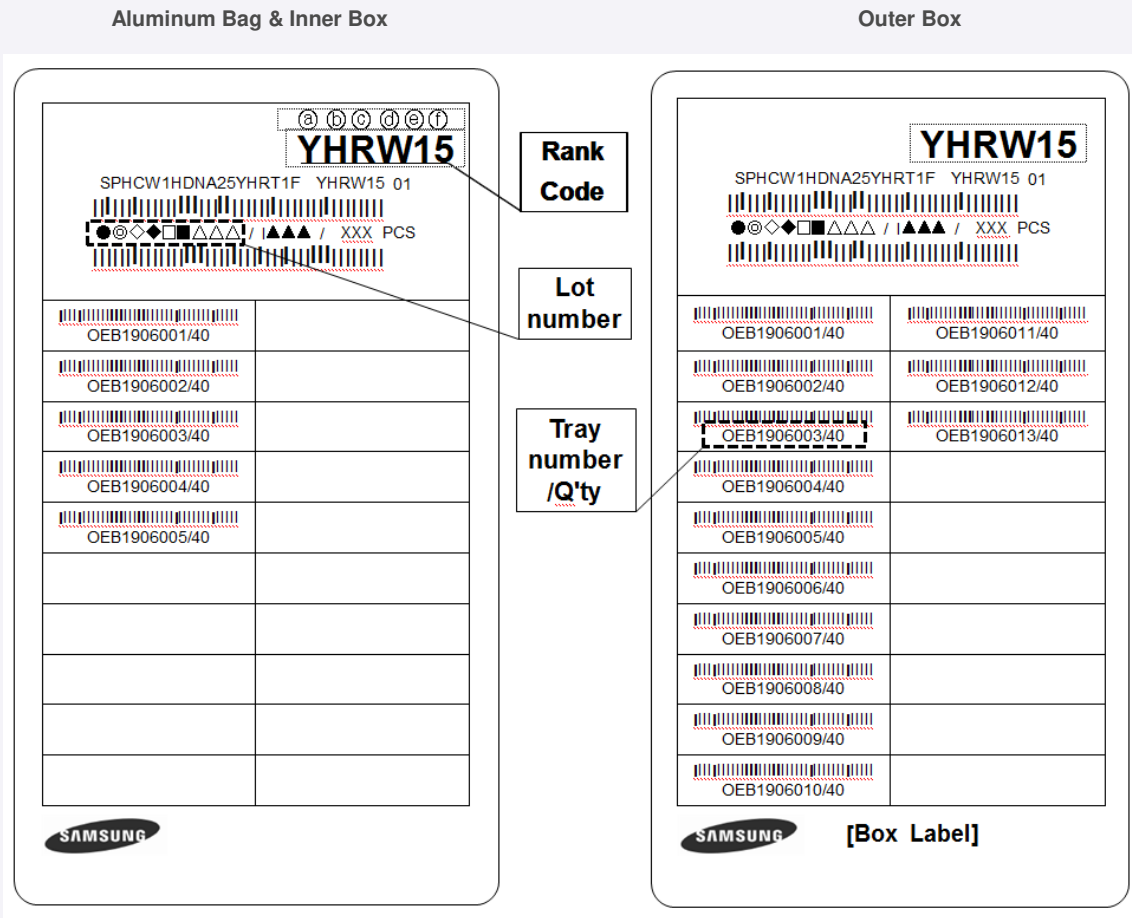

Note: Denoted rank code and product code above is only an example (see description on page 6)

Rank Code:

- ⒶⒷ: Forward Voltage rank (refer to page 7-10)
- ⒸⒹ: Chromaticity bin (refer to page 11-12)
- ⒺⒻ: Luminous Flux bin (refer to page 7-10)

b) Lot Number

The lot number is composed of the following characters:

●◎◇◆□■△△△ / 1▲▲▲ / xxx PCS

- : Production site (S: Korea, G: Tianjin, China)
- ◎ : L (LED)
- ◇ : Product state (A: Normal, B: Bulk, C: First Production, R: Reproduction, S: Sample)
- ◆ : Year (Y: 2014, Z: 2015, A: 2016, ...)
- : Month (1~9, A, B, C)
- : Day (1~9, A, B~V)
- △△△ : Product serial number (001 ~ 009)
- ▲▲▲ : Tray number (001 ~ 999)

7. Packing Structure

Packing material	Max. quantity in pcs of COB	Dimension (mm)			
		Length	Width	Height	Tolerance
Tray	60	322.6	135.9	10.8	1.0
Aluminum Bag	480 (8 trays)	450	230	-	10
PE Foam Pad	-	280	130	10	2
Inner Box	480 (1 aluminum bag)	338	148	55	2
Outer Box	1,920 (4 inner boxes)	351	308	120	5
Pallet	107,520 (56 outer boxes)	1000	1000	130	10

a) Packing Structure

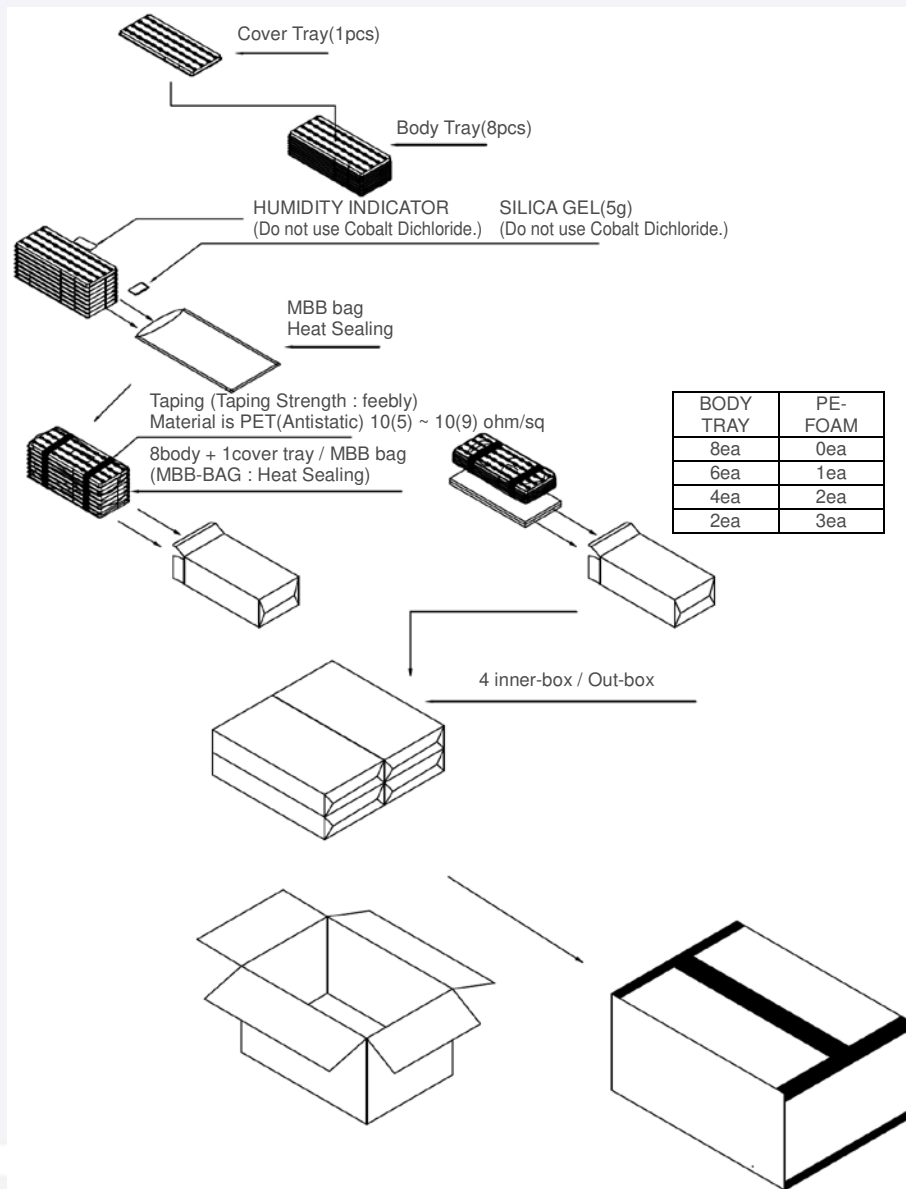

b) Tray

① COVER

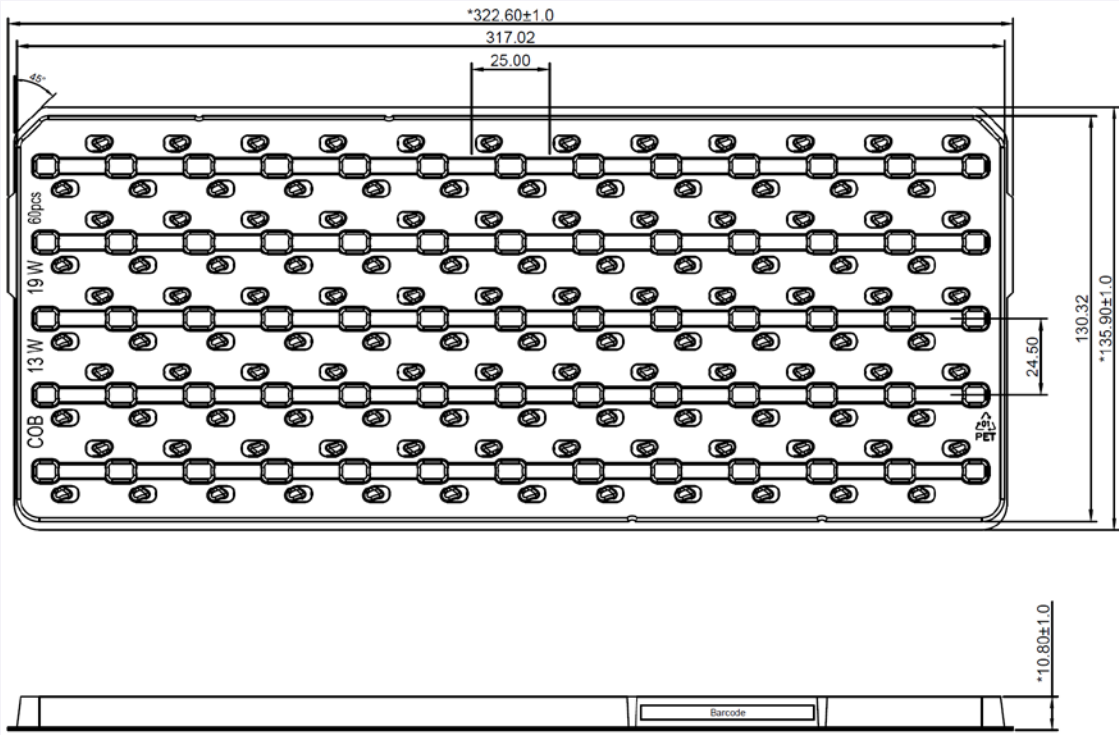

② BODY

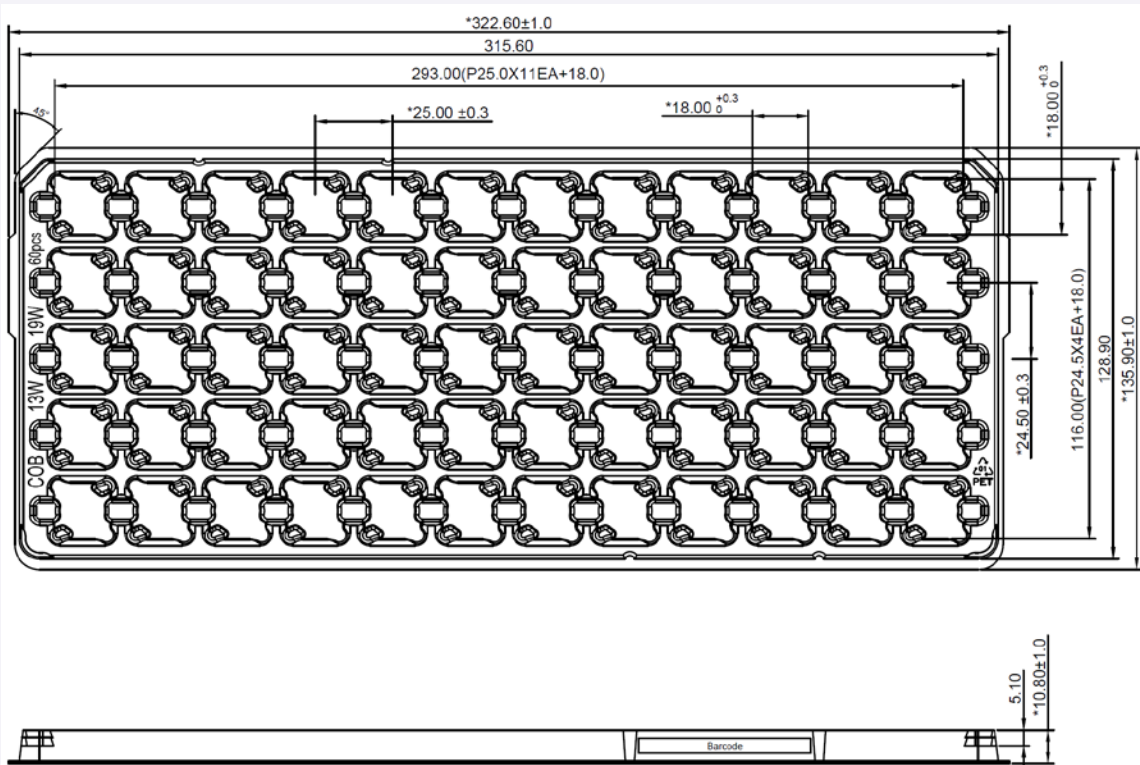

c) Aluminum Vinyl Packing Bag

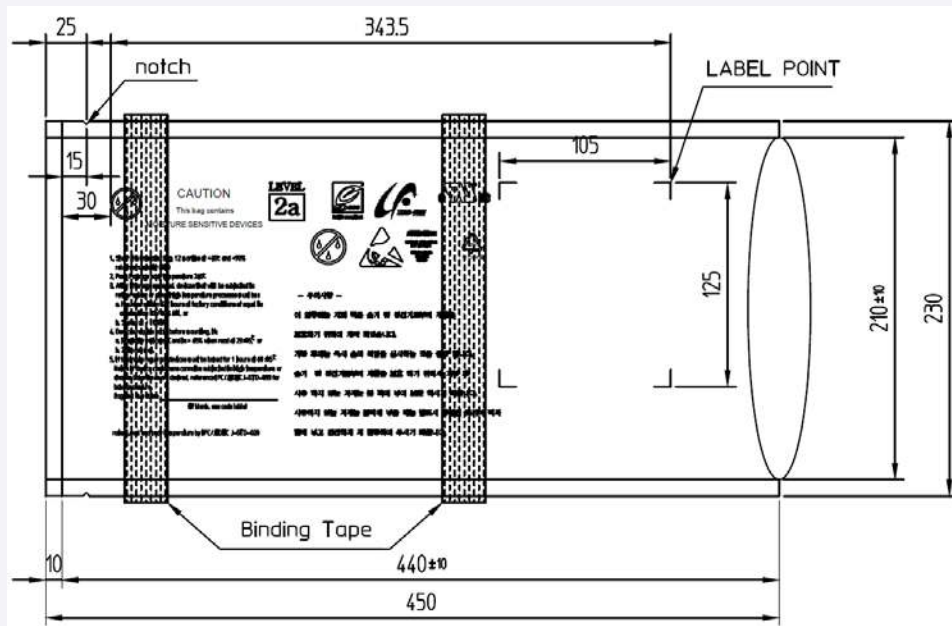

d) Silica Gel & Humidity Indicator Card inside Aluminum Vinyl Packing Bag

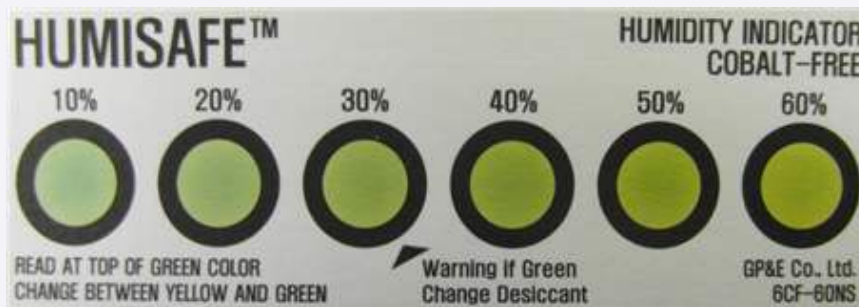

8. Precautions in Handling & Use

- 1) This device should not be used in any type of fluid such as water, oil, organic solvent, etc. When cleaning is required, IPA is recommended as the cleaning agent. Some solvent-based cleaning agent may damage the silicone resins used in the device.
- 2) LEDs must be stored in a clean environment. If the LEDs are to be stored for three months or more after being shipped from Samsung, they should be packed with a nitrogen-filled container (shelf life of sealed bags is 12 months at temperature 0~40 °C, 0~90 % RH).
- 3) After storage bag is opened, device subjected to soldering, solder reflow, or other high temperature processes must be:
 - a. Mounted within 672 hours (28 days) at an assembly line with a condition of no more than 30 °C / 60 % RH, or
 - b. Stored at <10 % RH
- 4) Repack unused products with anti-moisture packing, fold to close any opening and then store in a dry place.
- 5) Devices require baking before mounting, if humidity card reading is >60 % at 23 ± 5 °C.
- 6) Devices must be baked for 1 hour at 60 ± 5 °C, if baking is required.
- 7) The LEDs are sensitive to the static electricity and surge current. It is recommended to use a wrist band or anti-electrostatic glove when handling the LEDs. If voltage exceeding the absolute maximum rating is applied to LEDs, it may cause damage or even destruction to LED devices. Damaged LEDs may show some unusual characteristics such as increase in leakage current, lowered turn-on voltage, or abnormal lighting of LEDs at low current.
- 8) VOCs (Volatile Organic Compounds) can be generated from adhesives, flux, hardener or organic additives used in luminaires (fixtures). Transparent LED silicone encapsulant is permeable to those chemicals and they may lead to a discoloration of encapsulant when they exposed to heat or light. This phenomenon can cause a significant loss of light emitted (output) from the luminaires. In order to prevent these problems, we recommend users to know the physical properties of materials used in luminaires and they must be carefully selected.
- 9) The resin area is very sensitive, please do not handle, press, touch, rub, clean, or pick by with tweezers on it. Instead, please pick at the handling area as indicated below.

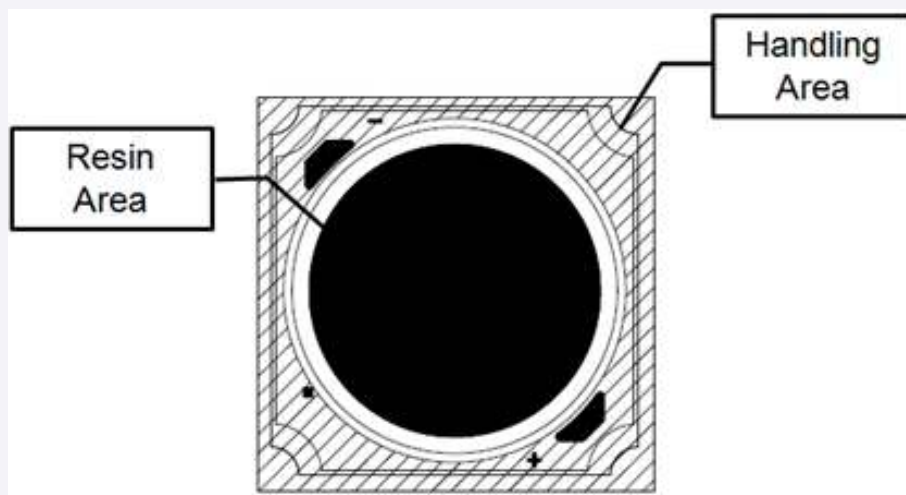

Legal and additional information.

[About Samsung Electronics Co., Ltd.](#)

Samsung Electronics Co., Ltd. inspires the world and shapes the future with transformative ideas and technologies, redefining the worlds of TVs, smartphones, wearable devices, tablets, cameras, digital appliances, printers, medical equipment, network systems and semiconductors.

We are also leading in the Internet of Things space through, among others, our Digital Health and Smart Home initiatives. We employ 307,000 people across 84 countries. To discover more, please visit our official website at www.samsung.com and our official blog at global.samsungtomorrow.com.

Copyright © 2015 Samsung Electronics Co., Ltd. All rights reserved.

Samsung is a registered trademark of Samsung Electronics Co., Ltd.

Specifications and designs are subject to change without notice. Non-metric weights and measurements are approximate. All data were deemed correct at time of creation. Samsung is not liable for errors or omissions. All brand, product, service names and logos are trademarks and/or registered trademarks of their respective owners and are hereby recognized and acknowledged.

Samsung Electronics Co., Ltd.
95, Samsung 2-ro
Giheung-gu
Yongin-si, Gyeonggi-do, 446-711
KOREA

www.samsungled.com

