

TPS61500EVM-369

This user's guide describes the characteristics, operation, and use of the TPS61500EVM-369 evaluation module (EVM). This EVM contains the Texas Instruments TPS61500 boost converter, configured with external components to regulate current through a string of WLEDs. This user's guide includes EVM specifications, recommended test setup, test results, bill of materials, and a schematic diagram.

Contents

1	Introduction	2
1.1	Performance Specification Summary	2
1.2	Modifications.....	2
2	TPS61500EVM-369 Setup	2
2.1	Input/Output Connections.....	2
3	Test Results	4
4	Board Layout	5
5	Schematic and Bill of Materials	9
5.1	TPS61500EVM-369 Schematic	10
5.2	TPS61500EVM-369 Bill of Materials.....	11

List of Figures

1	Efficiency vs. Output Current Using Analog Dimming	4
2	PWM Dimming at $V_{IN} = 5\text{ V}$ (With Optional PWM Dimming Components Q1, Q2, R6 and R9 Installed).....	4
3	Control Loop Response.....	4
4	Assembly Layer including Silk Screen	5
5	Top Copper Layer	6
6	Bottom Copper Layer.....	7
7	Internal Layer 1	8
8	Internal Layer 2	9

List of Tables

1	Typical Performance Specification Summary	2
2	Bill of Materials	11

1 Introduction

The Texas Instruments TPS61500EVM-369 evaluation module contains a TPS61500 boost converter IC, supporting active and passive components, and 5 white light-emitting diodes (WLEDs) in series. The goal of this EVM is to facilitate evaluation of the TPS61500 in a typical WLED application.

1.1 Performance Specification Summary

[Table 1](#) provides a summary of the TPS61500EVM-369 performance specifications. All specifications are given for an ambient temperature of 25°C.

Table 1. Typical Performance Specification Summary

	Conditions	Min	Typ	Max	Units
V_{IN}	JP2 shorted, JP3 shorted	2.9		12	V
	JP2 shorted, JP3 open	4		15	V
V_{OUT}	JP2 shorted, JP3 open		15.5		V
	JP2 shorted, JP3 shorted		12.5		V
I_{WLED}	JP2 shorted	498	513	528	mA
Overvoltage Protection Clamp Voltage	JP2 open		20		V

1.2 Modifications

To aid user customization of the EVM, the board was designed with devices having 0603 or larger footprints. Actual implementations may occupy less space.

2 TPS61500EVM-369 Setup

2.1 Input/Output Connections

The connection points and jumper positions are described in the following paragraphs.

2.1.1 J1 – V_{IN}

This header is the positive connection for the input power supply. The leads to the input supply should be twisted and kept as short as possible. The input voltage should remain within the limits specified in [Table 1](#).

2.1.2 J2 – GND

This header is the return connection to the input power supply.

2.1.3 J3 – V_{OUT}

This header is the positive output of the device.

2.1.4 J4 – GND

This header is the return connection for the load.

2.1.5 J5 – FB

This header is connected to the FB pin of the TPS61500, which is regulated to 0.2 V typical. This point is also connected to the anode of the last WLED in the on-board WLED string.

2.1.6 JP1 – Enable

This jumper connects the enable pin of the TPS61500 to either V_{IN} (enabling the TPS61500) or GND (disabling the TPS61500). The jumper must be installed in one position only. Do not leave JP1 open.

2.1.7 JP2 – Open WLED

Installing this jumper connects the on-board WLED string to the output of the TPS61500. Removing this jumper without connecting the external WLEDs between J3 and J5 simulates the condition of an open WLED and will activate the TPS61500's overvoltage protection circuitry to clamp the output at 20V typical.

2.1.8 JP3 – Short WLED D2

Installing this jumper takes WLED D2 out of the current path on the output and thereby reduces the output power and output voltage. Note that the input voltage range is less in this mode of operation as described in [Table 1](#).

WARNING

This EVM has several WLEDs that shine brightly. Protective eyewear and use of the diffuser cover is recommended.

3 Test Results

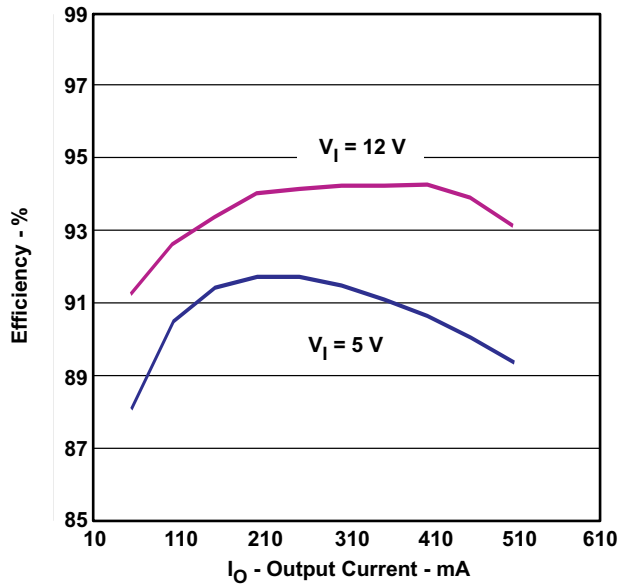

Figure 1. Efficiency vs. Output Current Using Analog Dimming

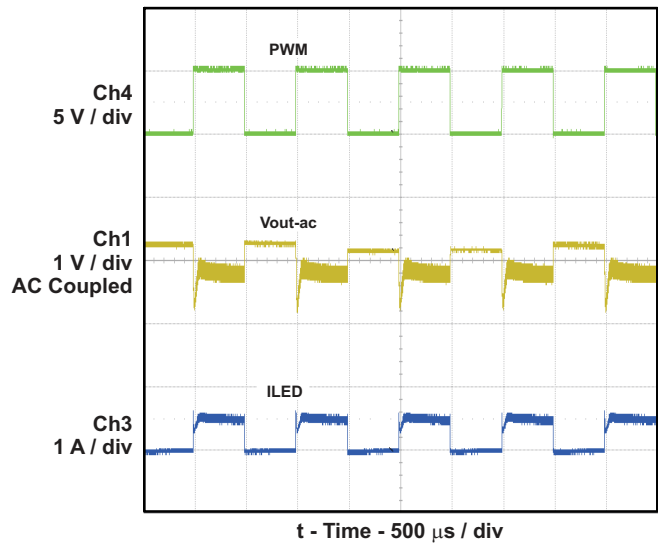

Figure 2. PWM Dimming at $V_{IN} = 5V$ (With Optional PWM Dimming Components Q1, Q2, R6 and R9 Installed)

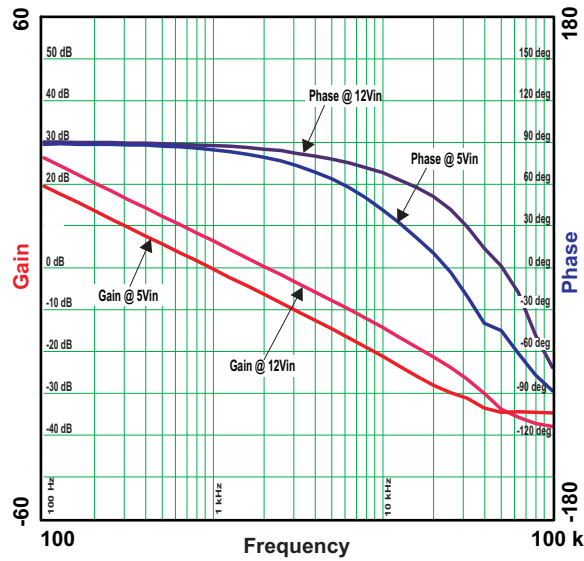

Figure 3. Control Loop Response

4 Board Layout

This section provides the board layout of the TPS61500EVM-369. A 4-layer PCB was used to help with the thermal dissipation of the WLEDs. Even with the low thermal impedance from the WLEDs to the internal layers, the entire PCB acts as a heatsink and so the board and especially the WLEDs get very hot. The user must carefully design their system to handle the thermal challenges raised by the WLEDs.

Board layout is critical for all switch-mode power supplies. See the data sheet ([SLVS893](#)) for specific layout and routing guidelines.

CAUTION
WLEDs are very bright. Protective eye wear is recommended.

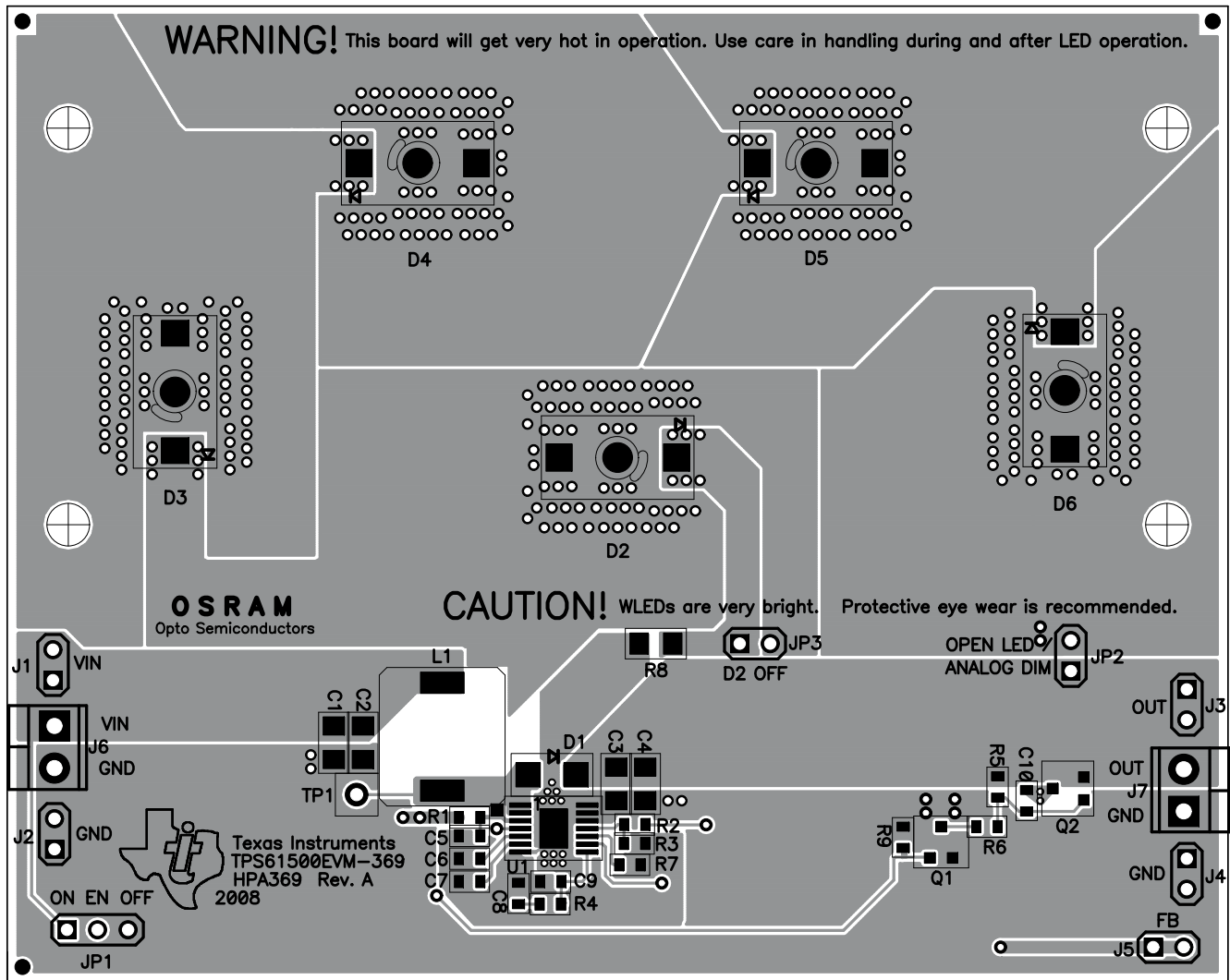

Figure 4. Assembly Layer including Silk Screen

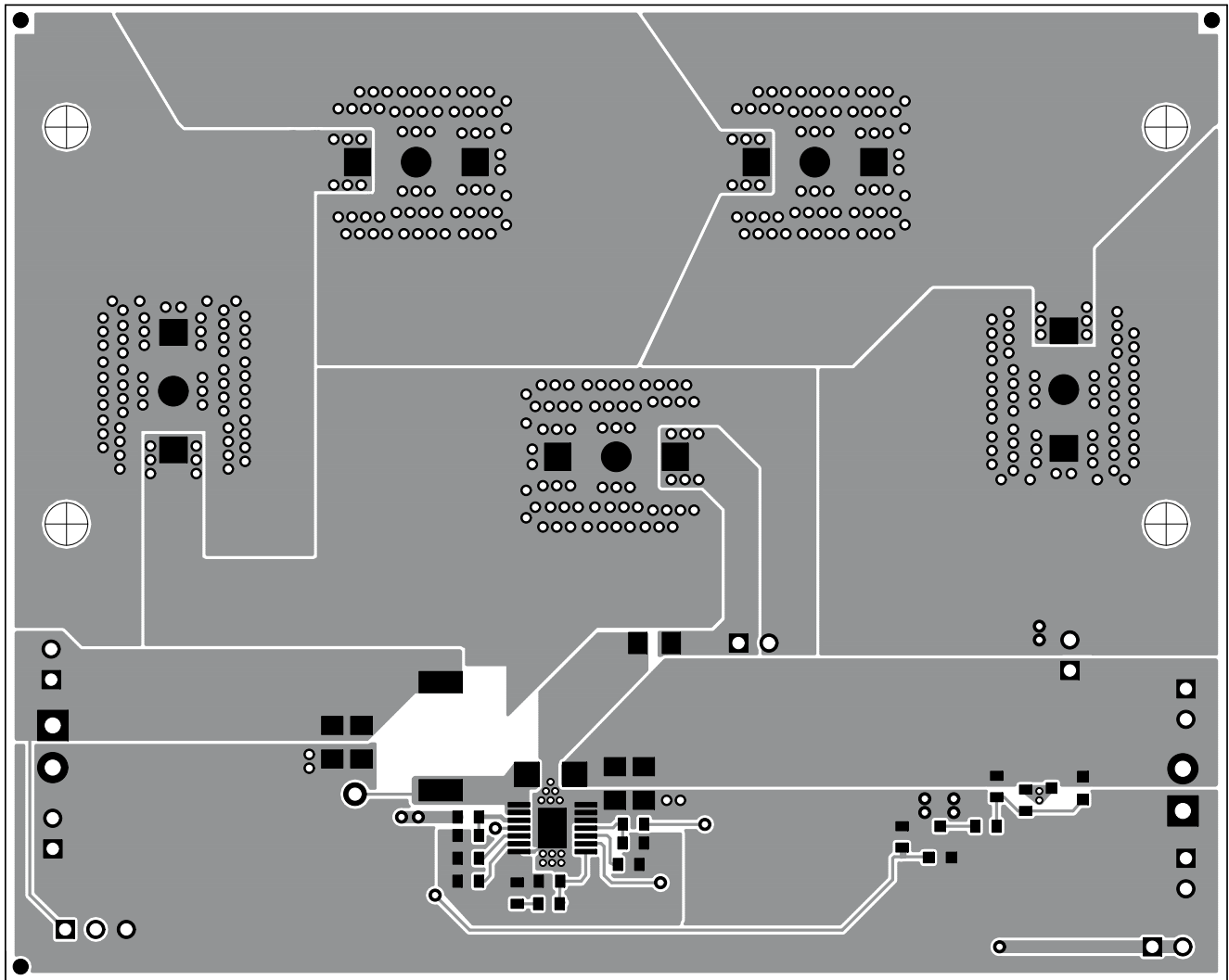

Figure 5. Top Copper Layer

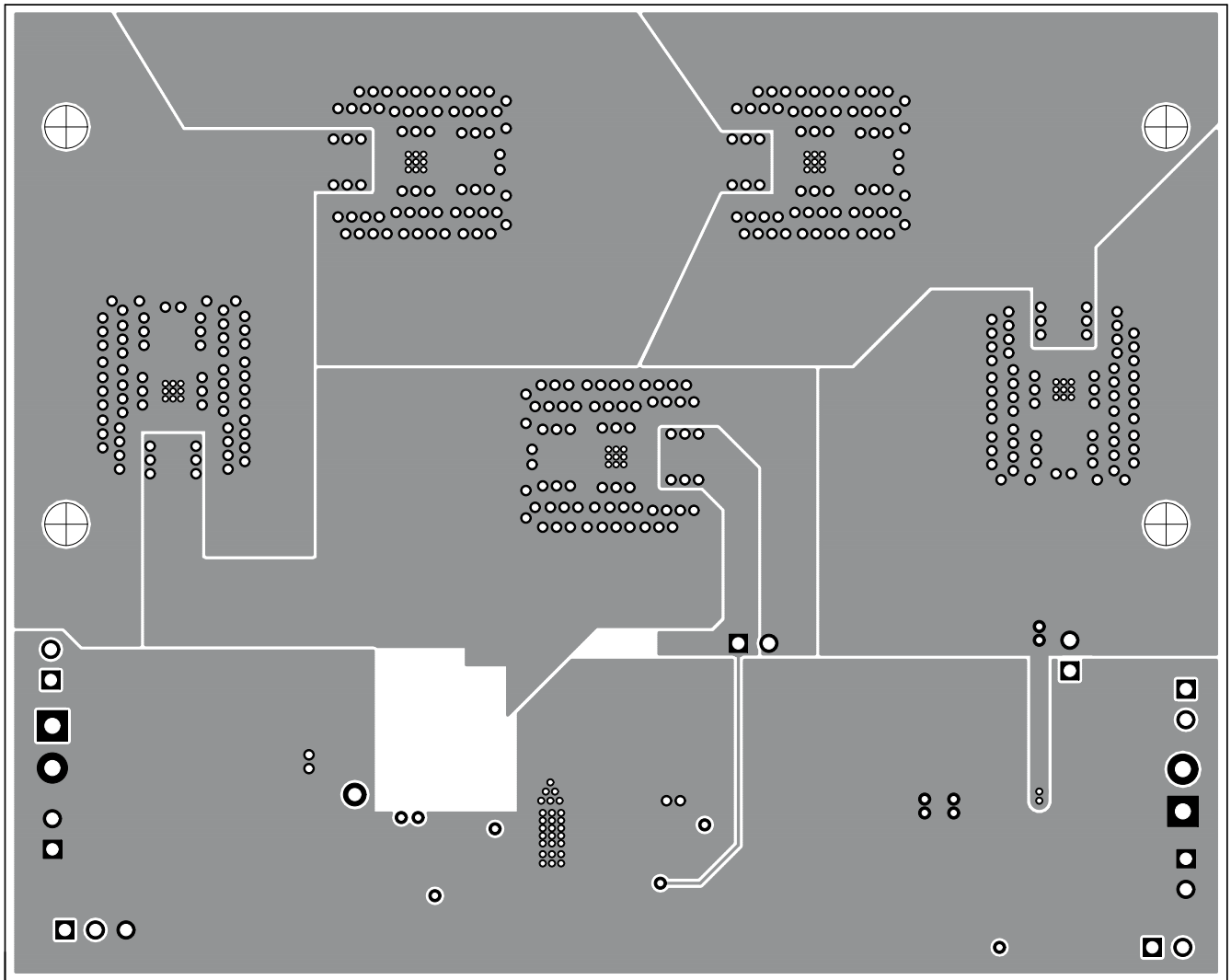

Figure 6. Bottom Copper Layer

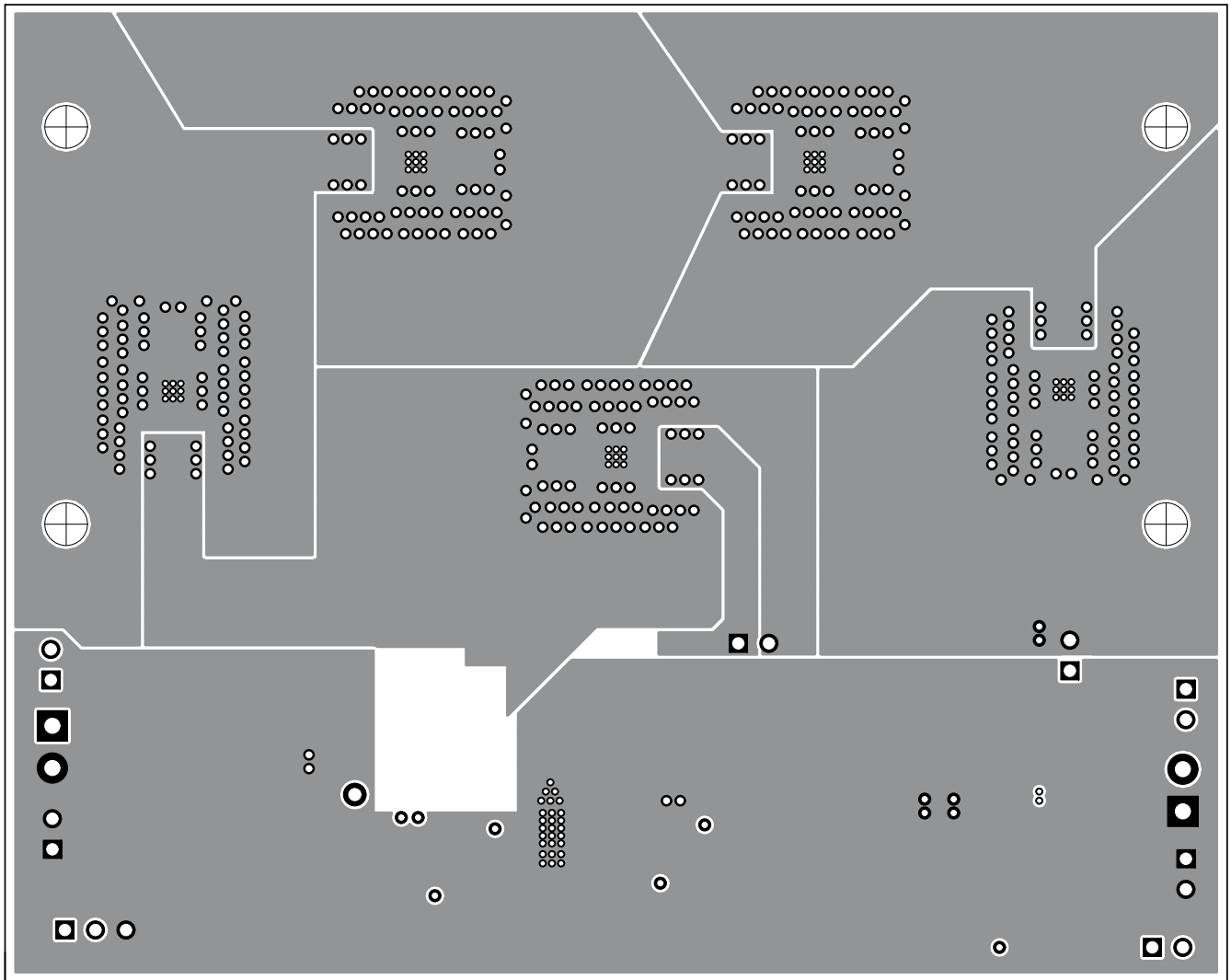

Figure 7. Internal Layer 1

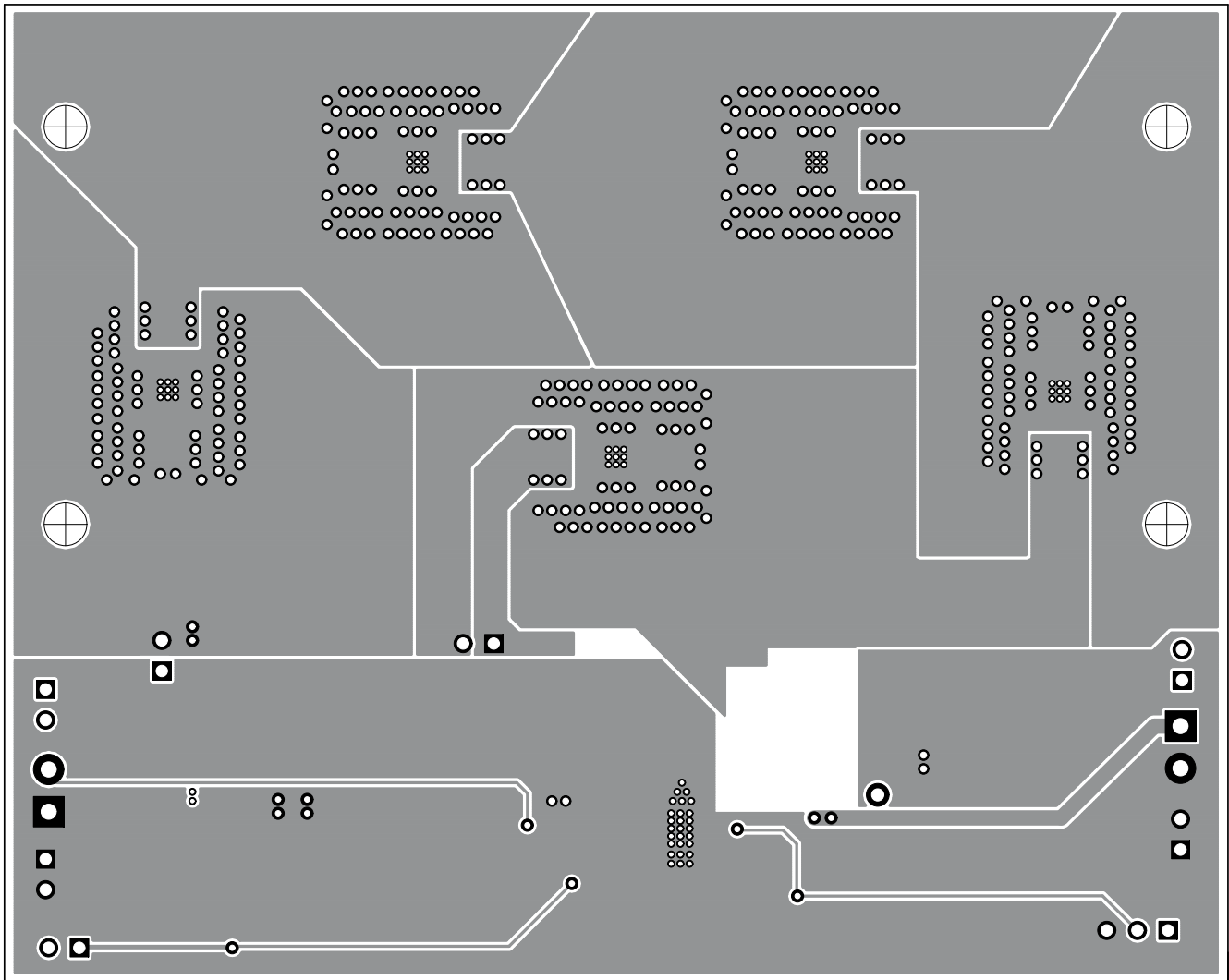
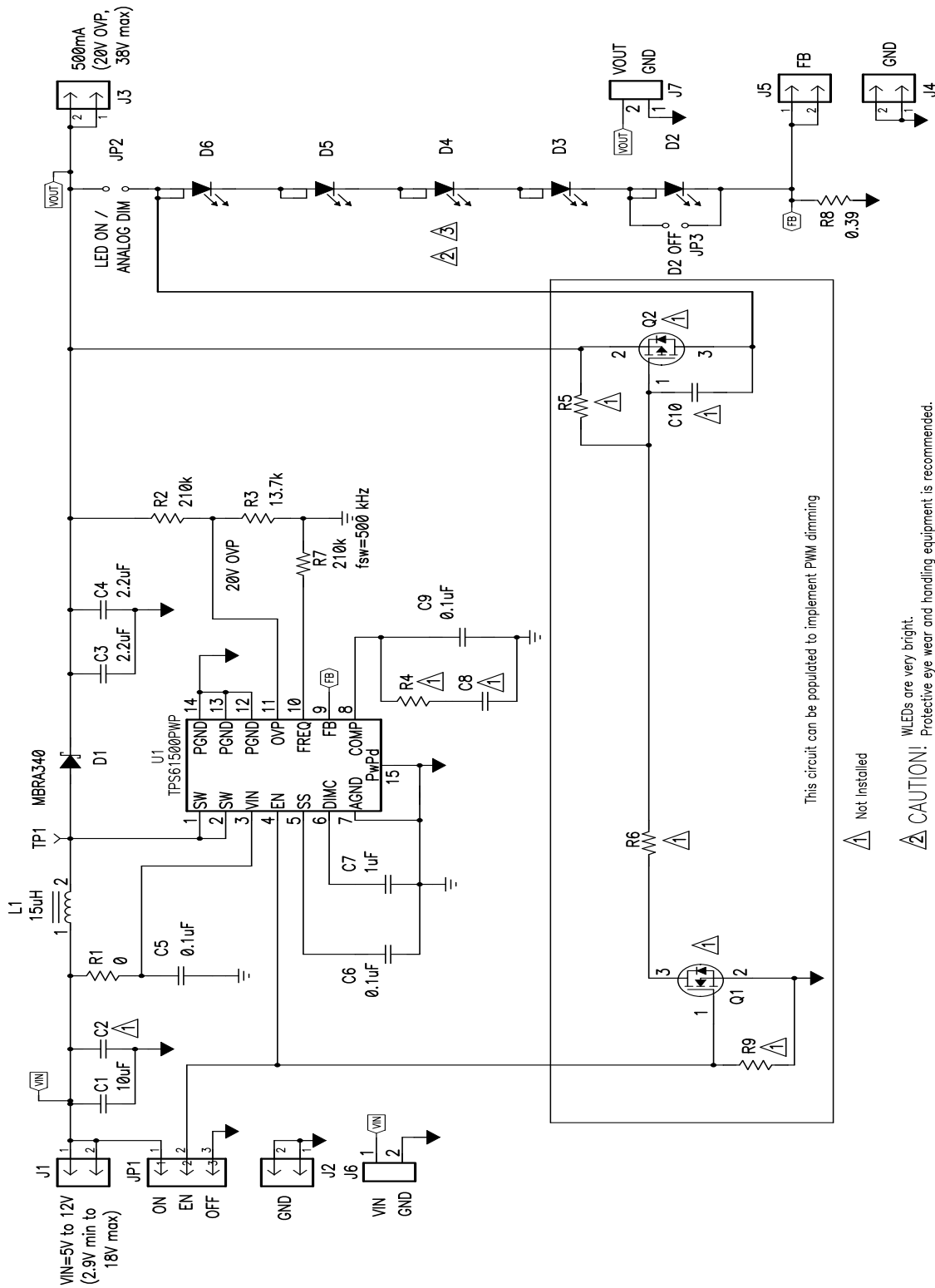

Figure 8. Internal Layer 2

5 Schematic and Bill of Materials

This section contains a schematic and bill of materials for the TPS61500EVM-369.

5.1 TPS61500EVM-369 Schematic



This circuit can be populated to implement PWM dimming

- Not Installed
- CAUTION! WLEDs are very bright. Protective eye wear and handling equipment is recommended.
- WARNING! The WLEDs and PCB will get hot in operation. Take care in handling during and after LED operation.

5.2 TPS61500EVM-369 Bill of Materials
Table 2. Bill of Materials

COUNT	RefDes	Value	Description	Size	Part Number	MFR
1	C1	10uF	Capacitor, Ceramic, 25V, X5R, 20%	1206	STD	STD
0	C2	Open	Capacitor, Ceramic, 25V, X5R, 20%	1206	STD	STD
2	C3, C4	2.2uF	Capacitor, Ceramic, 50V, X5R, 10%	1206	STD	STD
1	C5	0.1uF	Capacitor, Ceramic, 25V, X5R, 20%	0603	STD	STD
2	C6, C9	0.1uF	Capacitor, Ceramic, 10V, X5R, 10%	0603	STD	STD
1	C7	1uF	Capacitor, Ceramic, 10V, X5R, 20%	0603	STD	STD
0	C8, C10	Open	Capacitor, Ceramic, 10V, X5R, 10%	0603	STD	STD
1	D1	MBRA340	Diode, Schottky, 3A, 40V	SMA	MBRA340	On Semi
5	D2, D3, D4, D5, D6	"LW W5SM"	Diode, LED White, 500-mA, 17000-mcd	0.244 x 0.441 inch	LW W5SM	Osram
5	J1, J2, J3, J4, J5	PTC36SAAN	Header, Male 2-pin, 100mil spacing, (36-pin strip)	0.100 inch x 2	PTC36SAAN	Sullins
2	J6, J7	ED1514	Terminal Block, 2-pin, 6-A, 3.5mm	0.27 x 0.25 inch	ED1514	OST
1	JP1	PTC36SAAN	Header, Male 3-pin, 100mil spacing, (36-pin strip)	0.100 inch x 3	PTC36SAAN	Sullins
2	JP2, JP3	PTC36SAAN	Header, 2 pin, 100mil spacing, (36-pin strip)	0.100 inch x 2	PTC36SAAN	Sullins
1	L1	15uH	Inductor, SMT, 3.1A, 42milliohm	0.382 X 0.394 inch	VLF10040T-150M3R1	TDK
0	Q1	Open	MOSFET, N-ch, 60-V, 115-mA, 1.2-Ohms	SOT23	2N7002DICT	Vishay-Liteon
0	Q2	Open	MOSFET, Pch, -40V, 3.0A	SOT-23	SI2319DS	Vishay
1	R1	0	Resistor, Chip, 1/16W, 1%	0603	Std	Std
2	R2, R7	210k	Resistor, Chip, 1/16W, 1%	0603	Std	Std
1	R3	13.7k	Resistor, Chip, 1/16W, 1%	0603	Std	Std
0	R4, R5	Open	Resistor, Chip, 1/16W, 1%	0603	Std	Std
0	R6, R9	1k	Resistor, Chip, 1/16W, 1%	0603	Std	Std
1	R8	0.39	Resistor, Chip, 1/4W, 1%	1206	ERJ-8RQFR39V	Panasonic
1	TP1	5000	Test Point, Red, Thru Hole Color Keyed	0.100 x 0.100 inch	5000	Keystone
1	U1	TPS61500PWP	IC, High Voltage/Current Bosst Converter	HTSSOP-14	TPS61500PWP	TI
1	--		PCB, 4.0" x 3.2" x 0.062"		HPA369	Any
3	--		Shunt, 100-mil, Black	0.100	929950-00	3M
1	--	MCH002	Plexi-glass, smoked	1.7"x 4.0"x 0.125" THK	MCH002	Any
4	--	3464	Aluminum spacer	0.25" tall	3464	Keystone
4	--	PMS 632 0063 SL	Screw, zinc plated steel, pan head slotted	6-32 x 0.625"	PMS 632 0063 SL	Building fasteners
4	--	HNZ632	Hex nut, zinc plated steel	6-32	HNZ632	Building fasteners

EVALUATION BOARD/KIT IMPORTANT NOTICE

Texas Instruments (TI) provides the enclosed product(s) under the following conditions:

This evaluation board/kit is intended for use for **ENGINEERING DEVELOPMENT, DEMONSTRATION, OR EVALUATION PURPOSES ONLY** and is not considered by TI to be a finished end-product fit for general consumer use. Persons handling the product(s) must have electronics training and observe good engineering practice standards. As such, the goods being provided are not intended to be complete in terms of required design-, marketing-, and/or manufacturing-related protective considerations, including product safety and environmental measures typically found in end products that incorporate such semiconductor components or circuit boards. This evaluation board/kit does not fall within the scope of the European Union directives regarding electromagnetic compatibility, restricted substances (RoHS), recycling (WEEE), FCC, CE or UL, and therefore may not meet the technical requirements of these directives or other related directives.

Should this evaluation board/kit not meet the specifications indicated in the User's Guide, the board/kit may be returned within 30 days from the date of delivery for a full refund. **THE FOREGOING WARRANTY IS THE EXCLUSIVE WARRANTY MADE BY SELLER TO BUYER AND IS IN LIEU OF ALL OTHER WARRANTIES, EXPRESSED, IMPLIED, OR STATUTORY, INCLUDING ANY WARRANTY OF MERCHANTABILITY OR FITNESS FOR ANY PARTICULAR PURPOSE.**

The user assumes all responsibility and liability for proper and safe handling of the goods. Further, the user indemnifies TI from all claims arising from the handling or use of the goods. Due to the open construction of the product, it is the user's responsibility to take any and all appropriate precautions with regard to electrostatic discharge.

EXCEPT TO THE EXTENT OF THE INDEMNITY SET FORTH ABOVE, NEITHER PARTY SHALL BE LIABLE TO THE OTHER FOR ANY INDIRECT, SPECIAL, INCIDENTAL, OR CONSEQUENTIAL DAMAGES.

TI currently deals with a variety of customers for products, and therefore our arrangement with the user **is not exclusive**.

TI assumes **no liability for applications assistance, customer product design, software performance, or infringement of patents or services described herein.**

Please read the User's Guide and, specifically, the Warnings and Restrictions notice in the User's Guide prior to handling the product. This notice contains important safety information about temperatures and voltages. For additional information on TI's environmental and/or safety programs, please contact the TI application engineer or visit www.ti.com/esh.

No license is granted under any patent right or other intellectual property right of TI covering or relating to any machine, process, or combination in which such TI products or services might be or are used.

FCC Warning

This evaluation board/kit is intended for use for **ENGINEERING DEVELOPMENT, DEMONSTRATION, OR EVALUATION PURPOSES ONLY** and is not considered by TI to be a finished end-product fit for general consumer use. It generates, uses, and can radiate radio frequency energy and has not been tested for compliance with the limits of computing devices pursuant to part 15 of FCC rules, which are designed to provide reasonable protection against radio frequency interference. Operation of this equipment in other environments may cause interference with radio communications, in which case the user at his own expense will be required to take whatever measures may be required to correct this interference.

EVM WARNINGS AND RESTRICTIONS

It is important to operate this EVM within the input voltage range of 2.9 V to 15 V.

Exceeding the specified input range may cause unexpected operation and/or irreversible damage to the EVM. If there are questions concerning the input range, please contact a TI field representative prior to connecting the input power.

The EVM printed circuit board gets very hot during operation. Use care in handling during and after LED operation. WLEDs are very bright; protective eye wear is recommended.

Applying loads outside of the specified output range may result in unintended operation and/or possible permanent damage to the EVM. Please consult the EVM User's Guide prior to connecting any load to the EVM output. If there is uncertainty as to the load specification, please contact a TI field representative.

During normal operation, some circuit components may have case temperatures greater than 125°C. The EVM is designed to operate properly with certain components above 125°C as long as the input and output ranges are maintained. These components include but are not limited to linear regulators, switching transistors, pass transistors, and current sense resistors. These types of devices can be identified using the EVM schematic located in the EVM User's Guide. When placing measurement probes near these devices during operation, please be aware that these devices may be very warm to the touch.

Mailing Address: Texas Instruments, Post Office Box 655303, Dallas, Texas 75265
Copyright © 2007-2008, Texas Instruments Incorporated

IMPORTANT NOTICE

Texas Instruments Incorporated and its subsidiaries (TI) reserve the right to make corrections, modifications, enhancements, improvements, and other changes to its products and services at any time and to discontinue any product or service without notice. Customers should obtain the latest relevant information before placing orders and should verify that such information is current and complete. All products are sold subject to TI's terms and conditions of sale supplied at the time of order acknowledgment.

TI warrants performance of its hardware products to the specifications applicable at the time of sale in accordance with TI's standard warranty. Testing and other quality control techniques are used to the extent TI deems necessary to support this warranty. Except where mandated by government requirements, testing of all parameters of each product is not necessarily performed.

TI assumes no liability for applications assistance or customer product design. Customers are responsible for their products and applications using TI components. To minimize the risks associated with customer products and applications, customers should provide adequate design and operating safeguards.

TI does not warrant or represent that any license, either express or implied, is granted under any TI patent right, copyright, mask work right, or other TI intellectual property right relating to any combination, machine, or process in which TI products or services are used. Information published by TI regarding third-party products or services does not constitute a license from TI to use such products or services or a warranty or endorsement thereof. Use of such information may require a license from a third party under the patents or other intellectual property of the third party, or a license from TI under the patents or other intellectual property of TI.

Reproduction of TI information in TI data books or data sheets is permissible only if reproduction is without alteration and is accompanied by all associated warranties, conditions, limitations, and notices. Reproduction of this information with alteration is an unfair and deceptive business practice. TI is not responsible or liable for such altered documentation. Information of third parties may be subject to additional restrictions.

Resale of TI products or services with statements different from or beyond the parameters stated by TI for that product or service voids all express and any implied warranties for the associated TI product or service and is an unfair and deceptive business practice. TI is not responsible or liable for any such statements.

TI products are not authorized for use in safety-critical applications (such as life support) where a failure of the TI product would reasonably be expected to cause severe personal injury or death, unless officers of the parties have executed an agreement specifically governing such use. Buyers represent that they have all necessary expertise in the safety and regulatory ramifications of their applications, and acknowledge and agree that they are solely responsible for all legal, regulatory and safety-related requirements concerning their products and any use of TI products in such safety-critical applications, notwithstanding any applications-related information or support that may be provided by TI. Further, Buyers must fully indemnify TI and its representatives against any damages arising out of the use of TI products in such safety-critical applications.

TI products are neither designed nor intended for use in military/aerospace applications or environments unless the TI products are specifically designated by TI as military-grade or "enhanced plastic." Only products designated by TI as military-grade meet military specifications. Buyers acknowledge and agree that any such use of TI products which TI has not designated as military-grade is solely at the Buyer's risk, and that they are solely responsible for compliance with all legal and regulatory requirements in connection with such use.

TI products are neither designed nor intended for use in automotive applications or environments unless the specific TI products are designated by TI as compliant with ISO/TS 16949 requirements. Buyers acknowledge and agree that, if they use any non-designated products in automotive applications, TI will not be responsible for any failure to meet such requirements.

Following are URLs where you can obtain information on other Texas Instruments products and application solutions:

Products

Amplifiers	amplifier.ti.com
Data Converters	dataconverter.ti.com
DLP® Products	www.dlp.com
DSP	dsp.ti.com
Clocks and Timers	www.ti.com/clocks
Interface	interface.ti.com
Logic	logic.ti.com
Power Mgmt	power.ti.com
Microcontrollers	microcontroller.ti.com
RFID	www.ti-rfid.com
RF/IF and ZigBee® Solutions	www.ti.com/lprf

Applications

Audio	www.ti.com/audio
Automotive	www.ti.com/automotive
Broadband	www.ti.com/broadband
Digital Control	www.ti.com/digitalcontrol
Medical	www.ti.com/medical
Military	www.ti.com/military
Optical Networking	www.ti.com/opticalnetwork
Security	www.ti.com/security
Telephony	www.ti.com/telephony
Video & Imaging	www.ti.com/video
Wireless	www.ti.com/wireless

Mailing Address: Texas Instruments, Post Office Box 655303, Dallas, Texas 75265
Copyright © 2009, Texas Instruments Incorporated