

**OMNIMATE Power - series LU**  
**LUFS 15.00/05/90V 5.0SN BK BX**

**Weidmüller Interface GmbH & Co. KG**  
 Klingenbergstraße 16  
 D-32758 Detmold  
 Germany  
 Fon: +49 5231 14-0  
 Fax: +49 5231 14-292083  
 www.weidmueller.com

**Product image**

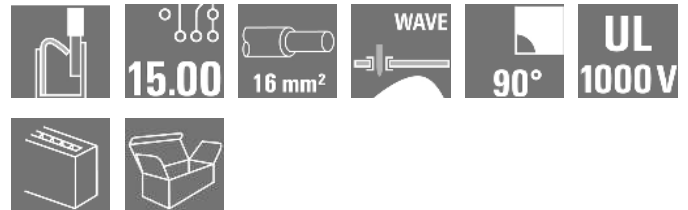

**The sturdy, direct connection for extreme current and voltage requirements in all power electronics applications such as solar inverters, frequency converters, servo-controllers and power supplies.**

**General ordering data**

Type	LUFS 15.00/05/90V 5.0SN BK BX
Order No.	<a href="#">2500590000</a>
Version	Printed circuit board terminals, 15.00 mm, No. of poles: 5, 90°, Solder pin length (l): 5 mm, black, PUSH IN without actuator, Clamping range, max. : 16 mm², Box
GTIN (EAN)	4050118604498
Qty.	20 pc(s).
Product data	IEC: 1000 V / 76 A / 0.5 - 16 mm² UL: 600 V / 53 A / AWG 18 - AWG 4
Packaging	Box

**OMNIMATE Power - series LU**  
**LUFS 15.00/05/90V 5.0SN BK BX**

**Weidmüller Interface GmbH & Co. KG**  
 Klingenbergstraße 16  
 D-32758 Detmold  
 Germany  
 Fon: +49 5231 14-0  
 Fax: +49 5231 14-292083  
 www.weidmueller.com

**Technical data****Dimensions and weights**

Width	71.8 mm	Width (inches)	2.827 inch
Height	35 mm	Height (inches)	1.378 inch
Height of lowest version	30 mm	Depth	28.55 mm
Depth (inches)	1.124 inch	Net weight	58.71 g

**System parameters**

Product family	OMNIMATE Power - series LU	Wire connection method	PUSH IN without actuator
Mounting onto the PCB	THT solder connection	Conductor outlet direction	90°
Pitch in mm (P)	15 mm	Pitch in inches (P)	0.591 inch
No. of poles	5	Fitted by customer	No
Solder pin length (l)	5 mm	Solder pin dimensions	d = 1.2 mm, Octagonal
Solder eyelet hole diameter (D)	1.7 mm	Solder eyelet hole diameter tolerance (D)+	0,1 mm
Number of solder pins per pole	2	Screwdriver blade	0.8 x 4.0
Stripping length	18 mm	L1 in mm	60 mm
L1 in inches	2.362 inch	Touch-safe protection acc. to DIN VDE 0470	IP20 plugged/ IP10 unplugged
Touch-safe protection acc. to DIN VDE 57 106	touch-safe with connected connectors from 6 mm <sup>2</sup>		

**Material data**

Insulating material	Wemid (PA)	Colour code	black
Colour chart (similar)	RAL 9011	Insulating material group	I
CTI	≥ 600	Insulation strength	≥ 10 <sup>8</sup> Ω
UL 94 flammability rating	V-0	Contact material	E-Cu
Storage temperature, min.	-25 °C	Storage temperature, max.	55 °C
Max. relative humidity during storage	80 %	Operating temperature, min.	-40 °C
Operating temperature, max.	120 °C		

**Conductors suitable for connection**

Clamping range, min.	0.5 mm <sup>2</sup>	Clamping range, max.	16 mm <sup>2</sup>
Wire connection cross section AWG, min.	AWG 18	Wire connection cross section AWG, max.	AWG 4
Solid, min. H05(07) V-U	0.5 mm <sup>2</sup>	Solid, max. H05(07) V-U	16 mm <sup>2</sup>
Stranded, min. H07V-R	10 mm <sup>2</sup>	Stranded, max. H07V-R	16 mm <sup>2</sup>
Flexible, min. H05(07) V-K	0.5 mm <sup>2</sup>	Flexible, max. H05(07) V-K	16 mm <sup>2</sup>
w. plastic collar ferrule, DIN 46228 pt 4, min.	0.5 mm <sup>2</sup>	w. plastic collar ferrule, DIN 46228 pt 4, max.	16 mm <sup>2</sup>
w. wire end ferrule, DIN 46228 pt 1, min	0.5 mm <sup>2</sup>	w. wire end ferrule, DIN 46228 pt 1, max.	16 mm <sup>2</sup>

**Rated data acc. to IEC**

Rated current, min. no. of poles (Tu=20°C)	76 A	Rated current, max. no. of poles (Tu=20°C)	76 A
Rated current, min. no. of poles (Tu=40°C)	76 A	Rated current, max. no. of poles (Tu=40°C)	76 A
Rated voltage for surge voltage class / pollution degree II/2	1,000 V	Rated voltage for surge voltage class / pollution degree III/2	1,000 V
Rated voltage for surge voltage class / pollution degree III/3	1,000 V	Rated impulse voltage for surge voltage class/ pollution degree II/2	8 kV
Rated impulse voltage for surge voltage class/ pollution degree III/2	8 kV	Rated impulse voltage for surge voltage class/ contamination degree III/3	8 kV

Creation date February 8, 2019 8:41:30 PM CET

Catalogue status 28.01.2019 / We reserve the right to make technical changes.

## OMNIMATE Power - series LU LUFS 15.00/05/90V 5.0SN BK BX

**Weidmüller Interface GmbH & Co. KG**  
Klingenbergstraße 16  
D-32758 Detmold  
Germany  
Fon: +49 5231 14-0  
Fax: +49 5231 14-292083  
www.weidmueller.com

## Technical data

### Rated data acc. to CSA

Rated voltage (Use group B / CSA)	600 V	Rated voltage (Use group C / CSA)	600 V
Rated voltage (Use group D / CSA)	600 V	Rated current (Use group B / CSA)	53 A
Rated current (Use group C / CSA)	53 A	Rated current (Use group D / CSA)	5 A
Wire cross-section, AWG, min.	AWG 18	Wire cross-section, AWG, max.	AWG 4

### Rated data acc. to UL 1059

Institute (cURus)		Certificate No. (cURus)	E60693
Rated voltage (Use group B / UL 1059)	600 V	Rated voltage (Use group C / UL 1059)	600 V
Rated voltage (Use group D / UL 1059)	600 V	Rated voltage (Use group E / UL 1059)	1,000 V
Rated current (Use group B / UL 1059)	53 A	Rated current (Use group C / UL 1059)	53 A
Rated current (Use group D / UL 1059)	5 A	Rated current (Use group E / UL 1059)	53 A
Wire cross-section, AWG, min.	AWG 18	Wire cross-section, AWG, max.	AWG 4
Reference to approval values	Specifications are maximum values, details - see approval certificate.		

### Packaging

Packaging	Box	VPE length	320 mm
VPE width	170 mm	VPE height	55 mm

### Classifications

ETIM 3.0	EC001284	ETIM 4.0	EC002643
ETIM 5.0	EC002643	ETIM 6.0	EC002643
eClass 6.2	27-26-11-01	eClass 9.1	27-44-04-01

### Notes

Notes	<ul style="list-style-type: none"> <li>• Additional colours on request</li> <li>• Rated current related to rated cross-section &amp; min. No. of poles.</li> <li>• Wire end ferrule without plastic collar to DIN 46228/1</li> <li>• Wire end ferrule with plastic collar to DIN 46228/4</li> <li>• P on drawing = pitch</li> <li>• Rated data refer only to the component itself. Clearance and creepage distances to other components are to be designed in accordance with the relevant application standards.</li> <li>• The test point can only be used as potential-pickup point.</li> </ul>
-------	--

IPC conformity	Conformity: The products are developed, manufactured and delivered according international recognized standards and norms and comply with the assured properties in the data sheet resp. fulfill decorative properties in accordance with IPC-A-610 "Class 2". Further claims on the products can be evaluated on request.
----------------	--

**Data sheet****OMNIMATE Power - series LU**  
**LUFS 15.00/05/90V 5.0SN BK BX****Weidmüller Interface GmbH & Co. KG**  
Klingenbergstraße 16  
D-32758 Detmold  
Germany  
Fon: +49 5231 14-0  
Fax: +49 5231 14-292083  
www.weidmueller.com**Technical data****Approvals**

Approvals

**Downloads**

Approval/Certificate/Document of Conformity	<a href="#">Declaration of the Manufacturer</a>
Engineering Data	<a href="#">STEP</a>
Motion controllers white paper	<a href="#">Download Whitepaper</a>
User Documentation	<a href="#">QR-Code product handling video</a>
White Paper UL 600 V	<a href="#">Download Whitepaper</a>

**OMNIMATE Power - series LU**  
**LUFS 15.00/05/90V 5.0SN BK BX**

**Weidmüller Interface GmbH & Co. KG**  
 Klingenbergstraße 16  
 D-32758 Detmold  
 Germany  
 Fon: +49 5231 14-0  
 Fax: +49 5231 14-292083  
 www.weidmueller.com

Drawings

Dimensional drawing

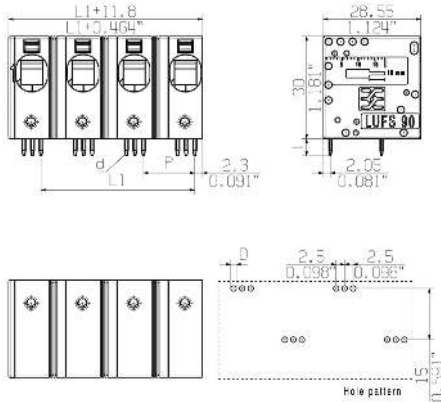

Derating curve

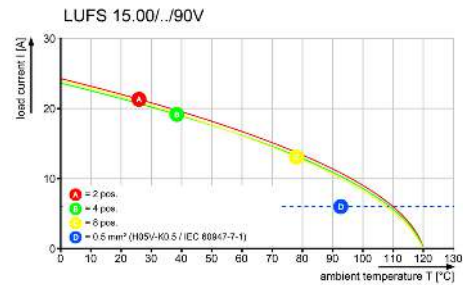

Derating curve

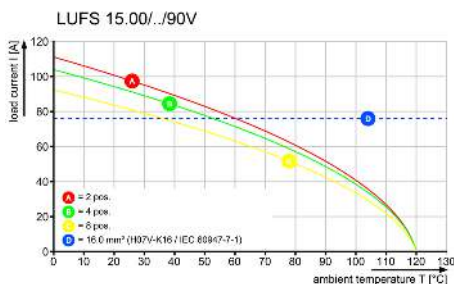

Product benefits



- Power up to UL 600 V
- Offset solder pins

Allgemeinguetliche Kundenzeichnung, aktueller Stand nur auf Anfrage  
 General customer drawing, topical version only if required

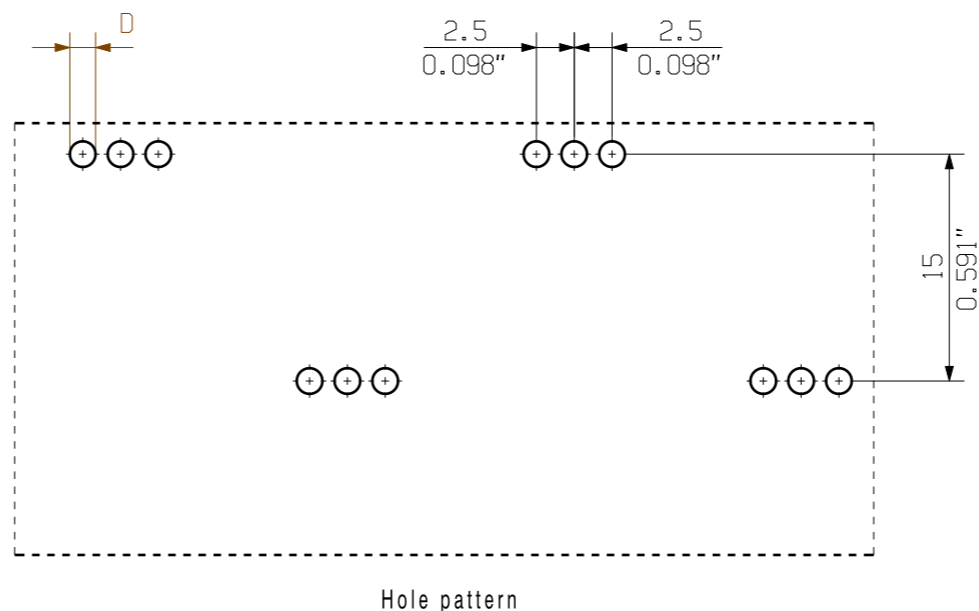
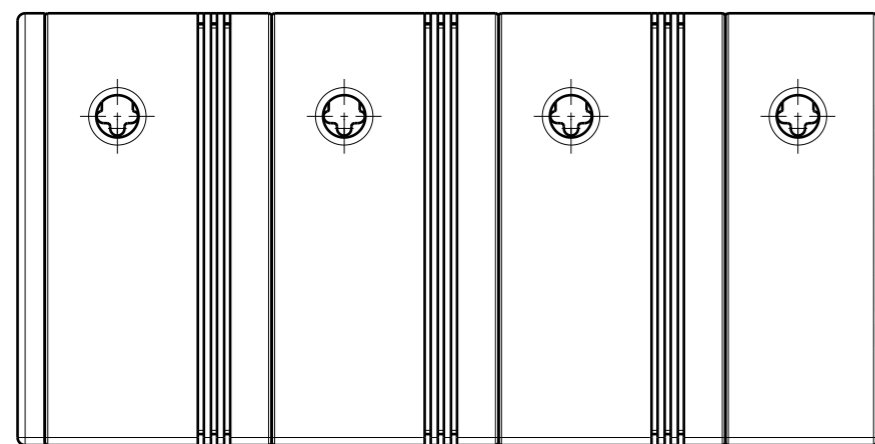
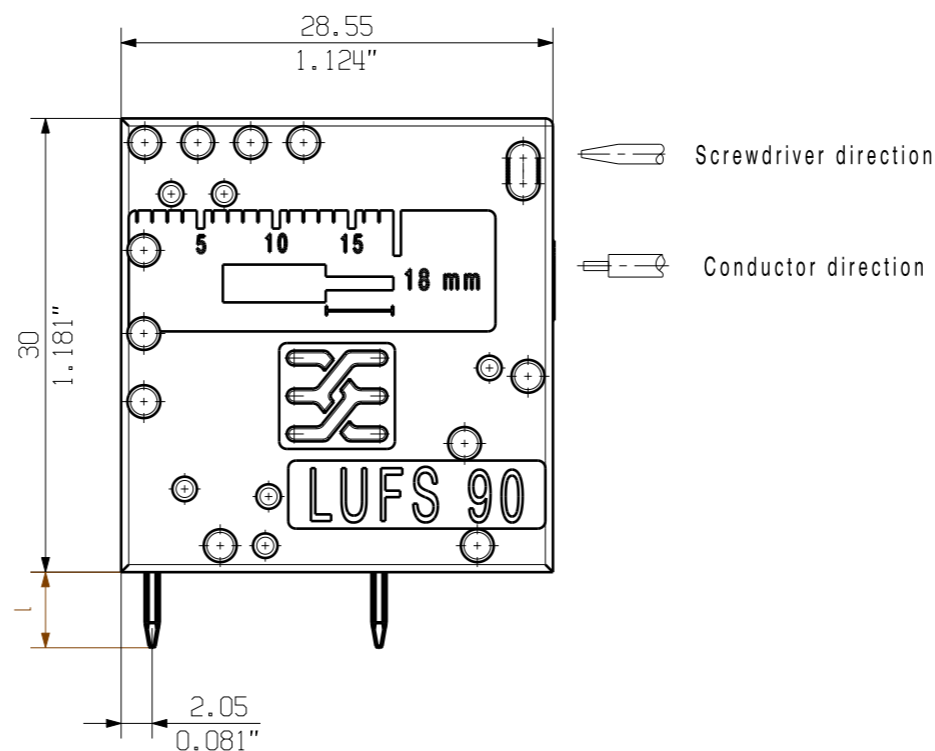
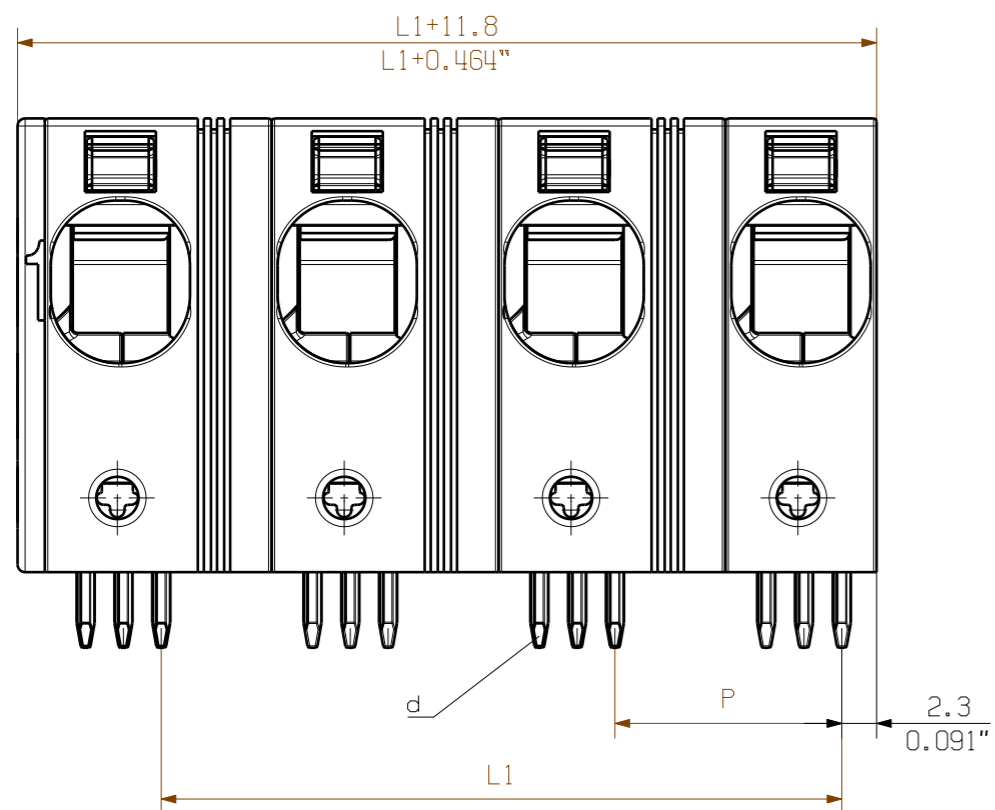

P = 15.00 Pitch  
 0.590" Raster  
 D =  $\varnothing 1.7 + 0.1$   
 0.066"  
 d =  $1.24 \times 1.2$   
 0.049" x 0.047"  
 l = 5.0  
 0.197"

12	165.00	6.496
11	150.00	5.905
10	135.00	5.314
9	120.00	4.724
8	105.00	4.133
7	90.00	3.543
6	75.00	0.952
5	60.00	2.362
4	45.00	1.771
3	30.00	1.181
2	15.00	0.590
n Poles Polzahl	L1 [mm]	L1 [mm]

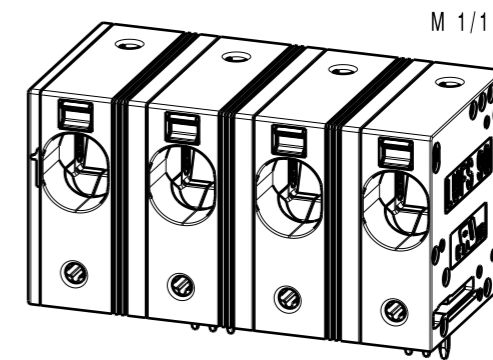

For the mounting of PCBs, it should be noted that the rated data relates only to the PCB components alone.  
 The necessary creepage and clearance paths must be observed in connection with the respective applicant in accordance to IEC 664 / VDE 0110.  
 The current-carrying capacity and pitch tolerance is to be determined according to DIN IEC 326 part 3 very fine.

Weidmüller PCB components are tested to the DIN EN 61984 standard, and are valid for its field of application. Provided that the components are used to the intended purpose, all requirements with respect to the occurring of electrical, mechanical, thermic and corrosive stress will be satisfied.

General tolerance: DIN ISO 2768-mK

95782/3 17.08.17 KRECHT\_M 01

RoHS COMPLIANT

Modification

Drawn	02.12.2016	KRECHT_M
Responsible		SCHMITZ_T
Checked	07.09.2017	HELIS_MA
Approved		NOLTE_S

Scale: 2/1

Supersedes: .

Cat.no.: .

**3 64094 01**

Drawing no. Issue no.  
 Sheet 01 of 01 sheets

**Weidmüller**

**LUFS 15.00/./90**  
 LEITERPLATTENKLEMME  
 PCB TERMINAL

Product file: LUF 10.00

7419

## Recommended wave soldering profiles

**Weidmüller Interface GmbH & Co. KG**  
 Klingenbergstraße 16  
 D-32758 Detmold  
 Germany  
 Fon: +49 5231 14-0  
 Fax: +49 5231 14-292083  
 www.weidmueller.com

### Single Wave:



### Double Wave:

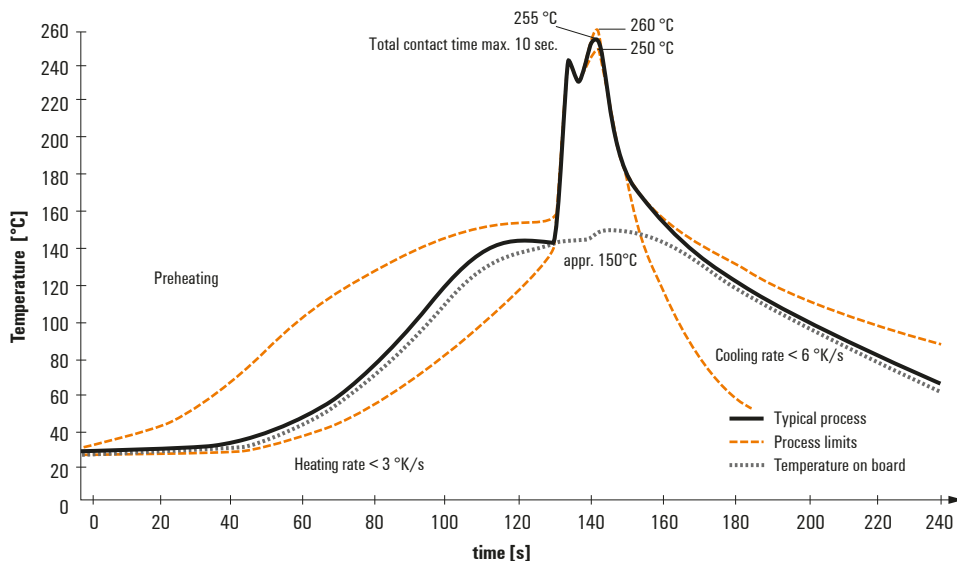

### Wave soldering profiles

Wired connection elements should be processed in accordance with the DIN EN 61760-1 standard. We have included two recommendations for practical wave soldering profiles, with which Weidmüller PCB terminals and connectors are qualified.

When choosing a suitable profile for your application, the following factors also need to be considered:

- PCB thickness
- Proportion of Cu in the layers
- Single/double-sided assembly
- Product range
- Heating and cooling rates

The single and double wave profiles each indicate the recommended operating range, including the maximum soldering temperature of 260°C. In practice, the maximum soldering temperature is quite often well below the above maximum profile.