

1E14E00S

(DRAWING NO.) 台票圖

REFERENCE ONLY



FILED

JUN 30 1999

DOCUMENT CONTROL

版数 REV.	年月日 DATE	図号 DCN NO.	変更内容 DESCRIPTION	製図 DR.	担当 CHK.	査閲 APPD.	承認 APPD.

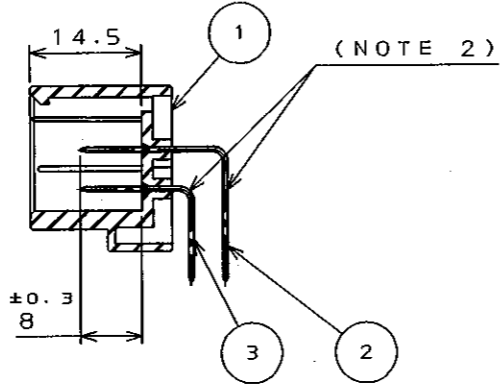
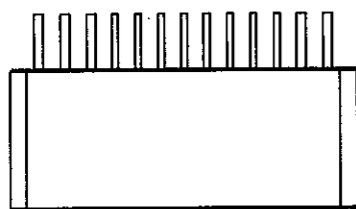
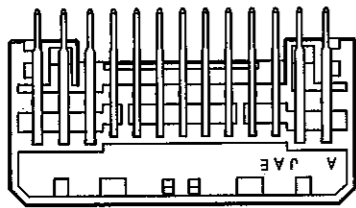

SECT. A-A

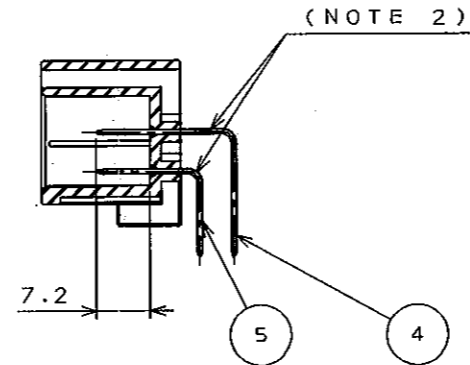

SECT. B-B

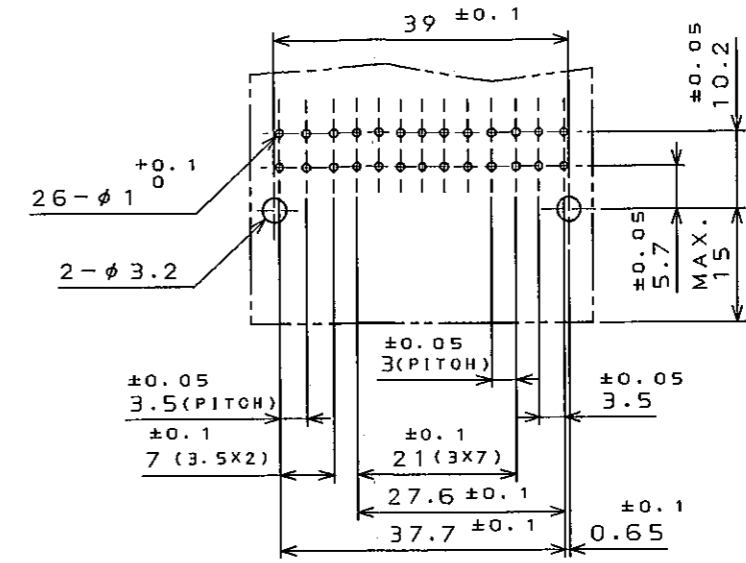

APPLICABLE P.C.B. DIMENSION (REF.)
適合基板寸法

THICKNESS t1.6 ±0.15

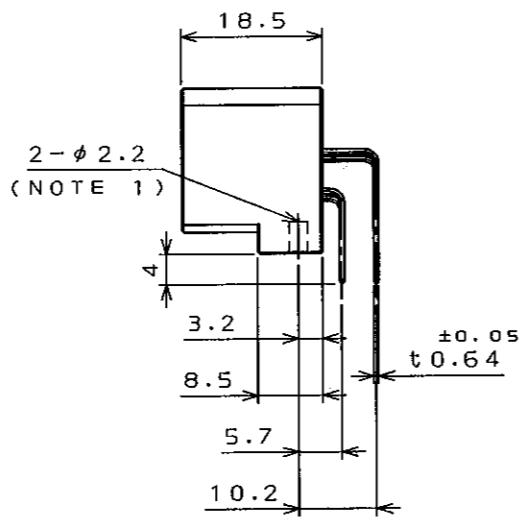
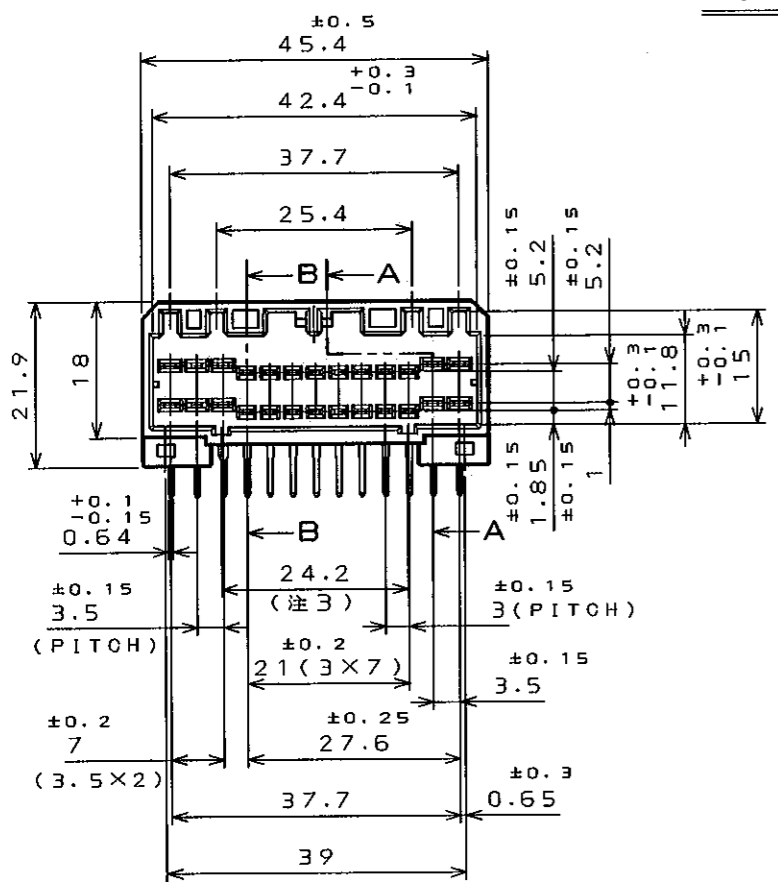

- NOTE 1. RECOMMENDED SCREW IS JIS B 1115, 1122 OR 1123. M3X6 LENGTH TAPPING SCREW 2 OR 4.
- NOTE 2. THE SHEARED EDGES OF Sn PLATED CONTACTS ARE NOT PLATED.
- NOTE 3. DIMENSION 24.2 MEANS DISTANCE BETWEEN TWO GROOVES CENTER.

- 注1. 推奨取り付けネジ: JIS B 1115, 1122又は1123 M3X6 タッピンネジ 2種又は4種.
- 注2. スズメッキコンタクトの破断面には、メッキはつかない.
- 注3. 寸法24.2は、各下部キー溝の中心間の寸法である.

符号 NO.	名称 DESCRIPTION	個数 QTY.	材料 MATERIAL	仕上 FINISH	備考 REMARKS
5	PIN CONTACT #4	8	BRASS	Sn PLATING	SIGNAL
4	PIN CONTACT #3	8	BRASS	Sn PLATING	SIGNAL
3	PIN CONTACT #2	5	BRASS	Sn PLATING	POWER
2	PIN CONTACT #1	5	BRASS	Sn PLATING	POWER
1	PIN INSULATOR	1	GLASS FILLED PBT		COLOR: GREEN

仕様書 (SPECIFICATION)		第1版 (ORIGINAL DATE)		尺度 (SCALE)	シリーズ (SERIES)	日本航空電子工業株式会社 JAPAN AVIATION ELECTRONICS INDUSTRY, LTD.
JACS-1374 (J AHL-1374)		15.Apr.1999		1:1	MX5	
一般公差 (GENERAL TOLERANCE)		製図 DR.	名称 (TITLE)		MX5-26P-L-G	図面番号 (DRAWING NO.) SJ034131
寸法 (DIMENSION)		担当 CHK.	重量 (WEIGHT)			
. ±0.5		査閲 APPD.	K.HASEBE			
.X ±0.3		承認 APPD.	T.KUME			
.XX ±		承認 APPD.	Y.ICHIYAMA		版数 (REV.)	1
.XXX ±		角度 (ANGLES)				
. ±		X° ±				
.X ±		X°X' ±				
.XXX ±						

本図面は日本航空電子工業(株)の所有する情報を含むもので当社の許可なく複製を禁止する。

CDS-99-110-50204

SIZE A3

DCF-C-2120(98.02)