



## Quick Start Guide

# OM2NTA5KIT

Exploring the exclusive features of NTAG 5 switch,  
NTAG 5 link and NTAG 5 boost

NTAG 5 FAMILY - DEMOBOARDS



## GET TO KNOW THE NTAG 5 switch board

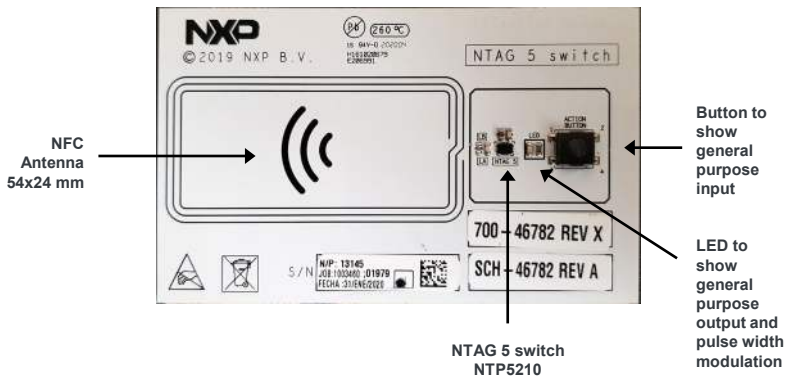

Front side of NTAG 5 switch demo board

## NTAG 5 switch board schematics

### NTAG 5 switch

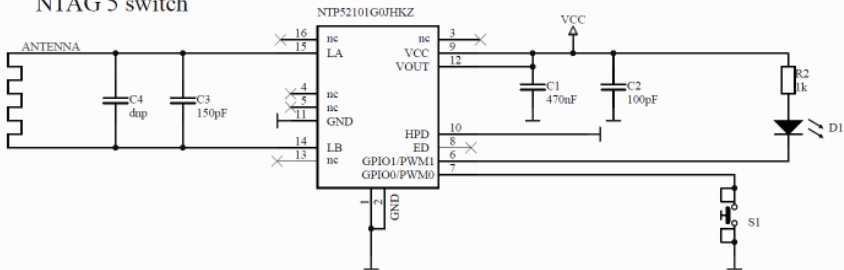

## GET TO KNOW THE NTAG 5 link board



Front side of NTAG 5 link demo board



## GET TO KNOW THE NTAG 5 boost board

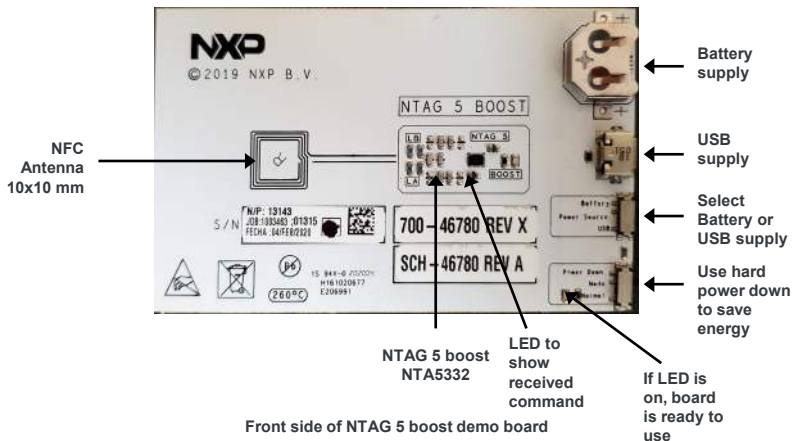

## NTAG 5 boost board schematics

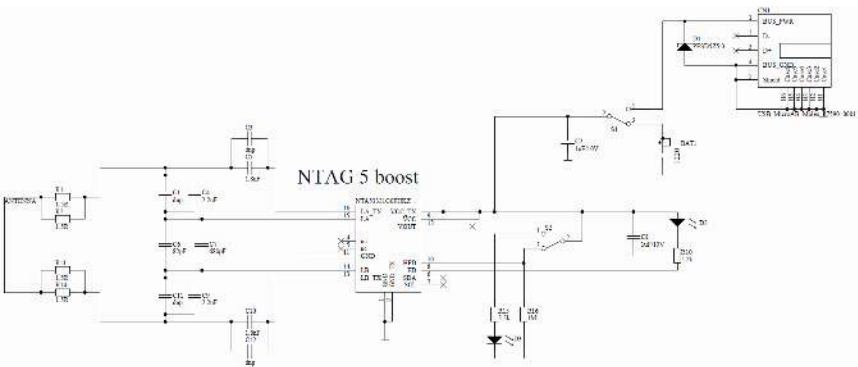



When no board is connected, status switches to "polling"



NTAG 5 show card tab



Use side  
menu to  
navigate

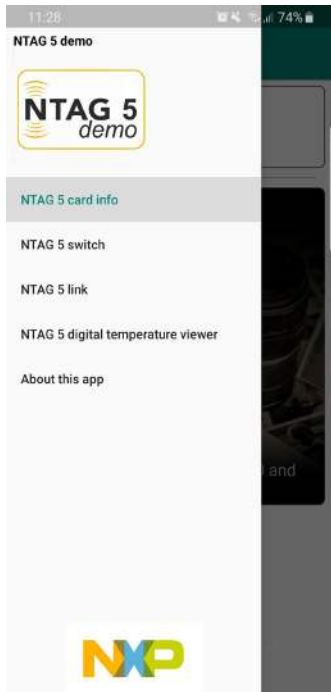

NTAG 5 demo navigation



← When button is pressed, bulb goes on

→ When board is connected, status switches to "activated"

← Explore GPO and PWM

NTAG 5 switch general purpose input

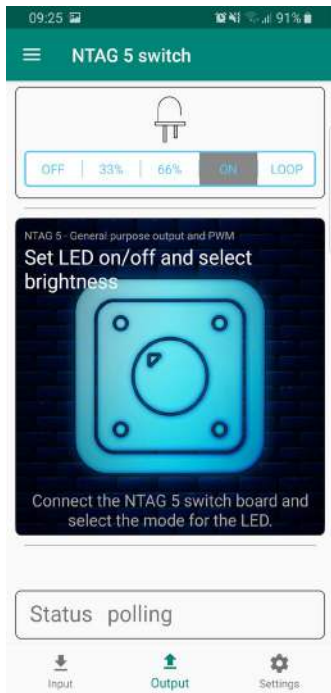

Change settings of LED brightness

When board is connected, status switches to "activated"

Explore GPIO or change loop speed

NTAG 5 switch general purpose output and pulse width modulation



← Configure how fast brightness changes

← Explore GPIO and PWM features

NTAG 5 switch settings

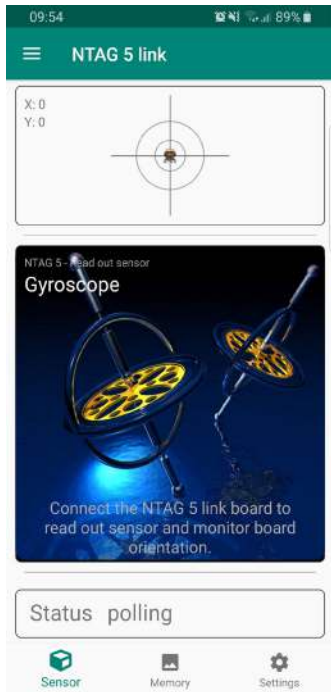

X and Y orientation of 6 axis sensor



When board is connected, status switches to "activated"



Explore memory extension or configure output voltage



NTAG 5 link read sensor

Image read from FRAM will be displayed

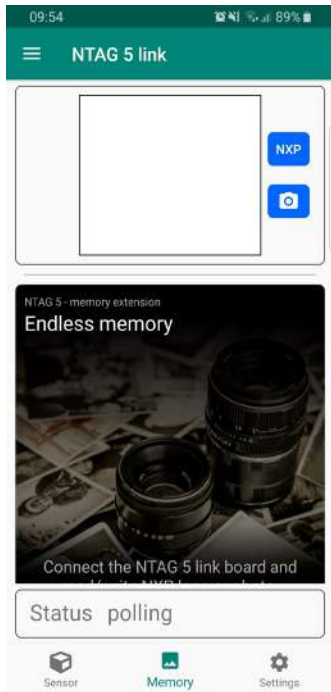

Write NXP logo or photo from camera to FRAM



When board is connected, status switches to "activated"



Explore sensor tag or configure output voltage



NTAG 5 link extend user memory

Image read from FRAM will be displayed



Change output voltage. You need to re-connect the board afterwards to make settings



When board is connected, status switches to "activated"



Explore sensor tag or memory extension



NTAG 5 link set output voltage

### NTAG 5 switch FEATURES

- ISO/IEC 15693 compliant
- NFC Forum Type 5 Tag compliant
- General Purpose Input and Output (GPIO)
- Pulse Width Modulation (PWM)
- Regulated Energy Harvesting
- 512 byte user memory
- Up to three configurable memory areas
- 32 or 64-bit password protection
- ECC based reprogrammable originality signature

### On top NTAG 5 link FEATURES

- I<sup>2</sup>C master and slave up to 400 kHz
- 2048 byte user memory
- 256 byte SRAM
- AES mutual authentication

### On top NTAG 5 boost FEATURE

- Active Load Modulation

### STEP-BY-STEP INSTRUCTIONS

#### 1 Install App



Install NTAG 5 demo app from Google Play Store or Apple App Store

#### 2 Switch on NFC on mobile phone

In the settings menu of your NFC enabled mobile phone



## STEP-BY-STEP INSTRUCTIONS (cont.)

### 3 Explore NTAG 5 switch demo board

Make sure status is “activated”  
Press button on board to explore GPIO functionality  
Select ON/PWM/OFF to explore GPIO and PWM functionality  
Change brightness of LED in a loop

### 4 Explore NTAG 5 link demo board

Make sure status is “activated”  
Move board with phone to see X/Y orientation  
Write/read photo to/from the FRAM  
NOTE: FRAM is not initialized. Writing the NXP logo or a photo to the FRAM should be the first step  
Change Energy harvesting voltage

### 5 Explore read range of boards

Status changes from “polling” to “activated” as soon board is detected

### 6 Curious? Order our Development board

On NTAG 5 customer development board web page you will find all documentation, source files and the boards itself

## SUPPORT

Visit [www.nxp.com/support](http://www.nxp.com/support) for a list of phonenumber within your region.

## WARRANTY

Visit [www.nxp.com/warranty](http://www.nxp.com/warranty) for complete warranty information.



## Get Started

Download installation software and documentation

**“Jump Start Your Design”** at  
[nxp.com/demoboard/OM2NTx5332](http://nxp.com/demoboard/OM2NTx5332)

[www.nxp.com](http://www.nxp.com)

NXP and the NXP logo are trademarks of NXP B.V. All other product or service names are the property of their respective owners. © 2016 NXP B.V.