

### Features

- Ideal for indication light on hand held products
- Long life and robust package
- Standard Package: 2,000pcs/ Reel
- MSL (Moisture Sensitivity Level): 3
- RoHS compliant



**ATTENTION**  
OBSERVE PRECAUTIONS  
FOR HANDLING  
ELECTROSTATIC  
DISCHARGE  
SENSITIVE  
DEVICES

### Package Schematics

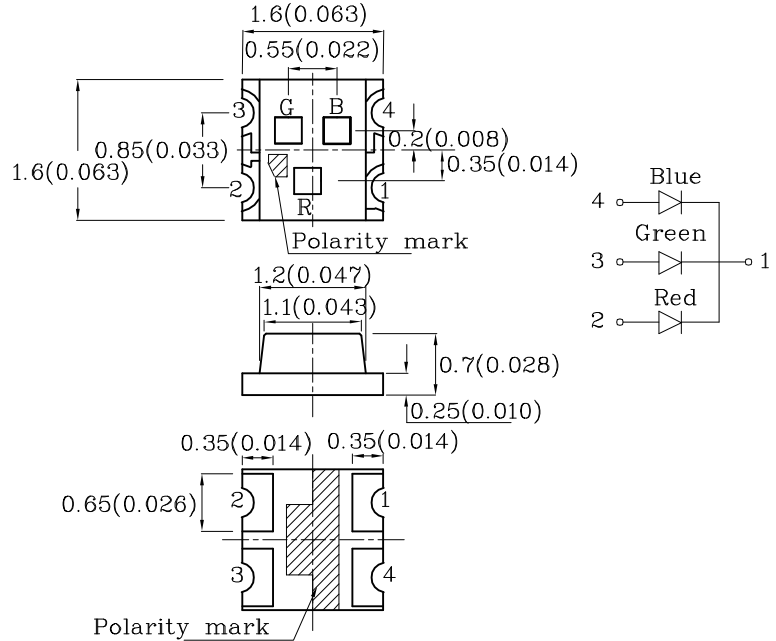

#### Notes:

1. All dimensions are in millimeters (inches).
2. Tolerance is  $\pm 0.2(0.008)$  unless otherwise noted.
3. Specifications are subject to change without notice.

Absolute Maximum Ratings ( $T_A=25^\circ\text{C}$ )		Red (AlGaIn P)	Green (InGa N)	Blue (InGa N)	Unit	Operating Characteristics ( $T_A=25^\circ\text{C}$ )		Red (AlGaIn P)	Green (InGa N)	Blue (InGa N)	Unit
Reverse Voltage	$V_R$	5	5	5	V	Forward Voltage (Typ.) ( $I_F=20\text{mA}$ )	$V_F$	2.2	3.2	3.3	V
Forward Current	$I_F$	30	30	30	mA	Forward Voltage (Max.) ( $I_F=20\text{mA}$ )	$V_F$	2.8	4	4	V
Forward Current (Peak) 1/10 Duty Cycle 0.1ms Pulse Width	$i_{FS}$	150	100	100	mA	Reverse Current (Max.) ( $V_R=5\text{V}$ )	$I_R$	10	50	50	$\mu\text{A}$
Power Dissipation	$P_D$	84	120	120	mW	Wavelength of Peak Emission CIE127-2007* (Typ.) ( $I_F=20\text{mA}$ )	$\lambda_P$	640*	520*	465*	nm
Electrostatic Discharge Threshold (HBM)		3000	450	250	V	Wavelength of Dominant Emission CIE127-2007* (Typ.) ( $I_F=20\text{mA}$ )	$\lambda_D$	625*	525*	470*	nm
Operating Temperature	$T_A$	-40 ~ +85			$^\circ\text{C}$	Spectral Line Full Width At Half-Maximum (Typ.) ( $I_F=20\text{mA}$ )	$\Delta\lambda$	25	35	22	nm
Storage Temperature	$T_{stg}$					Capacitance (Typ.) ( $V_F=0\text{V}$ , $f=1\text{MHz}$ )	C	27	100	100	pF

A Relative Humidity between 40% and 60% is recommended in ESD-protected work areas to reduce static build up during assembly process (Reference JEDEC/JESD625-A and JEDEC/J-STD-033)

Part Number	Emitting Color	Emitting Material	Lens-color	Luminous Intensity CIE127-2007* ( $I_F=20\text{mA}$ )mcd		Wavelength CIE127-2007* nm $\lambda_P$	Viewing Angle 2 $\theta$ 1/2
				min.	typ.		
XZM2ACRM2DGFBB110W	Red	AlGaInP	Water Clear	200*	357*	640*	130°
	Green	InGaN		500*	745*	520*	
	Blue	InGaN		80*	138*	465*	

\*Luminous intensity value and wavelength are in accordance with CIE127-2007 standards.  
Oct 23, 2018

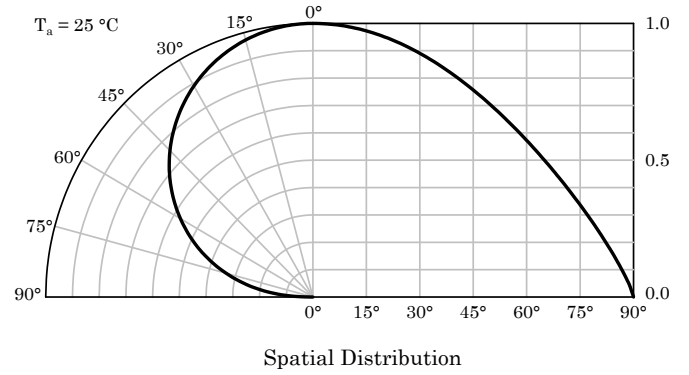
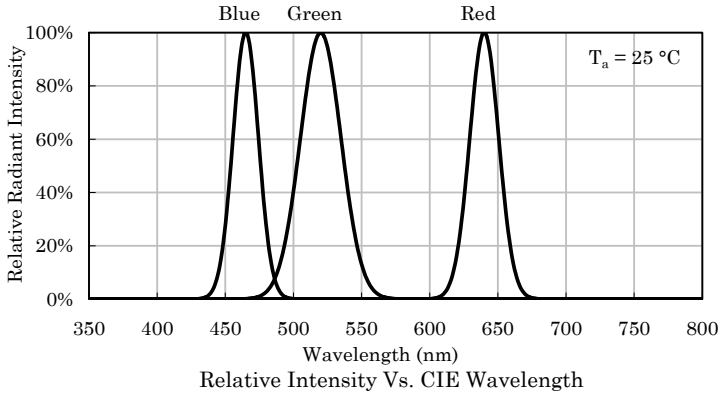

◆ Red

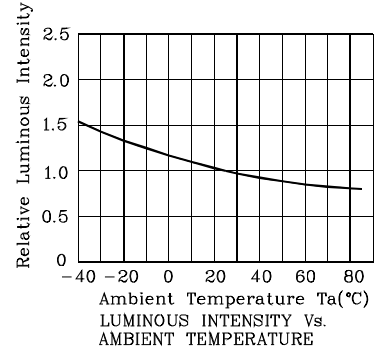
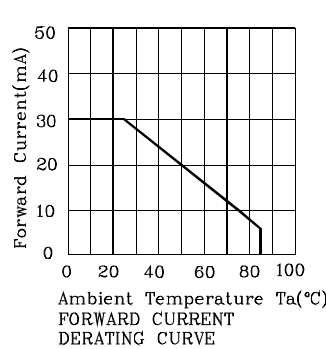
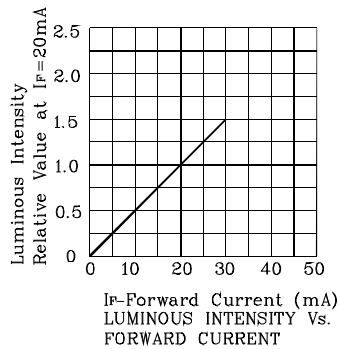
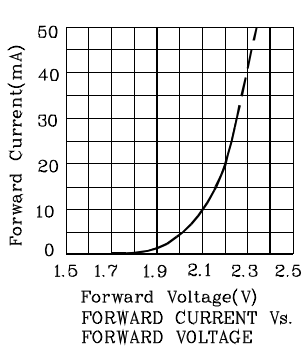

◆ Green

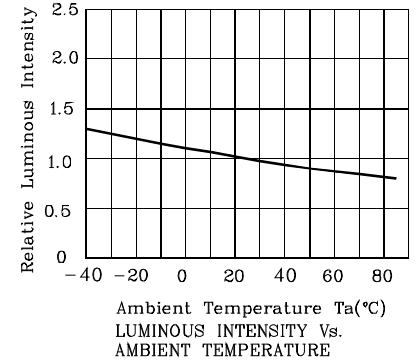
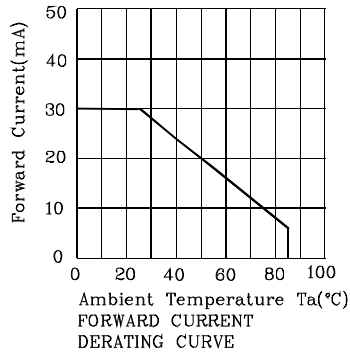
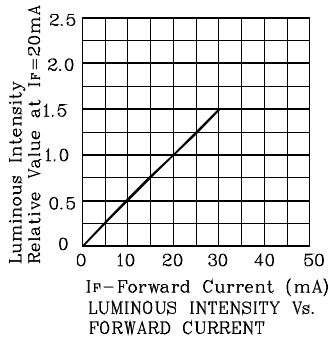
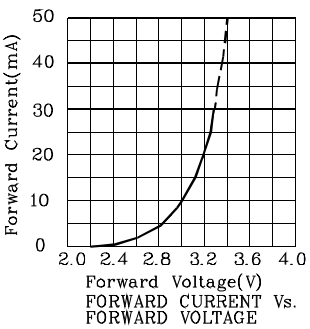

◆ Blue

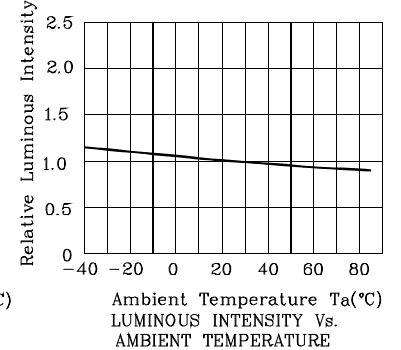
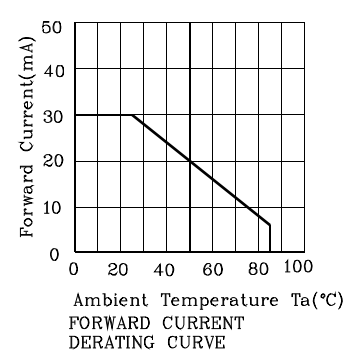
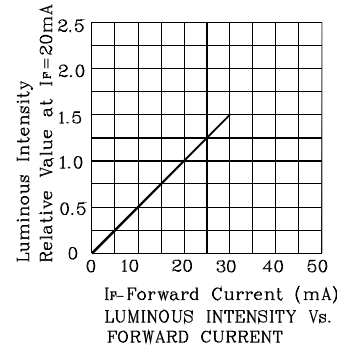
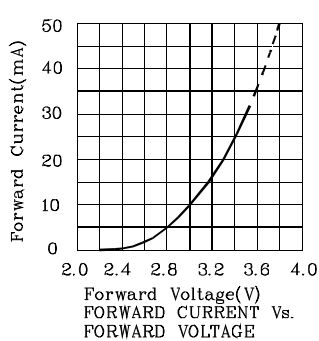

LED is recommended for reflow soldering and soldering profile is shown below.

❖ The device has a single mounting surface. The device must be mounted according to the specifications.

Reflow Soldering Profile for SMD Products (Pb-Free Components)

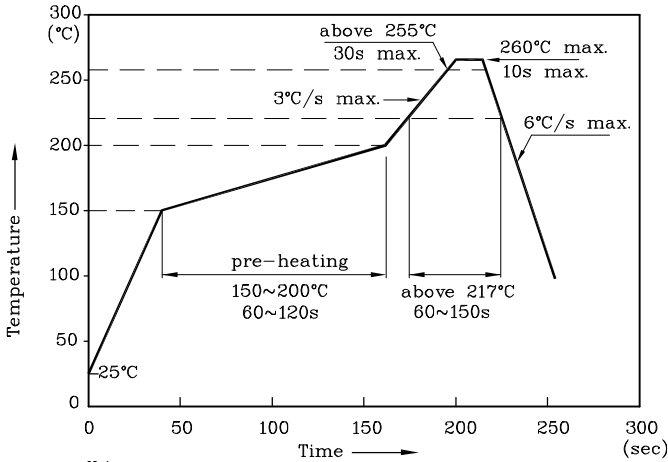

Notes:

1. All temperatures refer to the center of the package, measured on the package body surface facing up during reflow.
2. Do not apply any stress to the LED during high temperature conditions.
3. Maximum number of soldering passes: 2

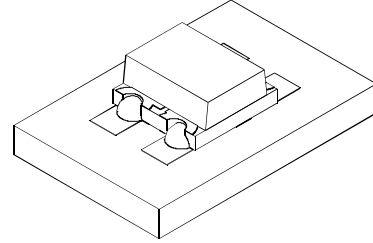

❖ Recommended Soldering Pattern (Units : mm; Tolerance: ± 0.1)

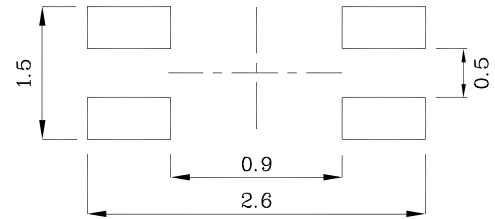

❖ Tape Specification (Units : mm)

❖ Reel Dimension

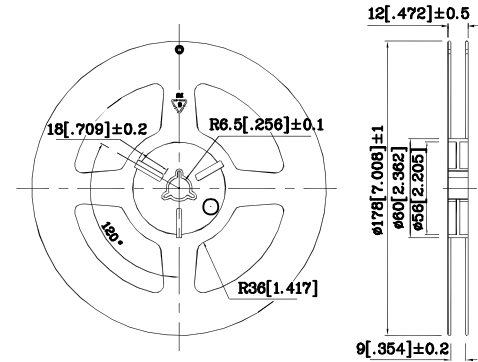
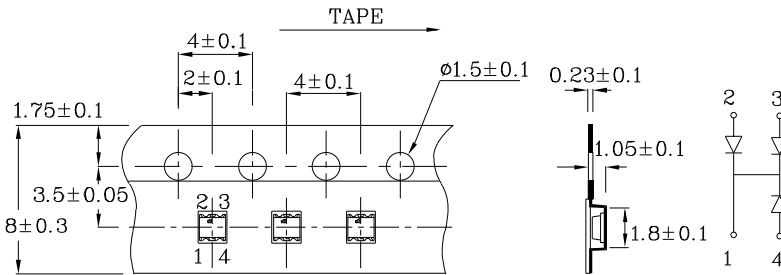

Remarks:

If special sorting is required (e.g. binning based on forward voltage, Luminous intensity / luminous flux, or wavelength), the typical accuracy of the sorting process is as follows:

1. Wavelength: +/-1nm
2. Luminous intensity / luminous flux: +/-15%
3. Forward Voltage: +/-0.1V

Note: Accuracy may depend on the sorting parameters.

**PACKING & LABEL SPECIFICATIONS**

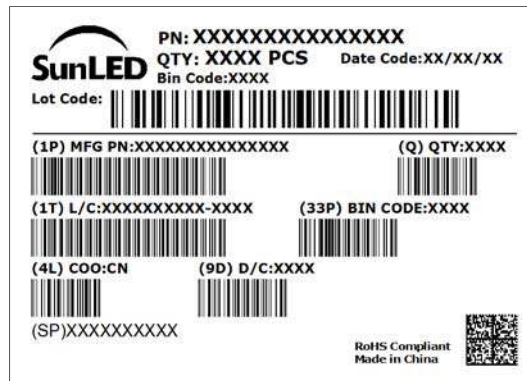
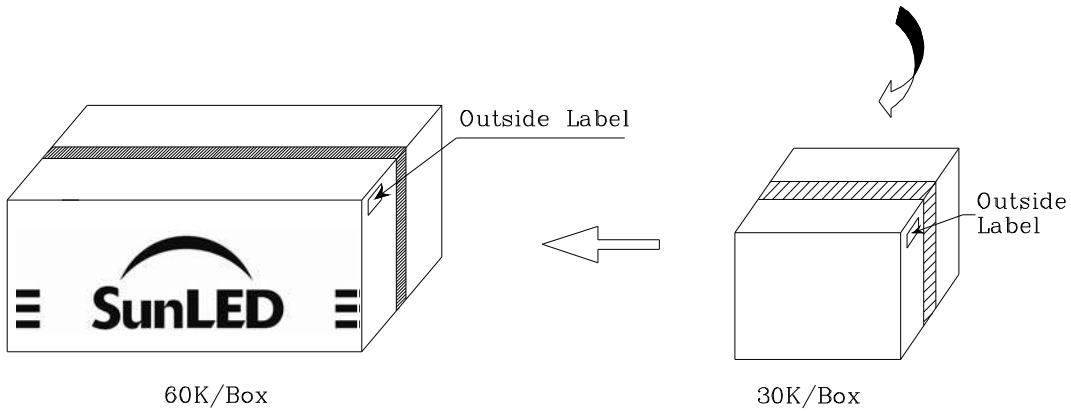
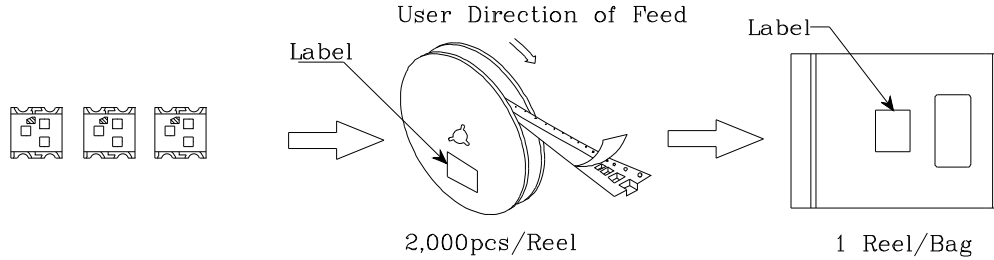

**TERMS OF USE**

1. Data presented in this document reflect statistical figures and should be treated as technical reference only.
2. Contents within this document are subject to improvement and enhancement changes without notice.
3. The product(s) in this document are designed to be operated within the electrical and environmental specifications indicated on the datasheet. User accepts full risk and responsibility when operating the product(s) beyond their intended specifications.
4. The product(s) described in this document are intended for electronic applications in which a person's life is not reliant upon the LED. Please consult with a SunLED representative for special applications where the LED may have a direct impact on a person's life.
5. The contents within this document may not be altered without prior consent by SunLED.
6. Additional technical notes are available at <https://www.SunLEDusa.com/TechnicalNotes.asp>