

LEILA-Y-W

~36° wide beam. 14.8 mm high assembly with holder, installation tape and pins.

SPECIFICATION:

Dimensions	Ø 21.6 mm
Height	14.8 mm
Fastening	tape, pin
ROHS compliant	yes ⓘ



MATERIALS:

Component	Type	Material	Colour	Finish
LEILA-Y-W	Single lens	PMMA	clear	
LEILA-Y-HLD	Holder	PC	black	gloss
LEILA-Y-TAPE	Tape	Acrylic foam		



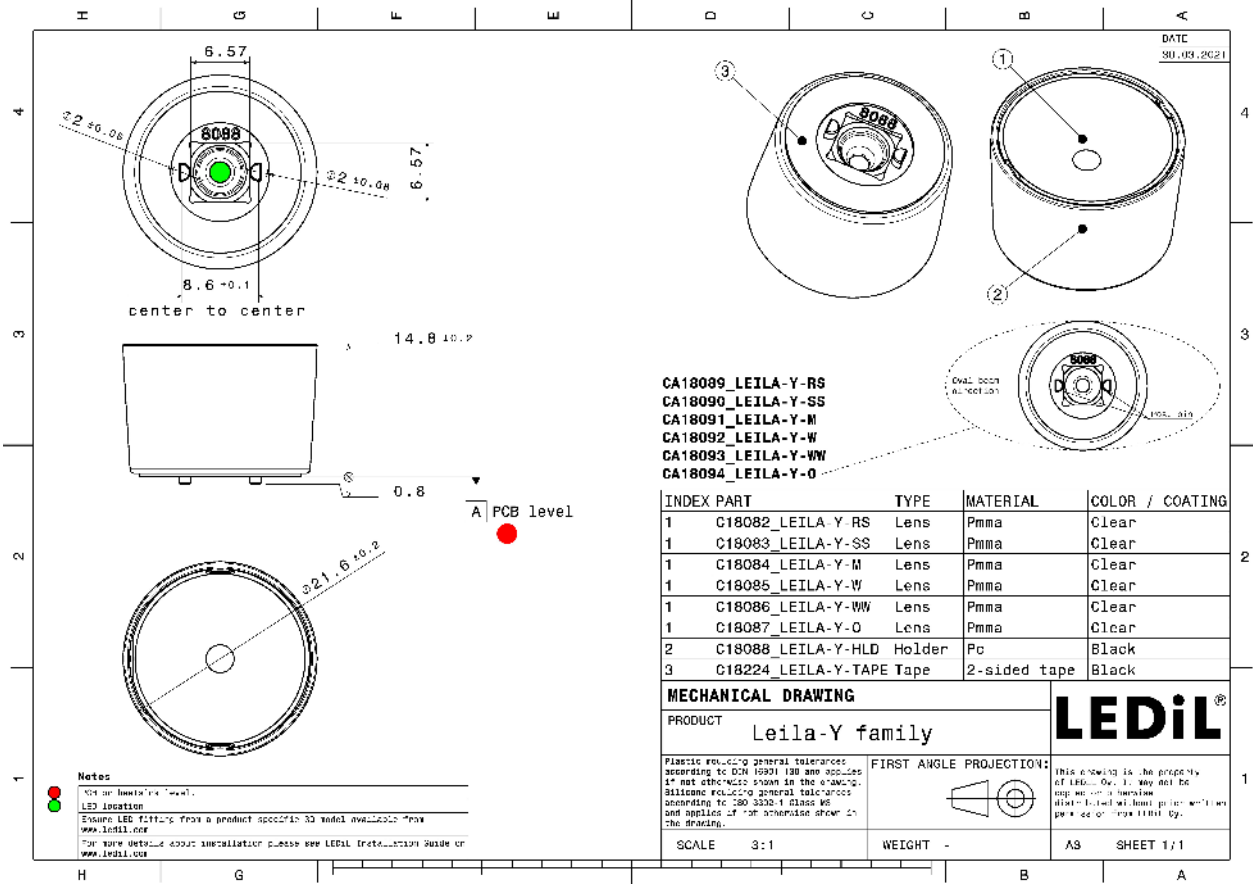

ORDERING INFORMATION:

Component	Qty in box	MOQ	MPQ	Box weight (kg)
CA18092_LEILA-Y-W » Box size: 476 x 273 x 197 mm	1800	180	180	6.6

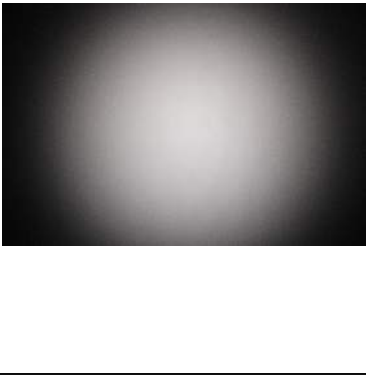
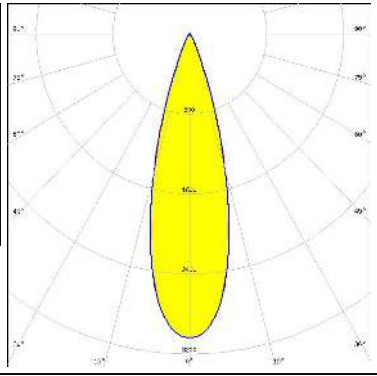

See also our general installation guide: www.ledil.com/installation_guide

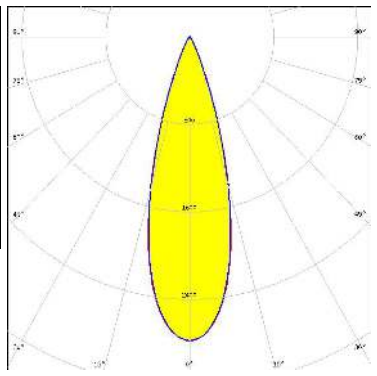
OPTICAL RESULTS (MEASURED):

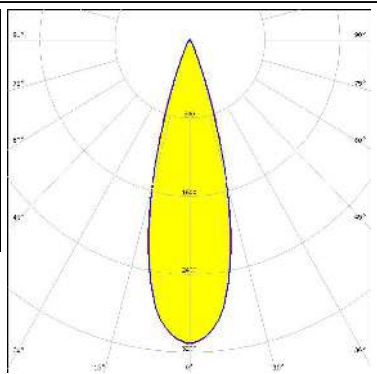
<p>CREE LEDs</p> <p>LED XHP35 HI FWHM / FWTM 29.0° / 48.0° Efficiency 83 % Peak intensity 3.1 cd/m LEDs/each optic 1 Light colour White Required components:</p>		
<p>CREE LEDs</p> <p>LED XP-G3 FWHM / FWTM 31.0° / 49.0° Efficiency 81 % Peak intensity 2.8 cd/m LEDs/each optic 1 Light colour White Required components:</p>		
<p>NICHIA</p> <p>LED NVSW719AC FWHM / FWTM 30.0° / 46.0° Efficiency 84 % Peak intensity 3.1 cd/m LEDs/each optic 1 Light colour White Required components:</p>		

OPTICAL RESULTS (SIMULATED):





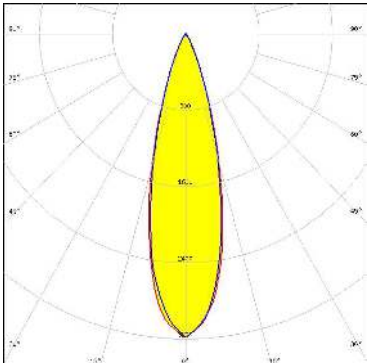
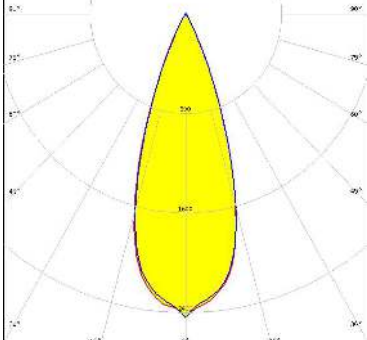
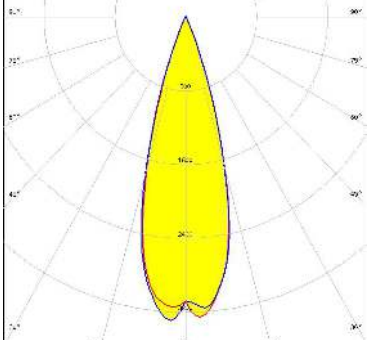
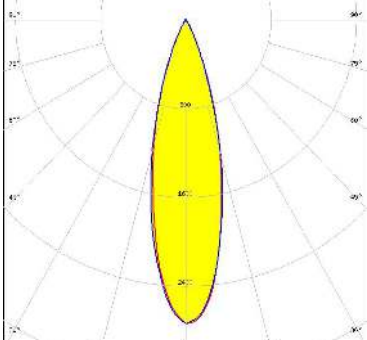

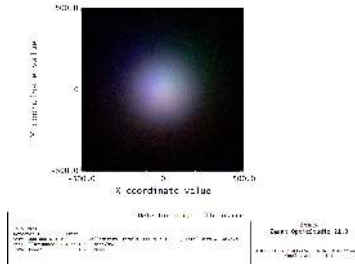
<p>CREE LEDs</p> <p>LED XM-L RGBW (XMLDCL HD)</p> <p>FWHM / FWTM 31.0° / 56.0°</p> <p>Efficiency 89 %</p> <p>Peak intensity 2.8 cd/lm</p> <p>LEDs/each optic 1</p> <p>Light colour RGBW</p> <p>Required components:</p>	
<p>CREE LEDs</p> <p>LED XM-L RGBW (XMLDCL HI)</p> <p>FWHM / FWTM 26.0° / 46.0°</p> <p>Efficiency 87 %</p> <p>Peak intensity 3.8 cd/lm</p> <p>LEDs/each optic 1</p> <p>Light colour RGBW</p> <p>Required components:</p>	
<p>CREE LEDs</p> <p>LED XM-L3</p> <p>FWHM / FWTM 35.0° / 56.0°</p> <p>Efficiency 81 %</p> <p>Peak intensity 2.3 cd/lm</p> <p>LEDs/each optic 1</p> <p>Light colour White</p> <p>Required components:</p>	
<p>LUMILEDS</p> <p>LED LUXEON 5050 Round LES</p> <p>FWHM / FWTM 28.0° / 48.0°</p> <p>Efficiency 84 %</p> <p>Peak intensity 3.3 cd/lm</p> <p>LEDs/each optic 1</p> <p>Light colour White</p> <p>Required components:</p>	

OPTICAL RESULTS (SIMULATED):

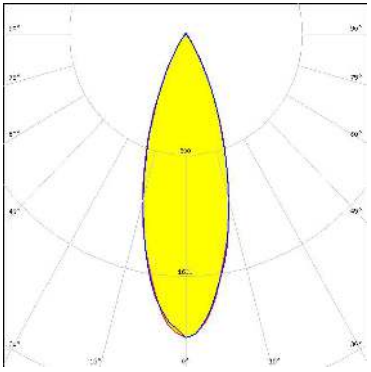
<p>LUMILEDS</p> <p>LED: LUXEON 5050 Square LES</p> <p>FWHM / FWTM: 28.0° / 50.0°</p> <p>Efficiency: 83 %</p> <p>Peak intensity: 3.2 cd/lm</p> <p>LEDs/each optic: 1</p> <p>Light colour: White</p> <p>Required components:</p>	
<p>LUMILEDS</p> <p>LED: LUXEON HL2X</p> <p>FWHM / FWTM: 36.0° / 54.0°</p> <p>Efficiency: 87 %</p> <p>Peak intensity: 2.4 cd/lm</p> <p>LEDs/each optic: 1</p> <p>Light colour: White</p> <p>Required components:</p>	
<p>LUMILEDS</p> <p>LED: LUXEON Z ES</p> <p>FWHM / FWTM: 30.0° / 46.0°</p> <p>Efficiency: 86 %</p> <p>Peak intensity: 3.3 cd/lm</p> <p>LEDs/each optic: 1</p> <p>Light colour: White</p> <p>Required components:</p>	
<p>NICHIA</p> <p>LED: NCSxE17A</p> <p>FWHM / FWTM: 28.0° / 51.0°</p> <p>Efficiency: 74 %</p> <p>Peak intensity: 2.8 cd/lm</p> <p>LEDs/each optic: 4</p> <p>Light colour: RGBW</p> <p>Required components:</p>	

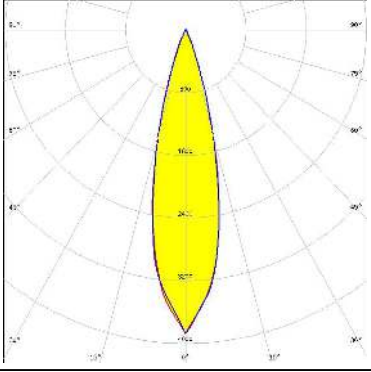

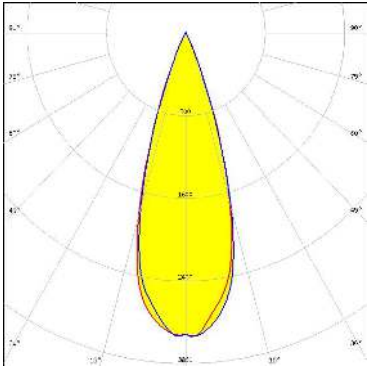
OPTICAL RESULTS (SIMULATED):

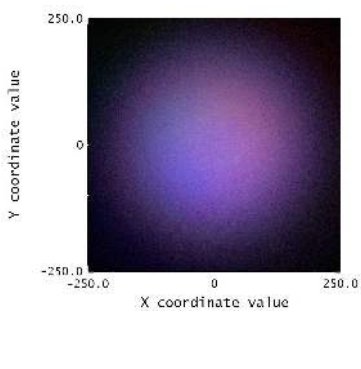
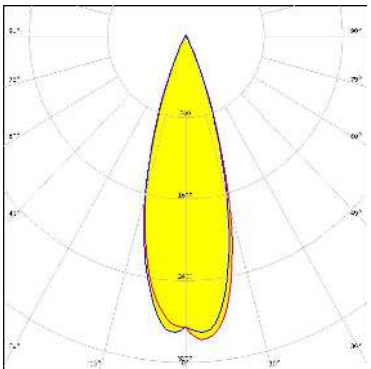
	<p>LED NV4x144A FWHM / FWTM 34.0° / 60.0° Efficiency 76 % Peak intensity 2 cd/lm LEDs/each optic 1 Light colour White Required components:</p>		
	<p>LED NVSxE21A FWHM / FWTM 26.0° / 44.0° Efficiency 80 % Peak intensity 3.9 cd/lm LEDs/each optic 1 Light colour White Required components:</p>		
 <p>Opto Semiconductors</p>	<p>LED OSOLON SSL 150 FWHM / FWTM 33.0° / 48.0° Efficiency 86 % Peak intensity 3 cd/lm LEDs/each optic 1 Light colour White Required components:</p>		
 <p>Opto Semiconductors</p>	<p>LED OSTAR Stage (S2WM) FWHM / FWTM 32.0° / 50.0° Efficiency 86 % Peak intensity 3 cd/lm LEDs/each optic 1 Light colour White Required components:</p>		

OPTICAL RESULTS (SIMULATED):

SAMSUNG

LED LH351B
FWHM / FWTM 34.0° / 52.0°
Efficiency 86 %
Peak intensity 2.6 cd/lm
LEDs/each optic 1
Light colour White
Required components:

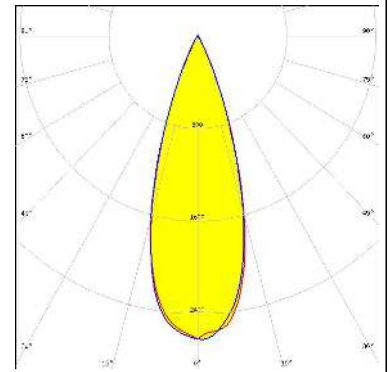

LED Z5M4
FWHM / FWTM 28.0° / 48.0°
Efficiency 85 %
Peak intensity 3.4 cd/lm
LEDs/each optic 1
Light colour White
Required components:

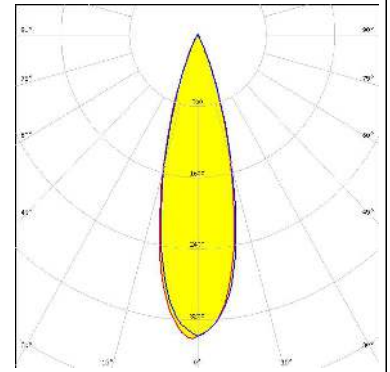

GENERAL INFORMATION:

NOTE: The typical beam angle will be changed by different color, chip size and chip position tolerance. The typical total beam angle is the full angle measured where the luminous intensity is half of the peak value.

MATERIALS:

As part of our continuous research and improvement processes, and to ensure the best possible quality and availability of our products, LEDiL reserves the right to change material grades without notice.

PRODUCT DATA USER AGREEMENT AND DISCLAIMER:

The measured data in the provided downloadable LEDiL Product Datasheets and Mechanical 2D-Drawings is rounded and provided as reference for planning. LEDiL Oy's optical specifications have been verified by conducting performance testing of the products in accordance with the company's quality system. The reported data are averaged results of multiple measurements with typical variation. LEDiL Oy reserves the right to without prior notification make changes and improvements to its products.

LEDiL Oy assumes neither warranty, nor guarantee nor any other liability of any kind for the contents and correctness of the provided data. The provided data has been generated with highest diligence but the provided data may in reality not represent the complete possible variation range of all intrinsic parameters. Therefore, in certain cases a deviation from the provided data could occur.

LEDiL Oy reserves the right to undertake technical changes of its products without further notification which could lead to changes in the provided data. LEDiL Oy assumes no liability of any kind for the possible deviation from any provided data or any other damage resulting from the usage of the provided data.

The user agrees to this disclaimer and user agreement with the download or usage of the provided files.

LEDiL Oy

Joensuunkatu 13
FI-24240 SALO
Finland

LEDiL Inc.

228 West Page Street
Suite D
Sycamore IL 60178
USA

Ledil Optics Technology (Shenzhen) Co., Ltd.

405 , Block B
Casic Motor Building
Shenzhen 518057
P.R.CHINA

Local sales and technical support

[www.ledil.com/
where_to_buy](http://www.ledil.com/where_to_buy)

Shipping locations

Salo, Finland
Hong Kong, China

Distribution Partners

[www.ledil.com/
where_to_buy](http://www.ledil.com/where_to_buy)