

REV.	DATE	ECR NO.	DESCRIPTION
NC	08/07/06	XXXXXX	INITIAL RELEASE
A	02/26/14	2708	MODIFY CABLE STRIPPING DIMENSION, UPDATED DRAWING FORMAT

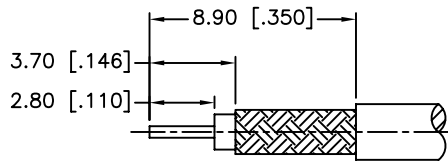

RECOMMENDED
CABLE STRIPPING DIM'S

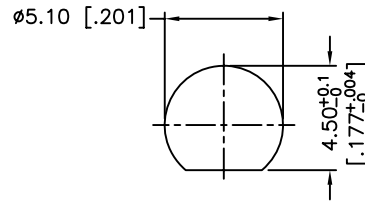

RECOMMENDED
MOUNTING HOLE

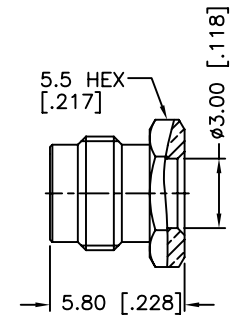
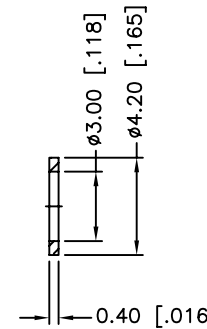
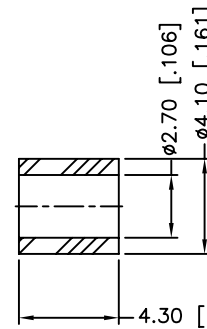
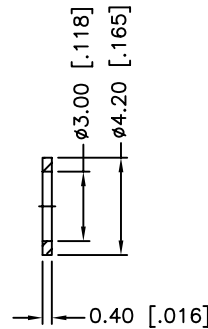
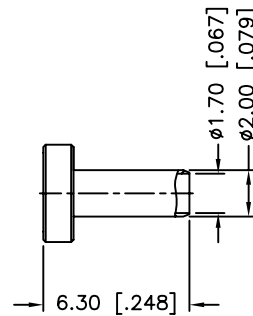
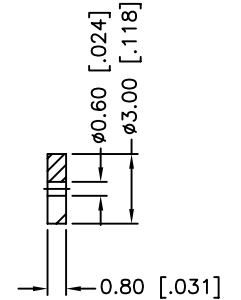
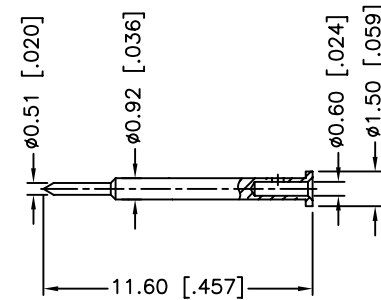
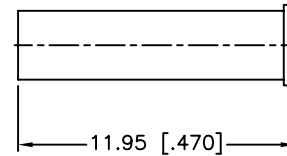
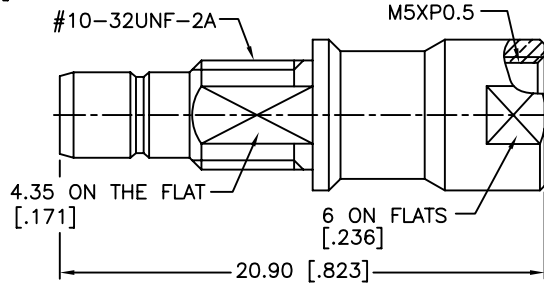
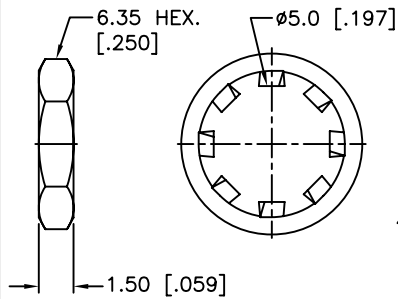

1. IMPEDANCE: 50 OHM
2. FREQUENCY RANGE: 0-3 GHZ
3. VSWR: 1.3 MAX.
4. DIELECTRIC WITHSTANDING VOLTAGE: 900 VRMS, MIN.
5. DURABILITY: 500 CYCLES MIN.
6. TEMPERATURE RANGE: -65°C TO +165°C

QTY	DESCRIPTION	MATERIAL	FINISH	QTY
10	HEX NUT	BRASS	GOLD	1
9	LOCK WASHER	BRASS	GOLD	1
8	HEX NUT	BRASS	GOLD	1
7	GASKET	SILICONE RUBBER	RED	1
6	WASHER	BRASS	GOLD	2
5	TOP HAT	BRASS	GOLD	1
4	INSULATOR	PTFE	NATURAL	1
3	CONTACT PIN	BRASS	GOLD	1
2	INSULATOR	PTFE	NATURAL	1
1	BODY	BRASS	GOLD	1

UNLESS OTHERWISE SPECIFIED DIMENSIONS ARE IN MILLIMETERS. DIMENSIONS IN [] ARE IN INCHES AND FOR CUSTOMER REFERENCE ONLY.
 TOLERANCES FOR MILLIMETERS ARE:
 <0.5 ± 0.05mm
 0.5 - 6mm ± 0.10mm
 6 - 30mm ± 0.20mm
 30 - 120mm ± 0.30mm
 ANGLES ± 1°
 UNLESS OTHERWISE SPECIFIED TOLERANCES FOR INCHES ARE:
 <.020 ± 0.002"
 .020 - .236 ± 0.004"
 .236 - 1.180 ± 0.007"
 1.180 - 4.724 ± 0.012"
 ANGLES ± 1°
 DO NOT SCALE DRAWING

APPROVALS	DATE
DRAWN M.ZHANG	02/26/14
CHECKED	
ISSUED	
SHEET 1 OF 1	
CAD FILE C:/CONNEX/142126.DWG	

PART DESCRIPTION			
Amphenol Connex			
SMB BULKHEAD CLAMP JACK (FOR RG-316/U, 174/U CABLE)			
PART NO.		142126	
DWG. NO.	142126.DWG	REV.	A
SIZE	A	SCALE	NA