

Universal module - UM-2KS50/UNI/CS/Z/SO180 - 2311399

Please be informed that the data shown in this PDF Document is generated from our Online Catalog. Please find the complete data in the user's documentation. Our General Terms of Use for Downloads are valid (<http://phoenixcontact.com/download>)



Universal module for connection with up to 32 channel digital Yokogawa cards, 1:1 connection of the Yokogawa system connector on spring-cage connection.

The figure shows a version with a screw connection



Key Commercial Data

Packing unit	1 STK
Weight per Piece (excluding packing)	278.400 g
Custom tariff number	85369010
Country of origin	Germany

Technical data

Dimensions

Width	140 mm
Height	126 mm
Depth	65 mm

Ambient conditions

Ambient temperature (operation)	-20 °C ... 50 °C
Ambient temperature (storage/transport)	-20 °C ... 70 °C

General

Max. perm. operating voltage	24 V DC \pm 10 %
Max. perm. current (per branch)	100 mA
Mounting position	any
Standards/regulations	DIN EN 50178

Universal module - UM-2KS50/UNI/CS/Z/SO180 - 2311399

Technical data

General

Rated surge voltage	0.5 kV
Degree of pollution	2
Overvoltage category	II

Connection data for connection 1

Connection name	Field level
Connection method	Spring-cage connection
Conductor cross section solid	0.2 mm ² ... 2.5 mm ²
Conductor cross section flexible	0.2 mm ² ... 1.5 mm ²
Conductor cross section AWG	24 ... 14
Number of positions	32

Connection data for connection 2

Connection name	Controller level
Connection method	Yokogawa KS-compatible
Torque	0.5 Nm
Number of connections	2
Number of positions	50
Note	Usable system cables: Phoenix Contact YUC50, Yokogawa AKB331

Supported controller

Controller	YOKOGAWA CS3000 CentumVP
- suitable I/O card	ADV151
	ADV161
	ADV551
	ADV561
Controller	YOKOGAWA STARDOM
- suitable I/O card	NFDV151
	NFDV161
	NFDV551
	NFDV561

Standards and Regulations

Standards/regulations	DIN EN 50178
Degree of pollution	2
Overvoltage category	II

Drawings

Universal module - UM-2KS50/UNI/CS/Z/SO180 - 2311399

Circuit diagram

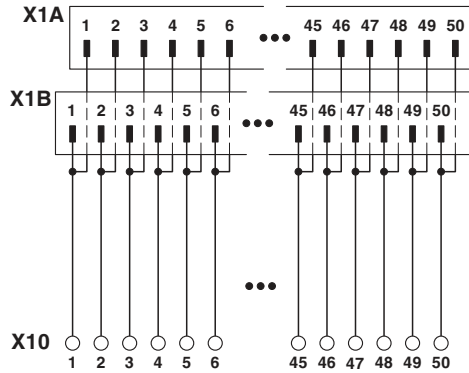

Dimensional drawing

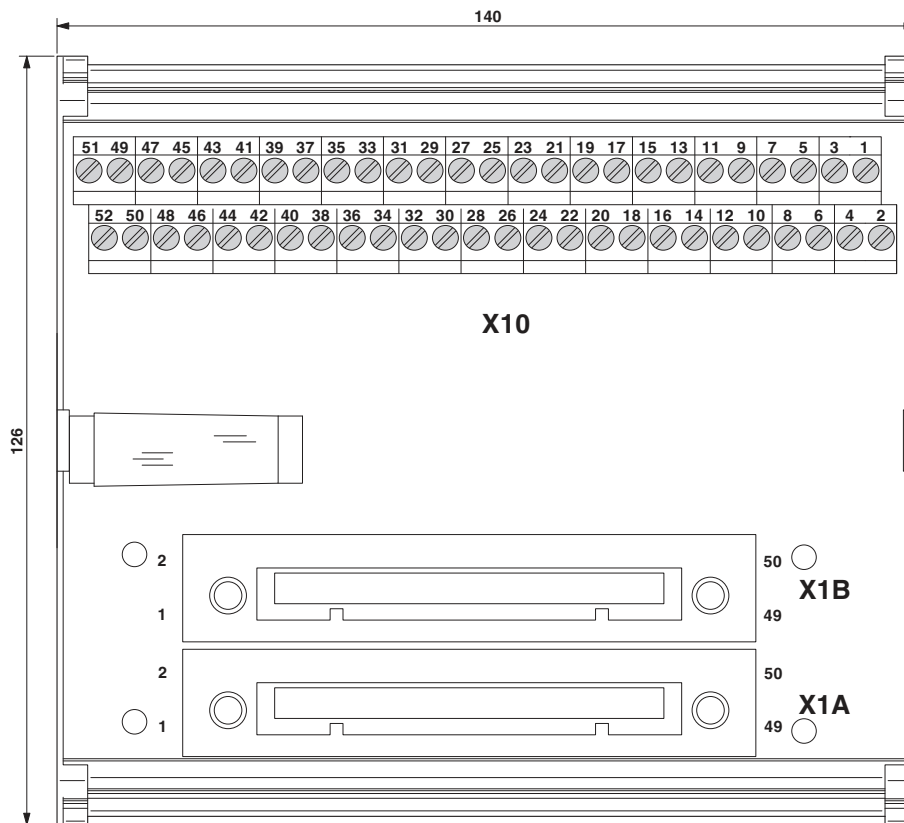

The figure shows a version with a screw connection

Universal module - UM-2KS50/UNI/CS/Z/SO180 - 2311399

Classifications

eCl@ss

eCl@ss 4.0	27250313
eCl@ss 4.1	27250313
eCl@ss 5.0	27250313
eCl@ss 5.1	27250313
eCl@ss 6.0	27069203
eCl@ss 7.0	27069203
eCl@ss 8.0	27141152
eCl@ss 9.0	27141152

ETIM

ETIM 2.0	EC001434
ETIM 3.0	EC001604
ETIM 4.0	EC001437
ETIM 5.0	EC002780

UNSPSC

UNSPSC 6.01	30211824
UNSPSC 7.0901	39121421
UNSPSC 11	39121421
UNSPSC 12.01	39121421
UNSPSC 13.2	39121421

Accessories

Accessories

Front adapter

Front adapters - FLK 50-PA/EZ-DR/KS/ 100/YUC - 2900991



Cast front adapter with attached round cable and a 50-pos. socket strip injection-molded on both sides for the connection of Yokogawa controllers. Cable length: 1.0 m

Universal module - UM-2KS50/UNI/CS/Z/SO180 - 2311399

Accessories

Front adapters - FLK 50-PA/EZ-DR/KS/ 200/YUC - 2314299



Cast front adapter with attached round cable and a 50-pos. socket strip injection-molded on both sides for the connection of Yokogawa controllers. Cable length: 2.0 m

Front adapters - FLK 50-PA/EZ-DR/KS/ 300/YUC - 2314309



Cast front adapter with attached round cable and a 50-pos. socket strip injection-molded on both sides for the connection of Yokogawa controllers. Cable length: 3.0 m

Front adapters - FLK 50-PA/EZ-DR/KS/ 400/YUC - 2314312



Cast front adapter with attached round cable and a 50-pos. socket strip injection-molded on both sides for the connection of Yokogawa controllers. Cable length: 4.0 m

Front adapters - FLK 50-PA/EZ-DR/KS/ 500/YUC - 2321499



Cast front adapter with attached round cable and a 50-pos. socket strip injection-molded on both sides for the connection of Yokogawa controllers. Cable length: 5.0 m

Front adapters - FLK 50-PA/EZ-DR/KS/ 600/YUC - 2314927



Cast front adapter with attached round cable and a 50-pos. socket strip injection-molded on both sides for the connection of Yokogawa controllers. Cable length: 6.0 m

Universal module - UM-2KS50/UNI/CS/Z/SO180 - 2311399

Accessories

Front adapters - FLK 50-PA/EZ-DR/KS/ 700/YUC - 2321509



Cast front adapter with attached round cable and a 50-pos. socket strip injection-molded on both sides for the connection of Yokogawa controllers. Cable length: 7.0 m

Front adapters - FLK 50-PA/EZ-DR/KS/ 800/YUC - 2314930



Cast front adapter with attached round cable and a 50-pos. socket strip injection-molded on both sides for the connection of Yokogawa controllers. Cable length: 8.0 m

Front adapters - FLK 50-PA/EZ-DR/KS/ 900/YUC - 2321512



Cast front adapter with attached round cable and a 50-pos. socket strip injection-molded on both sides for the connection of Yokogawa controllers. Cable length: 9.0 m

Front adapters - FLK 50-PA/EZ-DR/KS/1000/YUC - 2314325



Cast front adapter with attached round cable and a 50-pos. socket strip injection-molded on both sides for the connection of Yokogawa controllers. Cable length: 10.0 m

Front adapters - FLK 50-PA/EZ-DR/KS/1100/YUC - 2321389



Cast front adapter with attached round cable and a 50-pos. socket strip injection-molded on both sides for the connection of Yokogawa controllers. Cable length: 11.0 m

Universal module - UM-2KS50/UNI/CS/Z/SO180 - 2311399

Accessories

Front adapters - FLK 50-PA/EZ-DR/KS/1200/YUC - 2321525



Cast front adapter with attached round cable and a 50-pos. socket strip injection-molded on both sides for the connection of Yokogawa controllers. Cable length: 12.0 m

Front adapters - FLK 50-PA/EZ-DR/KS/1300/YUC - 2321392



Cast front adapter with attached round cable and a 50-pos. socket strip injection-molded on both sides for the connection of Yokogawa controllers. Cable length: 13.0 m

Front adapters - FLK 50-PA/EZ-DR/KS/1400/YUC - 2321402



Cast front adapter with attached round cable and a 50-pos. socket strip injection-molded on both sides for the connection of Yokogawa controllers. Cable length: 14.0 m

Front adapters - FLK 50-PA/EZ-DR/KS/1500/YUC - 2314338



Cast front adapter with attached round cable and a 50-pos. socket strip injection-molded on both sides for the connection of Yokogawa controllers. Cable length: 15.0 m

Front adapters - FLK 50-PA/EZ-DR/KS/1600/YUC - 2321538



Cast front adapter with attached round cable and a 50-pos. socket strip injection-molded on both sides for the connection of Yokogawa controllers. Cable length: 16.0 m

Universal module - UM-2KS50/UNI/CS/Z/SO180 - 2311399

Accessories

Front adapters - FLK 50-PA/EZ-DR/KS/1700/YUC - 2321541



Cast front adapter with attached round cable and a 50-pos. socket strip injection-molded on both sides for the connection of Yokogawa controllers. Cable length: 17.0 m

Front adapters - FLK 50-PA/EZ-DR/KS/1800/YUC - 2321554



Cast front adapter with attached round cable and a 50-pos. socket strip injection-molded on both sides for the connection of Yokogawa controllers. Cable length: 18.0 m

Front adapters - FLK 50-PA/EZ-DR/KS/1900/YUC - 2321567



Cast front adapter with attached round cable and a 50-pos. socket strip injection-molded on both sides for the connection of Yokogawa controllers. Cable length: 19.0 m

Front adapters - FLK 50-PA/EZ-DR/KS/2000/YUC - 2314503



Cast front adapter with attached round cable and a 50-pos. socket strip injection-molded on both sides for the connection of Yokogawa controllers. Cable length: 20.0 m

Front adapters - FLK 50-PA/EZ-DR/KS/2500/YUC - 2314516



Cast front adapter with attached round cable and a 50-pos. socket strip injection-molded on both sides for the connection of Yokogawa controllers. Cable length: 25.0 m

Universal module - UM-2KS50/UNI/CS/Z/SO180 - 2311399

Accessories

Front adapters - FLK 50-PA/EZ-DR/KS/3000/YUC - 2314529



Cast front adapter with attached round cable and a 50-pos. socket strip injection-molded on both sides for the connection of Yokogawa controllers. Cable length: 30.0 m

Front adapters - FLK 50-PA/EZ-DR/KS/5000/YUC - 2318981



Cast front adapter with attached round cable and a 50-pos. socket strip injection-molded on both sides for the connection of Yokogawa controllers. Cable length: 50.0 m

Front adapters - FLK 50-PA/EZ-DR/HF/KS/ 100/YUC - 2904739



Cast front adapter with attached, halogen-free round cable and a 50-pos. socket strip injection-molded on both sides for the connection of Yokogawa controllers. Cable length: 1.0 m

Front adapters - FLK 50-PA/EZ-DR/HF/KS/ 200/YUC - 2904740



Cast front adapter with attached, halogen-free round cable and a 50-pos. socket strip injection-molded on both sides for the connection of Yokogawa controllers. Cable length: 2.0 m

Front adapters - FLK 50-PA/EZ-DR/HF/KS/ 300/YUC - 2904741



Cast front adapter with attached, halogen-free round cable and a 50-pos. socket strip injection-molded on both sides for the connection of Yokogawa controllers. Cable length: 3.0 m

Universal module - UM-2KS50/UNI/CS/Z/SO180 - 2311399

Accessories

Front adapters - FLK 50-PA/EZ-DR/HF/KS/ 400/YUC - 2904742



Cast front adapter with attached, halogen-free round cable and a 50-pos. socket strip injection-molded on both sides for the connection of Yokogawa controllers. Cable length: 4.0 m

Front adapters - FLK 50-PA/EZ-DR/HF/KS/ 500/YUC - 2904636



Cast front adapter with attached, halogen-free round cable and a 50-pos. socket strip injection-molded on both sides for the connection of Yokogawa controllers. Cable length: 5.0 m

Front adapters - FLK 50-PA/EZ-DR/HF/KS/ 600/YUC - 2904743



Cast front adapter with attached, halogen-free round cable and a 50-pos. socket strip injection-molded on both sides for the connection of Yokogawa controllers. Cable length: 6.0 m

Front adapters - FLK 50-PA/EZ-DR/HF/KS/ 700/YUC - 2904744



Cast front adapter with attached, halogen-free round cable and a 50-pos. socket strip injection-molded on both sides for the connection of Yokogawa controllers. Cable length: 7.0 m

Front adapters - FLK 50-PA/EZ-DR/HF/KS/ 800/YUC - 2904745



Cast front adapter with attached, halogen-free round cable and a 50-pos. socket strip injection-molded on both sides for the connection of Yokogawa controllers. Cable length: 8.0 m

Universal module - UM-2KS50/UNI/CS/Z/SO180 - 2311399

Accessories

Front adapters - FLK 50-PA/EZ-DR/HF/KS/ 900/YUC - 2904746



Cast front adapter with attached, halogen-free round cable and a 50-pos. socket strip injection-molded on both sides for the connection of Yokogawa controllers. Cable length: 9.0 m

Front adapters - FLK 50-PA/EZ-DR/HF/KS/1000/YUC - 2904637



Cast front adapter with attached, halogen-free round cable and a 50-pos. socket strip injection-molded on both sides for the connection of Yokogawa controllers. Cable length: 10.0 m

Front adapters - FLK 50-PA/EZ-DR/HF/KS/1500/YUC - 2904638



Cast front adapter with attached, halogen-free round cable and a 50-pos. socket strip injection-molded on both sides for the connection of Yokogawa controllers. Cable length: 15.0 m

Front adapters - FLK 50-PA/EZ-DR/HF/KS/2000/YUC - 2904487



Cast front adapter with attached, halogen-free round cable and a 50-pos. socket strip injection-molded on both sides for the connection of Yokogawa controllers. Cable length: 20.0 m

Front adapters - FLK 50-PA/EZ-DR/HF/KS/2500/YUC - 2904639



Cast front adapter with attached, halogen-free round cable and a 50-pos. socket strip injection-molded on both sides for the connection of Yokogawa controllers. Cable length: 25.0 m

Universal module - UM-2KS50/UNI/CS/Z/SO180 - 2311399

Accessories

Front adapters - FLK 50-PA/EZ-DR/HF/KS/3000/YUC - 2904640



Cast front adapter with attached, halogen-free round cable and a 50-pos. socket strip injection-molded on both sides for the connection of Yokogawa controllers. Cable length: 30.0 m

Front adapters - FLK 50-PA/EZ-DR/HF/KS/3500/YUC - 2904641



Cast front adapter with attached, halogen-free round cable and a 50-pos. socket strip injection-molded on both sides for the connection of Yokogawa controllers. Cable length: 35.0 m

Front adapters - FLK 50-PA/EZ-DR/HF/KS/4000/YUC - 2904642



Cast front adapter with attached, halogen-free round cable and a 50-pos. socket strip injection-molded on both sides for the connection of Yokogawa controllers. Cable length: 40.0 m

Front adapters - FLK 50-PA/EZ-DR/HF/KS/4500/YUC - 2904643



Cast front adapter with attached, halogen-free round cable and a 50-pos. socket strip injection-molded on both sides for the connection of Yokogawa controllers. Cable length: 45.0 m

Front adapters - FLK 50-PA/EZ-DR/HF/KS/5000/YUC - 2904644



Cast front adapter with attached, halogen-free round cable and a 50-pos. socket strip injection-molded on both sides for the connection of Yokogawa controllers. Cable length: 50.0 m

System cable

Universal module - UM-2KS50/UNI/CS/Z/SO180 - 2311399

Accessories

Cable - FLK-MIL50/EZ-DR/KS/ 200/YCS - 2314590



Round cable set for Yokogawa CS3000 CentumVP ADV561, ADV161 with 1 x IDC/FLK socket strip (50-position) on 1 x Yokogawa, KS compatible (50-position), Cable length: 2 m

Cable - FLK-MIL50/EZ-DR/KS/ 300/YCS - 2314781



Assembled shielded round cable for Yokogawa CS3000 CentumVP ADV561, ADV161 with 1 x IDC/FLK socket strip (50-position) on 1 x Yokogawa, KS compatible (50-position), Cable length: 3 m

Cable - FLK-MIL50/EZ-DR/KS/ 400/YCS - 2314794



Assembled shielded round cable for Yokogawa CS3000 CentumVP ADV561, ADV161 with 1 x IDC/FLK socket strip (50-position) on 1 x Yokogawa, KS compatible (50-position), Cable length: 4 m

Cable - FLK-MIL50/EZ-DR/KS/1000/YCS - 2314804



Assembled shielded round cable for Yokogawa CS3000 CentumVP ADV561, ADV161 with 1 x IDC/FLK socket strip (50-position) on 1 x Yokogawa, KS compatible (50-position), Cable length: 10 m

Cable - FLK-MIL50/EZ-DR/KS/1500/YCS - 2314817



Assembled shielded round cable for Yokogawa CS3000 CentumVP ADV561, ADV161 with 1 x IDC/FLK socket strip (50-position) on 1 x IDC/FLK socket strip (50-position), Cable length: 15 m

Universal module - UM-2KS50/UNI/CS/Z/SO180 - 2311399

Accessories

Cable - FLK-MIL50/EZ-DR/KS/2000/YCS - 2314820



Assembled shielded round cable for Yokogawa CS3000 CentumVP ADV561, ADV161 with 1 x IDC/FLK socket strip (50-position) on 1 x IDC/FLK socket strip (50-position), Cable length: 20 m

Cable - FLK-MIL50/EZ-DR/KS/3000/YCS - 2901018



Assembled shielded round cable for Yokogawa CS3000 CentumVP ADV561, ADV161 with 1 x IDC/FLK socket strip (50-position) on 1 x IDC/FLK socket strip (50-position), Cable length: 30 m

Cable - FLK-MIL50/EZ-DR/KS/3500/YCS - 2901019



Assembled shielded round cable for Yokogawa CS3000 CentumVP ADV561, ADV161 with 1 x IDC/FLK socket strip (50-position) on 1 x IDC/FLK socket strip (50-position), Cable length: 35 m

Cable - FLK-MIL50/EZ-DR/KS/4000/YCS - 2901020



Assembled shielded round cable for Yokogawa CS3000 CentumVP ADV561, ADV161 with 1 x IDC/FLK socket strip (50-position) on 1 x IDC/FLK socket strip (50-position), Cable length: 40 m

Cable - FLK-MIL50/EZ-DR/KS/8000/YCS - 2321868



Assembled shielded round cable for Yokogawa CS3000 CentumVP ADV561, ADV161 with 1 x IDC/FLK socket strip (50-position) on 1 x IDC/FLK socket strip (50-position), Cable length: 80 m

