

The copying, distribution and utilization of this document as well as the communication of the contents to others without expressed authorization is prohibited according to §18 UWG German Law. Offenders will be held liable for the payment of damages according to §19 UWG German Law. All rights reserved, in particular the right to carry out patent, utility model or ornamental design registrations.

Weitergabe sowie Vervielfältigung dieses Dokuments, Verwertung und Mitteilung seines Inhalts gem §18 UWG verboten, soweit nicht ausdrücklich gestattet. Zuwiderhandlungen verpflichten zu Schadenersatz (§19 UWG). Alle Rechte vorbehalten, insbesondere das Recht, Patent-, Gebrauchsmuster- oder Geschmacksmusteranmeldungen durchzuführen.
 CONINVERS GmbH Heisenbergstrasse 1 D-71083 Herrenberg

4pol A-Codierung
 (Steckseite)
 4pole A-coding
 (Plug-in side)

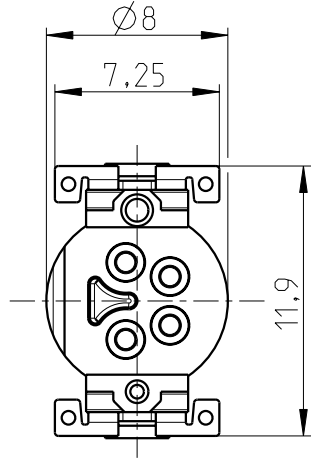
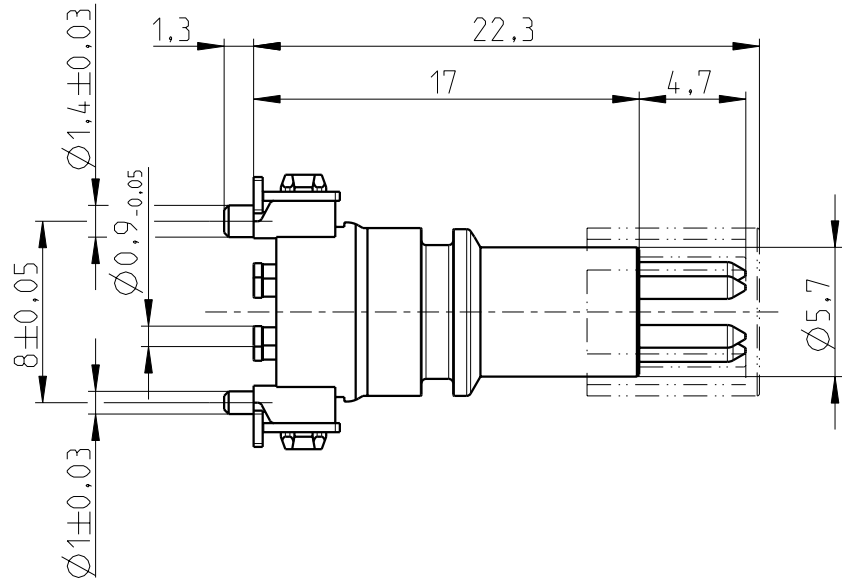
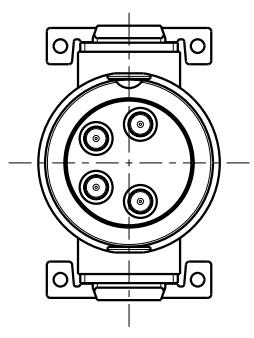

	Datum	Name
Bearb.	2014-09-22	Thumm

SACC-CI-M8MS-4P SMD ...



Technische Änderungen vorbehalten	Dok.-Nr.: 00775928	Index 1 / 2014-09-22	Blatt: 1 / 1
technical changes reserved	doc.-no.: 00775928	Index 1 / 2014-09-22	page: 1 / 1