

LM4908 Boomer[®] Audio Power Amplifier Series **10kV ESD Rated, Dual 120 mW Headphone Amplifier**

Check for Samples: [LM4908](#), [LM4908LQBD](#)

FEATURES

- Up to 10kV ESD Protection on All Pins
- VSSOP, SOIC, and WSON Surface Mount Packaging
- Switch On/Off Click Suppression
- Excellent Power Supply Ripple Rejection
- Unity-Gain Stable
- Minimum External Components

APPLICATIONS

- Headphone Amplifier
- Personal Computers
- Portable Electronic Devices

KEY SPECIFICATIONS

- THD+N at 1kHz at 120mW Continuous Average Output Power into 16Ω: 0.1 % (typ)
- THD+N at 1kHz at 75mW Continuous Average Output Power into 32Ω: 0.1 % (typ)
- Output Power at 0.1% THD+N at 1kHz into 32Ω 75 mW (typ)

DESCRIPTION

The LM4908 is a dual audio power amplifier capable of delivering 120mW per channel of continuous average power into a 16Ω load with 0.1% (THD+N) from a 5V power supply.

Boomer audio power amplifiers were designed specifically to provide high quality output power with a minimal amount of external components using surface mount packaging. Since the LM4908 does not require bootstrap capacitors or snubber networks, it is optimally suited for low-power portable systems.

The unity-gain stable LM4908 can be configured by external gain-setting resistors.



Please be aware that an important notice concerning availability, standard warranty, and use in critical applications of Texas Instruments semiconductor products and disclaimers thereto appears at the end of this data sheet.

All trademarks are the property of their respective owners.

Typical Application

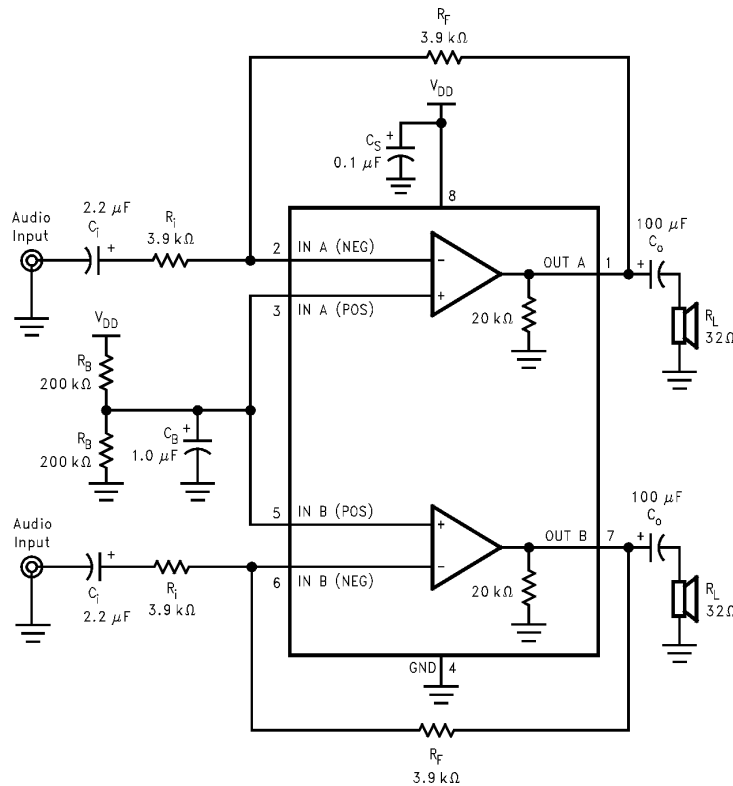

Refer to [APPLICATION INFORMATION](#) for information concerning proper selection of the input and output coupling capacitors.

Figure 1. Typical Audio Amplifier Application Circuit

Connection Diagram

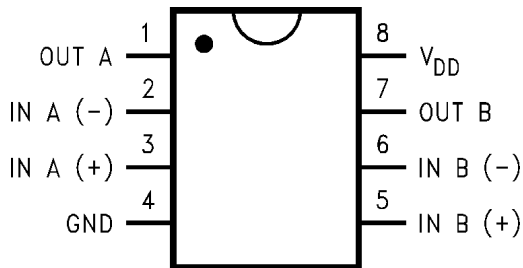

Figure 2. Top View SOIC (D) and VSSOP (DGK) Package
See Package Number D0008A, DGK0008A

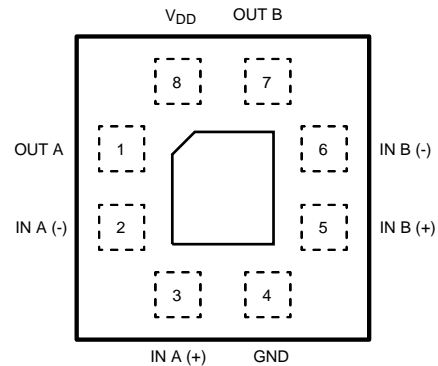

Figure 3. Top View WSON (NGP) Package
See Package Number NGP0008A



These devices have limited built-in ESD protection. The leads should be shorted together or the device placed in conductive foam during storage or handling to prevent electrostatic damage to the MOS gates.

ABSOLUTE MAXIMUM RATINGS ⁽¹⁾⁽²⁾

Supply Voltage		6.0V	
Storage Temperature		-65°C to +150°C	
Input Voltage		-0.3V to V _{DD} + 0.3V	
Power Dissipation ⁽³⁾		Internally limited	
ESD Susceptibility ⁽⁴⁾		10.0kV	
ESD Susceptibility ⁽⁵⁾		500V	
Junction Temperature		150°C	
Soldering Information ⁽⁶⁾	Small Outline Package	Vapor Phase (60 seconds)	215°C
		Infrared (15 seconds)	220°C
Thermal Resistance	θ _{JC} (VSSOP)		56°C/W
	θ _{JA} (VSSOP)		210°C/W
	θ _{JC} (SOIC)		35°C/W
	θ _{JA} (SOIC)		170°C/W
	θ _{JC} (WSON)		15°C/W
	θ _{JA} (WSON)		117°C/W ⁽⁷⁾
	θ _{JA} (WSON)		150°C/W ⁽⁸⁾

- (1) **Absolute Maximum Ratings** indicate limits beyond which damage to the device may occur. **Operating Ratings** indicate conditions for which the device is functional, but do not ensure specific performance limits. state DC and AC electrical specifications under particular test conditions which ensure specific performance limits. This assumes that the device is within the Operating Ratings. Specifications are not ensured for parameters where no limit is given, however, the typical value is a good indication of device performance.
- (2) If Military/Aerospace specified devices are required, please contact the Texas Instruments Sales Office/ Distributors for availability and specifications.
- (3) The maximum power dissipation must be derated at elevated temperatures and is dictated by T_{JMAX}, θ_{JA}, and the ambient temperature T_A. The maximum allowable power dissipation is P_{DMAX} = (T_{JMAX} - T_A) / θ_{JA}. For the LM4908, T_{JMAX} = 150°C, and the typical junction-to-ambient thermal resistance, when board mounted, is 210°C/W for package MUA08A and 170°C/W for package M08A.
- (4) Human body model, 100pF discharged through a 1.5kΩ resistor.
- (5) Machine Model, 220pF–240pF discharged through all pins.
- (6) See <http://www.ti.com> for other methods of soldering surface mount devices.
- (7) The given θ_{JA} is for an LM4908 packaged in an LQB08A with the Exposed-DAP soldered to a printed circuit board copper pad with an area equivalent to that of the Exposed-DAP itself.
- (8) The given θ_{JA} is for an LM4908 packaged in an LQB08A with the Exposed-DAP not soldered to any printed circuit board copper.

OPERATING RATINGS

Temperature Range		
T _{MIN} ≤ T _A ≤ T _{MAX}		-40°C ≤ T _A ≤ 85°C
Supply Voltage		2.0V ≤ V _{DD} ≤ 5.5V

ELECTRICAL CHARACTERISTICS ^{(1) (2)}

The following specifications apply for V_{DD} = 5V unless otherwise specified, limits apply to T_A = 25°C.

Symbol	Parameter	Conditions	LM4908		Units (Limits)
			Typ ⁽³⁾	Limit ⁽⁴⁾	
V _{DD}	Supply Voltage			2.0	V (min)
				5.5	V (max)
I _{DD}	Supply Current	V _{IN} = 0V, I _O = 0A	1.6	3.0	mA (max)
P _{tot}	Total Power Dissipation	V _{IN} = 0V, I _O = 0A	8	16.5	mW (max)
V _{OS}	Input Offset Voltage	V _{IN} = 0V	5	50	mV (max)
I _{bias}	Input Bias Current		10		pA

- (1) All voltages are measured with respect to the ground pin, unless otherwise specified.
- (2) **Absolute Maximum Ratings** indicate limits beyond which damage to the device may occur. **Operating Ratings** indicate conditions for which the device is functional, but do not ensure specific performance limits. state DC and AC electrical specifications under particular test conditions which ensure specific performance limits. This assumes that the device is within the Operating Ratings. Specifications are not ensured for parameters where no limit is given, however, the typical value is a good indication of device performance.
- (3) Typicals are measured at 25°C and represent the parametric norm.
- (4) Tested limits are specified to TI's AOQL (Average Outgoing Quality Level). Datasheet min/max specification limits are specified by design, test, or statistical analysis.

ELECTRICAL CHARACTERISTICS ⁽¹⁾ ⁽²⁾ (continued)

The following specifications apply for $V_{DD} = 5V$ unless otherwise specified, limits apply to $T_A = 25^\circ C$.

Symbol	Parameter	Conditions	LM4908		Units (Limits)
			Typ ⁽³⁾	Limit ⁽⁴⁾	
V_{CM}	Common Mode Voltage		0		V
			4.3		V
G_V	Open-Loop Voltage Gain	$R_L = 5k\Omega$	67		dB
I_O	Max Output Current	THD+N < 0.1 %	70		mA
R_O	Output Resistance		0.1		Ω
V_O	Output Swing	$R_L = 32\Omega$, 0.1% THD+N, Min	.3		V
		$R_L = 32\Omega$, 0.1% THD+N, Max	4.7		
PSRR	Power Supply Rejection Ratio	$C_b = 1.0\mu F$, Vripple = 100mV _{pp} , f = 40Hz	90		dB
Crosstalk	Channel Separation	$R_L = 32\Omega$, f = 1kHz	82		dB
THD+N	Total Harmonic Distortion + Noise	f = 1 kHz			
		$R_L = 16\Omega$, $V_O = 3.5V_{pp}$ (at 0 dB)	0.05		%
			66		dB
		$R_L = 32\Omega$, $V_O = 3.5V_{pp}$ (at 0 dB)	0.05		%
			66		dB
SNR	Signal-to-Noise Ratio	$V_O = 3.5V_{pp}$ (at 0 dB)	100		dB
f_G	Unity Gain Frequency	Open Loop, $R_L = 5k\Omega$	25		MHz
P_O	Output Power	THD+N = 0.1%, f = 1 kHz			
		$R_L = 16\Omega$	120		mW
		$R_L = 32\Omega$	75	60	mW
		THD+N = 10%, f = 1 kHz			
		$R_L = 16\Omega$	157		mW
		$R_L = 32\Omega$	99		mW
C_I	Input Capacitance		3		pF
C_L	Load Capacitance			200	pF
SR	Slew Rate	Unity Gain Inverting	3		V/ μs

ELECTRICAL CHARACTERISTICS ⁽¹⁾ ⁽²⁾

The following specifications apply for $V_{DD} = 3.3V$ unless otherwise specified, limits apply to $T_A = 25^\circ C$.

Symbol	Parameter	Conditions	Conditions		Units (Limits)
			Typ ⁽³⁾	Limit ⁽⁴⁾	
I_{DD}	Supply Current	$V_{IN} = 0V$, $I_O = 0A$	1.4		mA (max)
V_{OS}	Input Offset Voltage	$V_{IN} = 0V$	5		mV (max)
P_O	Output Power	THD+N = 0.1%, f = 1 kHz			
		$R_L = 16\Omega$	43		mW
		$R_L = 32\Omega$	30		mW
		THD+N = 10%, f = 1 kHz			
		$R_L = 16\Omega$	61		mW
		$R_L = 32\Omega$	41		mW

- (1) All voltages are measured with respect to the ground pin, unless otherwise specified.
- (2) **Absolute Maximum Ratings** indicate limits beyond which damage to the device may occur. **Operating Ratings** indicate conditions for which the device is functional, but do not ensure specific performance limits. State DC and AC electrical specifications under particular test conditions which ensure specific performance limits. This assumes that the device is within the Operating Ratings. Specifications are not ensured for parameters where no limit is given, however, the typical value is a good indication of device performance.
- (3) Typical values are measured at $25^\circ C$ and represent the parametric norm.
- (4) Tested limits are specified to TI's AOQL (Average Outgoing Quality Level). Datasheet min/max specification limits are specified by design, test, or statistical analysis.

ELECTRICAL CHARACTERISTICS (1) (2)

 The following specifications apply for $V_{DD} = 2.6V$ unless otherwise specified, limits apply to $T_A = 25^\circ C$.

Symbol	Parameter	Conditions	Conditions		Units (Limits)
			Typ ⁽³⁾	Limit ⁽⁴⁾	
I_{DD}	Supply Current	$V_{IN} = 0V, I_O = 0A$	1.3		mA (max)
V_{OS}	Input Offset Voltage	$V_{IN} = 0V$	5		mV (max)
P_o	Output Power	THD+N = 0.1%, f = 1 kHz			
		$R_L = 16\Omega$	20		mW
		$R_L = 32\Omega$	16		mW
		THD+N = 10%, f = 1 kHz			
		$R_L = 16\Omega$	34		mW
		$R_L = 32\Omega$	24		mW

- (1) All voltages are measured with respect to the ground pin, unless otherwise specified.
- (2) [Absolute Maximum Ratings](#) indicate limits beyond which damage to the device may occur. [Operating Ratings](#) indicate conditions for which the device is functional, but do not ensure specific performance limits. state DC and AC electrical specifications under particular test conditions which ensure specific performance limits. This assumes that the device is within the Operating Ratings. Specifications are not ensured for parameters where no limit is given, however, the typical value is a good indication of device performance.
- (3) Typicals are measured at $25^\circ C$ and represent the parametric norm.
- (4) Tested limits are specified to TI's AOQL (Average Outgoing Quality Level). Datasheet min/max specification limits are specified by design, test, or statistical analysis.

EXTERNAL COMPONENTS DESCRIPTION

 (see [Figure 1](#))

Components	Functional Description
1. R_i	The inverting input resistance, along with R_f , set the closed-loop gain. R_i , along with C_i , form a high pass filter with $f_c = 1/(2\pi R_i C_i)$.
2. C_i	The input coupling capacitor blocks DC voltage at the amplifier's input terminals. C_i , along with R_i , create a highpass filter with $f_c = 1/(2\pi R_i C_i)$. See SELECTING PROPER EXTERNAL COMPONENTS for an explanation of determining the value of C_i .
3. R_f	The feedback resistance, along with R_i , set closed-loop gain.
4. C_S	This is the supply bypass capacitor. It provides power supply filtering. See APPLICATION INFORMATION for proper placement and selection of the supply bypass capacitor.
5. C_B	This is the half-supply bypass pin capacitor. It provides half-supply filtering. See SELECTING PROPER EXTERNAL COMPONENTS for information concerning proper placement and selection of C_B .
6. C_O	This is the output coupling capacitor. It blocks the DC voltage at the amplifier's output and forms a high pass filter with R_L at $f_o = 1/(2\pi R_L C_O)$
7. R_B	This is the resistor which forms a voltage divider that provides $1/2 V_{DD}$ to the non-inverting input of the amplifier.

TYPICAL PERFORMANCE CHARACTERISTICS

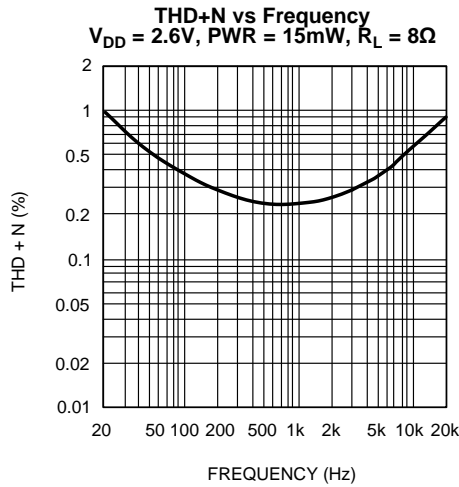

Figure 4.

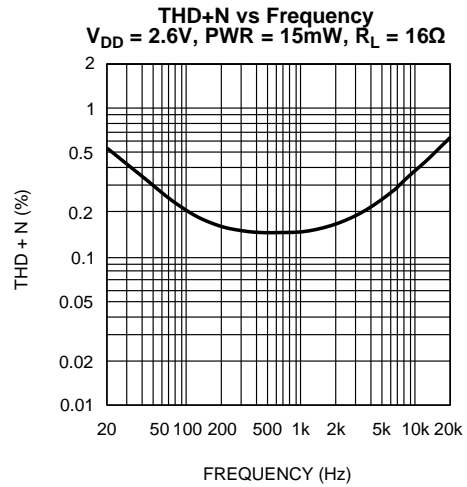

Figure 5.

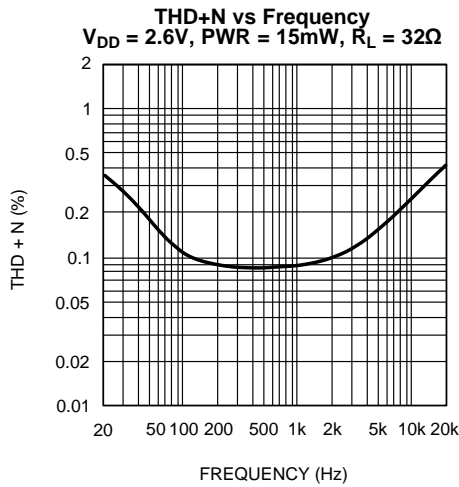

Figure 6.

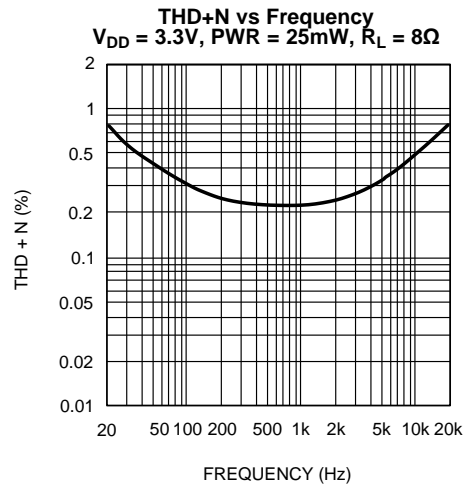

Figure 7.

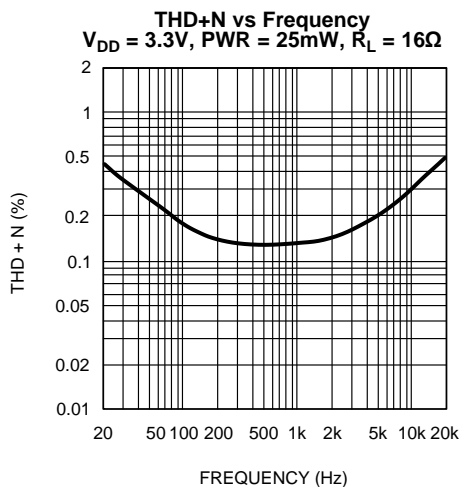

Figure 8.

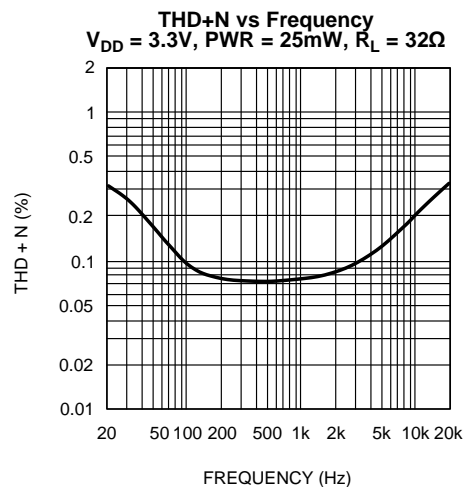

Figure 9.

TYPICAL PERFORMANCE CHARACTERISTICS (continued)

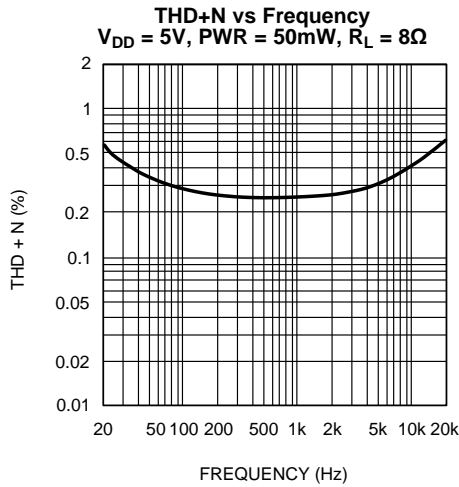

Figure 10.

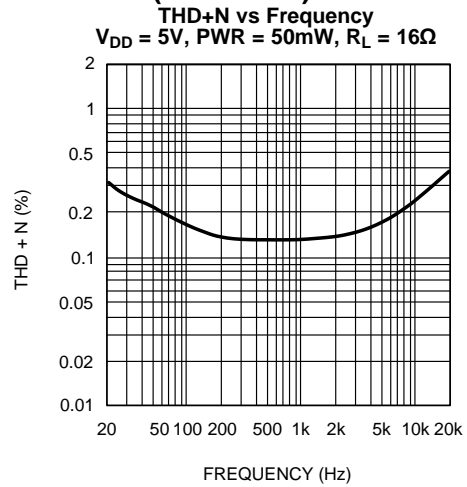

Figure 11.

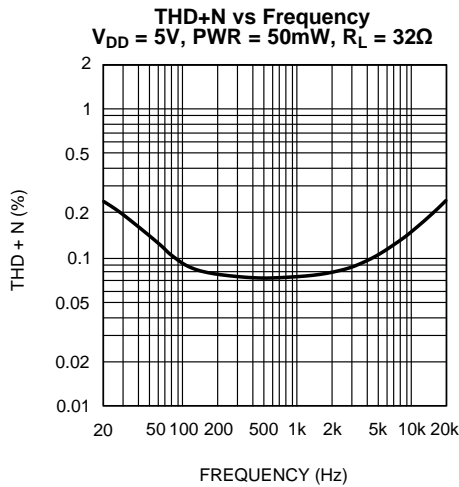

Figure 12.

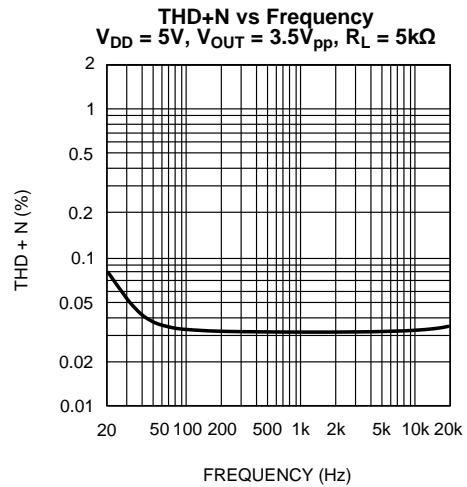

Figure 13.

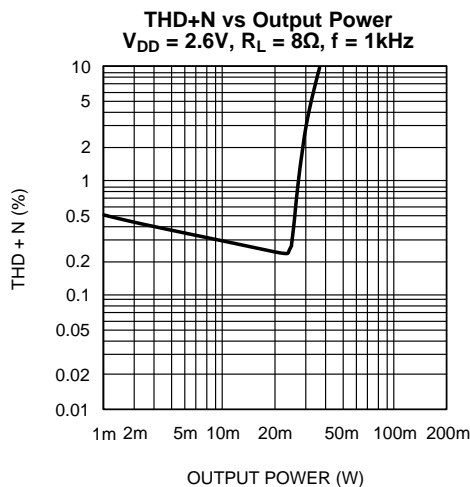

Figure 14.

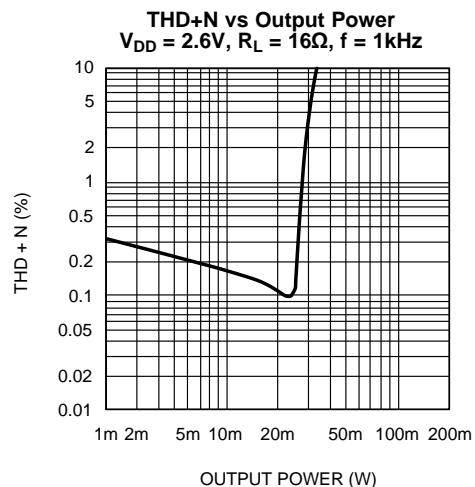

Figure 15.

TYPICAL PERFORMANCE CHARACTERISTICS (continued)

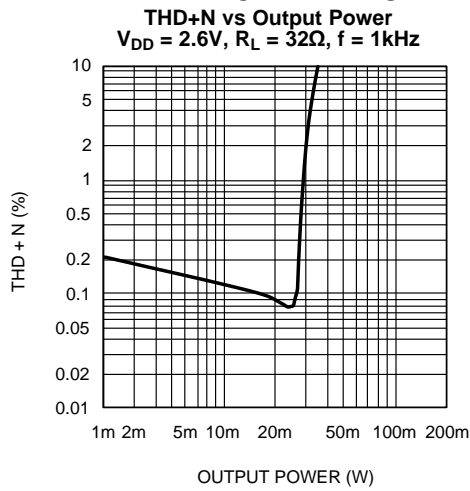

Figure 16.

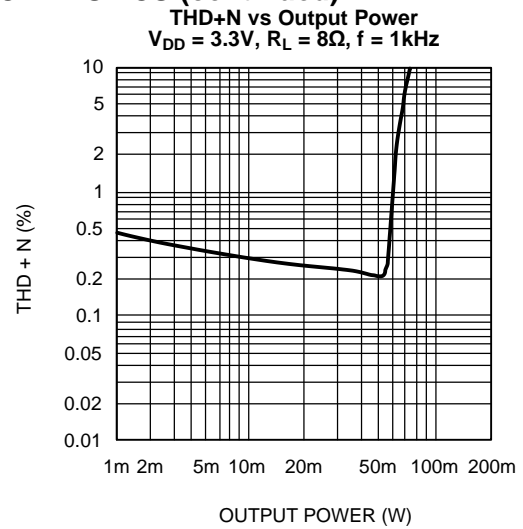

Figure 17.

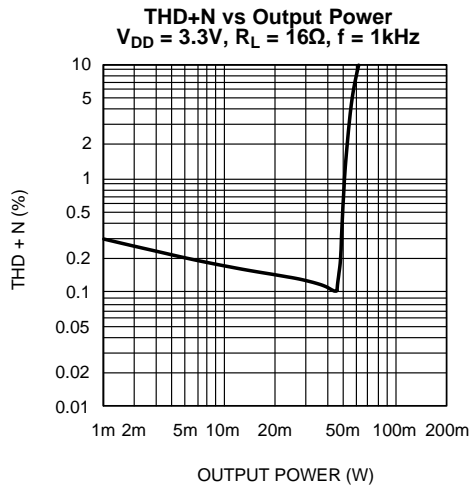

Figure 18.

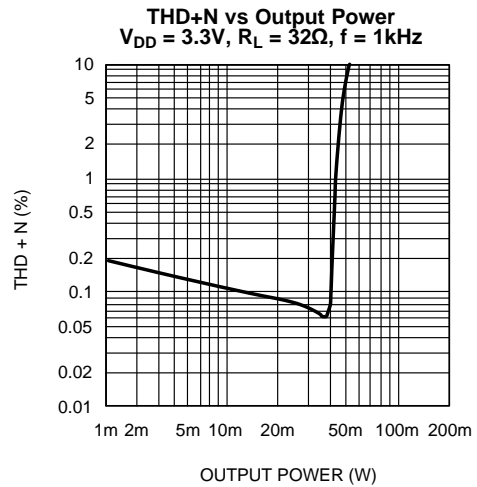

Figure 19.

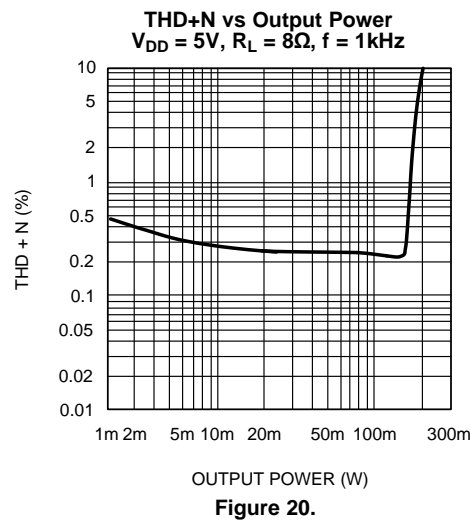

Figure 20.

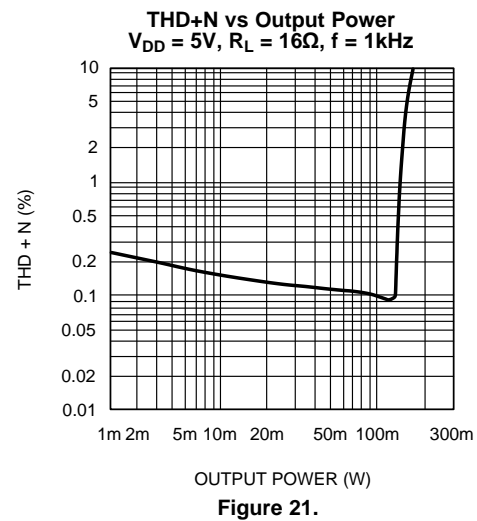

Figure 21.

TYPICAL PERFORMANCE CHARACTERISTICS (continued)

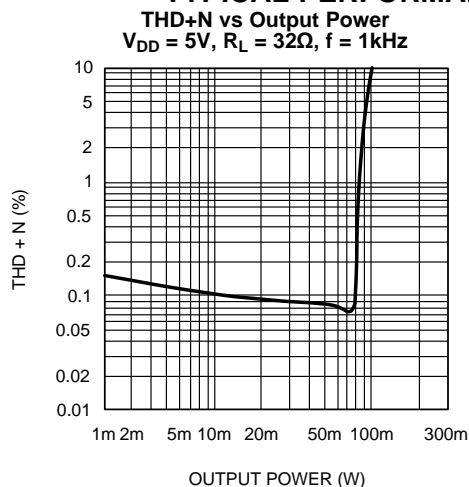

Figure 22.

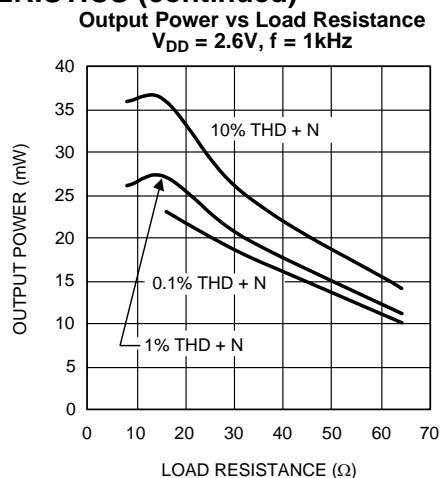

Figure 23.

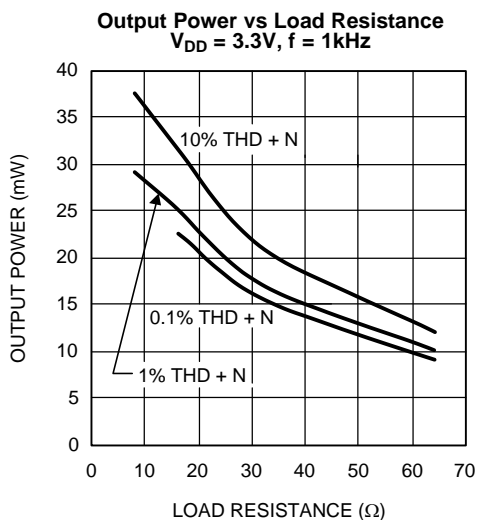

Figure 24.

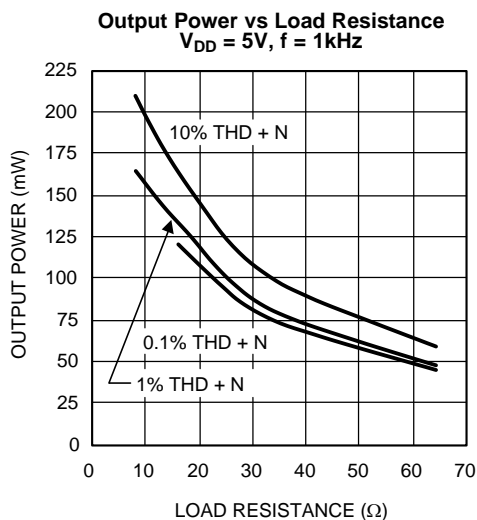

Figure 25.

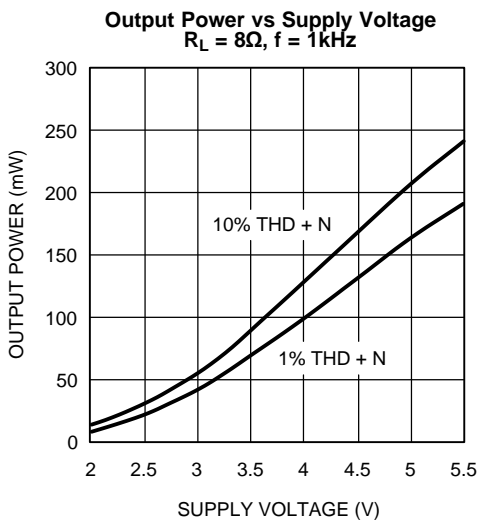

Figure 26.

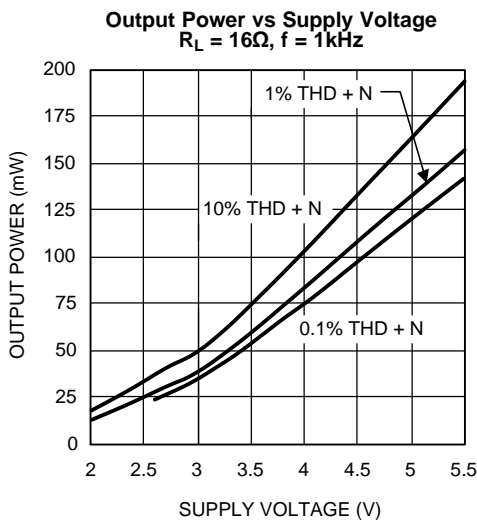

Figure 27.

TYPICAL PERFORMANCE CHARACTERISTICS (continued)

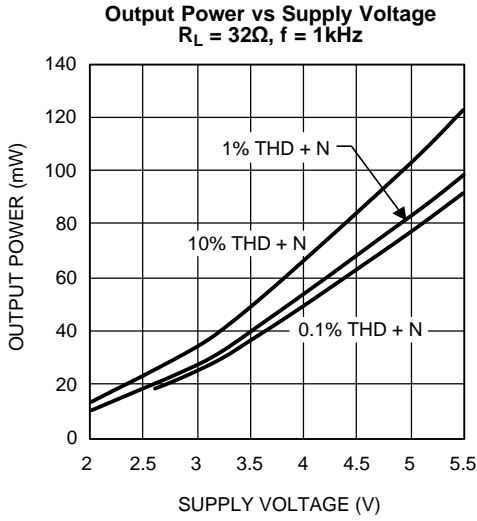

Figure 28.

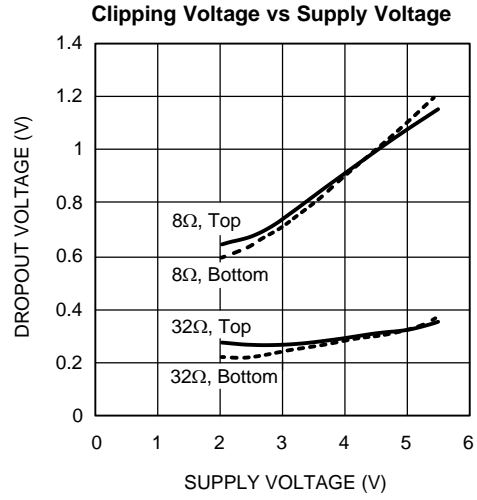

Figure 29.

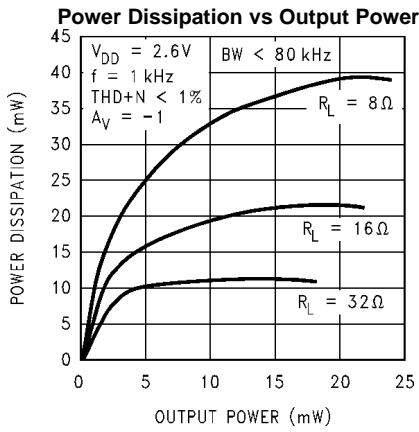

Figure 30.

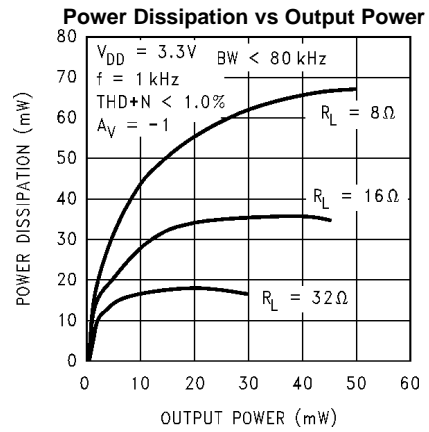

Figure 31.

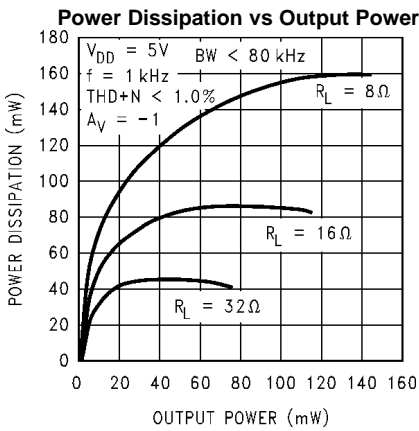

Figure 32.

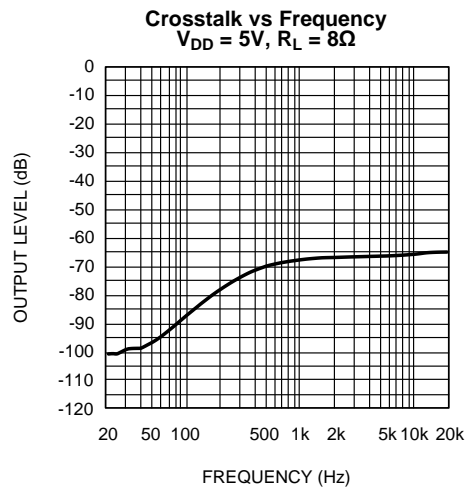

Figure 33.

TYPICAL PERFORMANCE CHARACTERISTICS (continued)

Crosstalk vs Frequency
 $V_{DD} = 5V, R_L = 32\Omega$

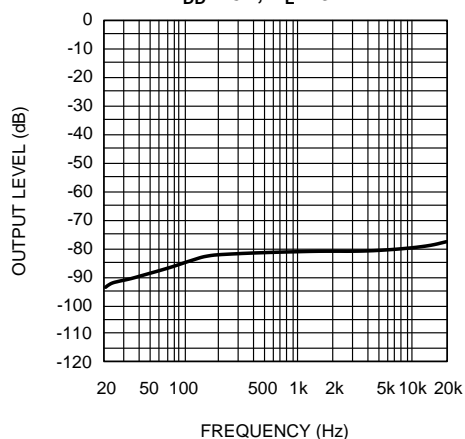

Figure 34.

Output Noise vs Frequency
 $V_{DD} = 5V, R_L = 32\Omega$

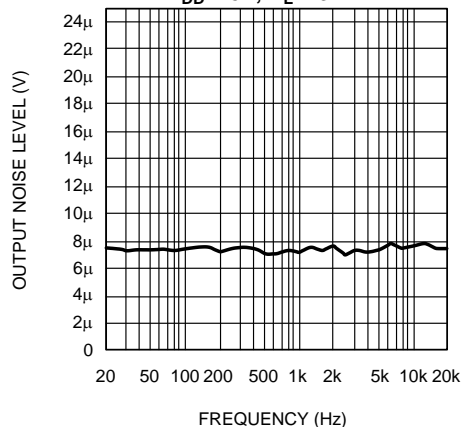

Figure 35.

PSRR vs Frequency
 $V_{DD} = 5V, R_L = 32\Omega, V_{RIPPLE} = 100mV_{pp}$
 Pins 3 and 5 directly driven, Inputs Floating

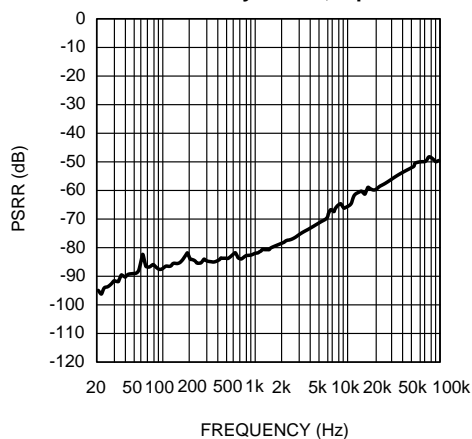

Figure 36.

PSRR vs Frequency
 $V_{DD} = 5V, R_L = 32\Omega, V_{RIPPLE} = 100mV_{pp}$
 Inputs Terminated

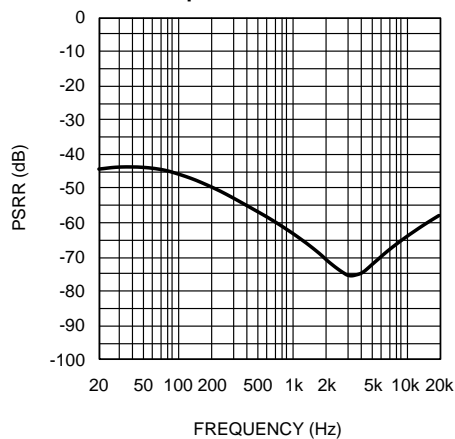

Figure 37.

Open Loop Frequency Response
 $V_{DD} = 5V, R_L = 8\Omega$

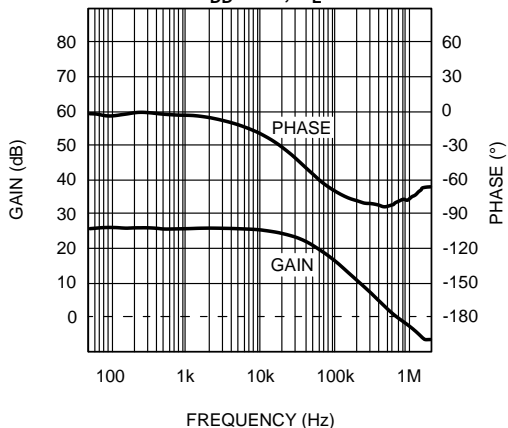

Figure 38.

Open Loop Frequency Response
 $V_{DD} = 5V, R_L = 32\Omega$

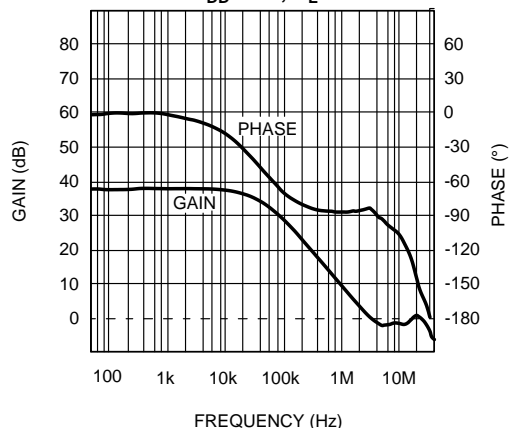

Figure 39.

TYPICAL PERFORMANCE CHARACTERISTICS (continued)

Open Loop Frequency Response
 $V_{DD} = 5V, R_L = 5k\Omega$

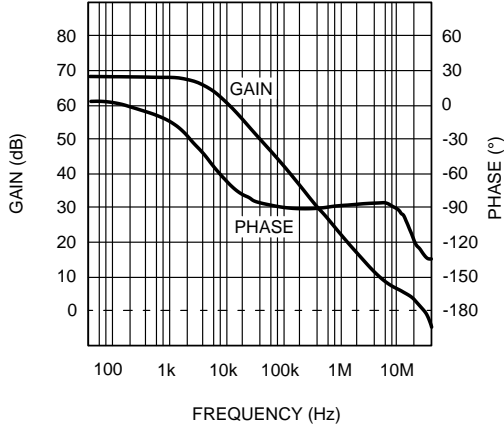

Figure 40.

Supply Current vs Supply Voltage (no Load)

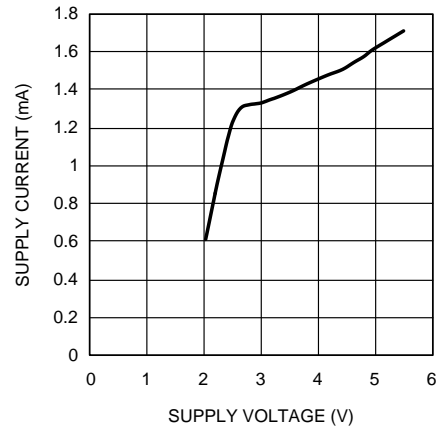

Figure 41.

Frequency Response vs Output Capacitor Size

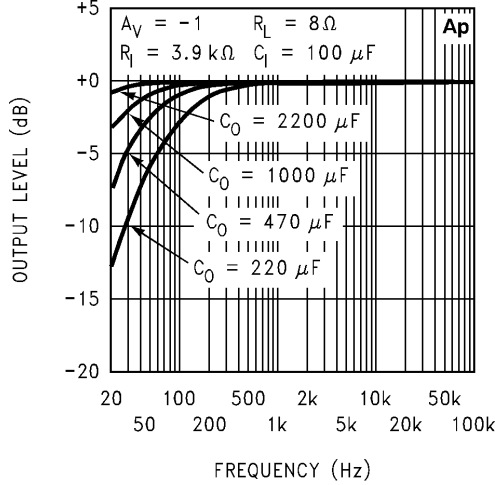

Figure 42.

Frequency Response vs Output Capacitor Size

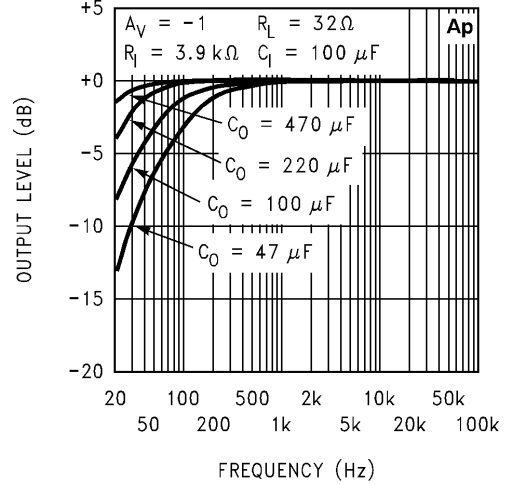

Figure 43.

Frequency Response vs Output Capacitor Size

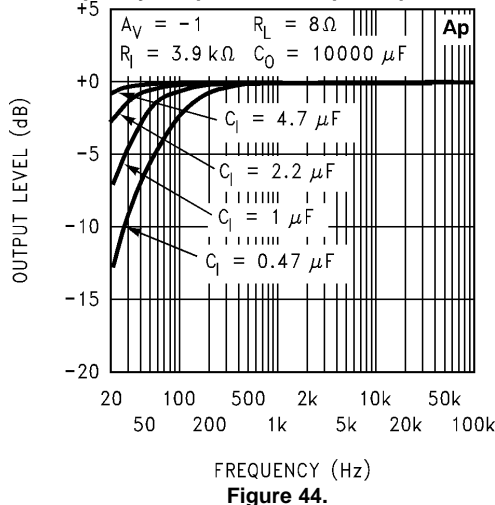

Figure 44.

Typical Application Frequency Response

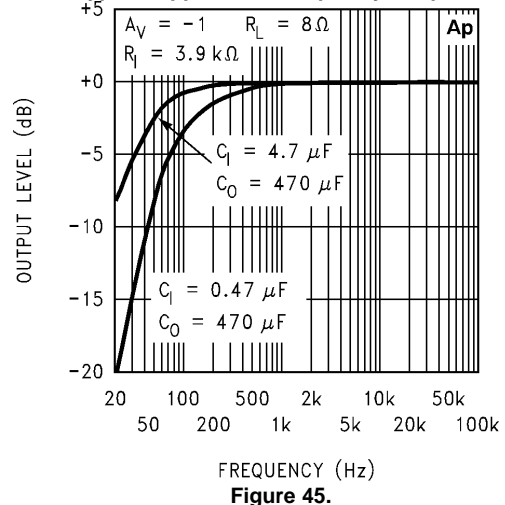

Figure 45.

TYPICAL PERFORMANCE CHARACTERISTICS (continued)

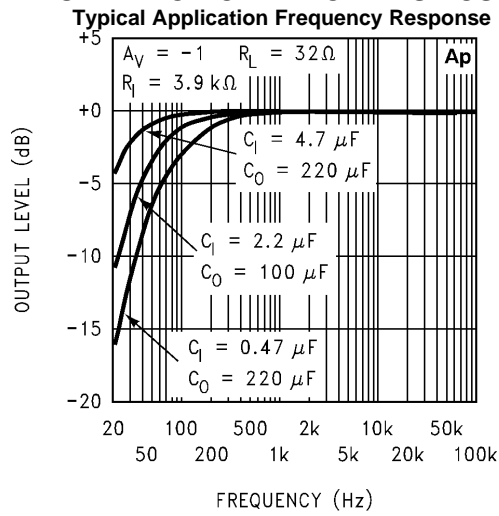

Figure 46.

APPLICATION INFORMATION

EXPOSED-DAP PACKAGE PCB MOUNTING CONSIDERATION

The LM4908's exposed-dap (die attach paddle) package (LQ) provides a low thermal resistance between the die and the PCB to which the part is mounted and soldered. This allows rapid heat transfer from the die to the surrounding PCB copper traces, ground plane, and surrounding air.

The LQ package should have its DAP soldered to a copper pad on the PCB. The DAP's PCB copper pad may be connected to a large plane of continuous unbroken copper. This plane forms a thermal mass, heat sink, and radiation area.

However, since the LM4908 is designed for headphone applications, connecting a copper plane to the DAP's PCB copper pad is not required. The LM4908's Power Dissipation vs Output Power Curve in the [TYPICAL PERFORMANCE CHARACTERISTICS](#) shows that the maximum power dissipated is just 45mW per amplifier with a 5V power supply and a 32Ω load.

Further detailed and specific information concerning PCB layout, fabrication, and mounting an LQ (WSON) package is available from Texas Instruments' Package Engineering Group under application note AN-1187 (literature number [SNOA401](#)).

POWER DISSIPATION

Power dissipation is a major concern when using any power amplifier and must be thoroughly understood to ensure a successful design. [Equation 1](#) states the maximum power dissipation point for a single-ended amplifier operating at a given supply voltage and driving a specified output load.

$$P_{\text{DMAX}} = (V_{\text{DD}})^2 / (2\pi^2 R_L) \quad (1)$$

Since the LM4908 has two operational amplifiers in one package, the maximum internal power dissipation point is twice that of the number which results from [Equation 1](#). Even with the large internal power dissipation, the LM4908 does not require heat sinking over a large range of ambient temperature. From [Equation 1](#), assuming a 5V power supply and a 32Ω load, the maximum power dissipation point is 40mW per amplifier. Thus the maximum package dissipation point is 80mW. The maximum power dissipation point obtained must not be greater than the power dissipation that results from [Equation 2](#):

$$P_{\text{DMAX}} = (T_{\text{JMAX}} - T_A) / \theta_{\text{JA}} \quad (2)$$

For package MUA08A, $\theta_{\text{JA}} = 210^\circ\text{C/W}$. $T_{\text{JMAX}} = 150^\circ\text{C}$ for the LM4908. Depending on the ambient temperature, T_A , of the system surroundings, [Equation 2](#) can be used to find the maximum internal power dissipation supported by the IC packaging. If the result of [Equation 1](#) is greater than that of [Equation 2](#), then either the supply voltage must be decreased, the load impedance increased or T_A reduced. For the typical application of a 5V power supply, with a 32Ω load, the maximum ambient temperature possible without violating the maximum junction temperature is approximately 133.2°C provided that device operation is around the maximum power dissipation point. Power dissipation is a function of output power and thus, if typical operation is not around the maximum power dissipation point, the ambient temperature may be increased accordingly. Refer to the [TYPICAL PERFORMANCE CHARACTERISTICS](#) curves for power dissipation information for lower output powers.

POWER SUPPLY BYPASSING

As with any power amplifier, proper supply bypassing is critical for low noise performance and high power supply rejection. Applications that employ a 5V regulator typically use a 10μF in parallel with a 0.1μF filter capacitors to stabilize the regulator's output, reduce noise on the supply line, and improve the supply's transient response. However, their presence does not eliminate the need for a local 0.1μF supply bypass capacitor, C_S , connected between the LM4908's supply pins and ground. Keep the length of leads and traces that connect capacitors between the LM4908's power supply pin and ground as short as possible. Connecting a 1.0μF capacitor, C_B , between the IN A(+) / IN B(+) node and ground improves the internal bias voltage's stability and improves the amplifier's PSRR. The PSRR improvements increase as the bypass pin capacitor value increases. Too large, however, increases the amplifier's turn-on time. The selection of bypass capacitor values, especially C_B , depends on desired PSRR requirements, click and pop performance (as explained in [SELECTING PROPER EXTERNAL COMPONENTS](#)), system cost, and size constraints.

SELECTING PROPER EXTERNAL COMPONENTS

Optimizing the LM4908's performance requires properly selecting external components. Though the LM4908 operates well when using external components with wide tolerances, best performance is achieved by optimizing component values.

The LM4908 is unity-gain stable, giving a designer maximum design flexibility. The gain should be set to no more than a given application requires. This allows the amplifier to achieve minimum THD+N and maximum signal-to-noise ratio. These parameters are compromised as the closed-loop gain increases. However, low gain demands input signals with greater voltage swings to achieve maximum output power. Fortunately, many signal sources such as audio CODECs have outputs of $1V_{RMS}$ ($2.83V_{P-P}$). Please refer to [AUDIO POWER AMPLIFIER DESIGN](#) for more information on selecting the proper gain.

Input and Output Capacitor Value Selection

Amplifying the lowest audio frequencies requires high value input and output coupling capacitors (C_I and C_O in [Figure 1](#)). A high value capacitor can be expensive and may compromise space efficiency in portable designs. In many cases, however, the speakers used in portable systems, whether internal or external, have little ability to reproduce signals below 150Hz. Applications using speakers with this limited frequency response reap little improvement by using high value input and output capacitors.

Besides affecting system cost and size, C_I has an effect on the LM4908's click and pop performance. The magnitude of the pop is directly proportional to the input capacitor's size. Thus, pops can be minimized by selecting an input capacitor value that is no higher than necessary to meet the desired $-3dB$ frequency.

As shown in [Figure 1](#), the input resistor, R_I and the input capacitor, C_I , produce a $-3dB$ high pass filter cutoff frequency that is found using [Equation 3](#). In addition, the output load R_L , and the output capacitor C_O , produce a $-3dB$ high pass filter cutoff frequency defined by [Equation 4](#).

$$f_{i-3db} = 1/2\pi R_I C_I \quad (3)$$

$$f_{o-3db} = 1/2\pi R_L C_O \quad (4)$$

Also, careful consideration must be taken in selecting a certain type of capacitor to be used in the system. Different types of capacitors (tantalum, electrolytic, ceramic) have unique performance characteristics and may affect overall system performance.

Bypass Capacitor Value

Besides minimizing the input capacitor size, careful consideration should be paid to the value of the bypass capacitor, C_B . Since C_B determines how fast the LM4908 settles to quiescent operation, its value is critical when minimizing turn-on pops. The slower the LM4908's outputs ramp to their quiescent DC voltage (nominally $1/2 V_{DD}$), the smaller the turn-on pop. Choosing C_B equal to $1.0\mu F$ or larger, will minimize turn-on pops. As discussed above, choosing C_I no larger than necessary for the desired bandwidth helps minimize clicks and pops.

AUDIO POWER AMPLIFIER DESIGN

Design a Dual 70mW/32Ω Audio Amplifier

Given:

Power Output	70mW
Load Impedance	32Ω
Input Level	1Vrms (max)
Input Impedance	20kΩ
Bandwidth	100Hz–20kHz ± 0.50dB

The design begins by specifying the minimum supply voltage necessary to obtain the specified output power. One way to find the minimum supply voltage is to use the Output Power vs Supply Voltage curve in [TYPICAL PERFORMANCE CHARACTERISTICS](#). Another way, using [Equation 5](#), is to calculate the peak output voltage necessary to achieve the desired output power for a given load impedance. To account for the amplifier's dropout voltage, two additional voltages, based on the Dropout Voltage vs Supply Voltage in the [TYPICAL PERFORMANCE CHARACTERISTICS](#) curves, must be added to the result obtained by [Equation 5](#). For a single-ended application, the result is [Equation 6](#).

$$V_{\text{opeak}} = \sqrt{(2R_L P_O)} \quad (5)$$

$$V_{\text{DD}} \geq (2V_{\text{OPEAK}} + (V_{\text{ODTOP}} + V_{\text{ODBOT}})) \quad (6)$$

The [Output Power vs Supply Voltage](#) graph for a 32Ω load indicates a minimum supply voltage of 4.8V. This is easily met by the commonly used 5V supply voltage. The additional voltage creates the benefit of headroom, allowing the LM4908 to produce peak output power in excess of 70mW without clipping or other audible distortion. The choice of supply voltage must also not create a situation that violates maximum power dissipation as explained above in [POWER DISSIPATION](#). Remember that the maximum power dissipation point from [Equation 1](#) must be multiplied by two since there are two independent amplifiers inside the package. Once the power dissipation equations have been addressed, the required gain can be determined from [Equation 7](#).

$$A_V \geq \sqrt{(P_O R_L)} / (V_{\text{IN}}) = V_{\text{orms}} / V_{\text{inrms}} \quad (7)$$

Thus, a minimum gain of 1.497 allows the LM4908 to reach full output swing and maintain low noise and THD+N performance. For this example, let $A_V = 1.5$.

The amplifiers overall gain is set using the input (R_i) and feedback (R_f) resistors. With the desired input impedance set at 20kΩ, the feedback resistor is found using [Equation 8](#).

$$A_V = R_f / R_i \quad (8)$$

The value of R_f is 30kΩ.

The last step in this design is setting the amplifier's –3db frequency bandwidth. To achieve the desired ±0.25dB pass band magnitude variation limit, the low frequency response must extend to at least one-fifth the lower bandwidth limit and the high frequency response must extend to at least five times the upper bandwidth limit. The gain variation for both response limits is 0.17dB, well within the ±0.25dB desired limit. The results are an

$$f_L = 100\text{Hz}/5 = 20\text{Hz} \quad (9)$$

and a

$$f_H = 20\text{kHz} \cdot 5 = 100\text{kHz} \quad (10)$$

As stated in [EXTERNAL COMPONENTS DESCRIPTION](#), both R_i in conjunction with C_i , and C_o with R_L , create first order highpass filters. Thus to obtain the desired low frequency response of 100Hz within ±0.5dB, both poles must be taken into consideration. The combination of two single order filters at the same frequency forms a second order response. This results in a signal which is down 0.34dB at five times away from the single order filter –3dB point. Thus, a frequency of 20Hz is used in the following equations to ensure that the response is better than 0.5dB down at 100Hz.

$$C_i \geq 1 / (2\pi \cdot 20 \text{ k}\Omega \cdot 20 \text{ Hz}) = 0.397\mu\text{F}; \text{ use } 0.39\mu\text{F}. \quad (11)$$

$$C_o \geq 1 / (2\pi \cdot 32\Omega \cdot 20 \text{ Hz}) = 249\mu\text{F}; \text{ use } 330\mu\text{F}. \quad (12)$$

The high frequency pole is determined by the product of the desired high frequency pole, f_H , and the closed-loop gain, A_V . With a closed-loop gain of 1.5 and $f_H = 100\text{kHz}$, the resulting $\text{GBWP} = 150\text{kHz}$ which is much smaller than the LM4908's GBWP of 3MHz . This figure displays that if a designer has a need to design an amplifier with a higher gain, the LM4908 can still be used without running into bandwidth limitations.

Demonstration Board Layout

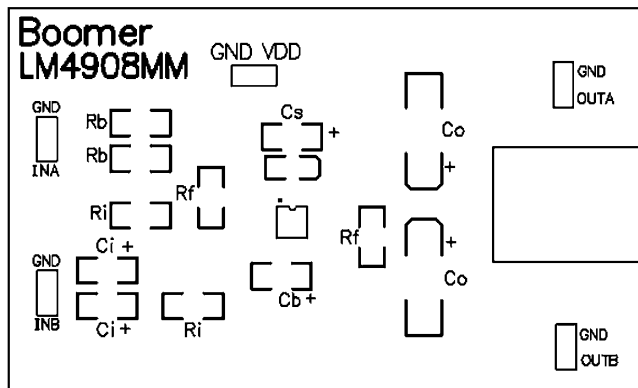

Figure 47. Recommended VSSOP Board Layout: Top Overlay

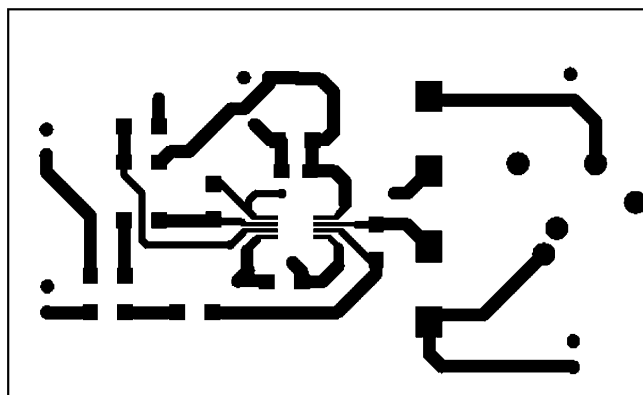

Figure 48. Recommended VSSOP Board Layout: Top Layer

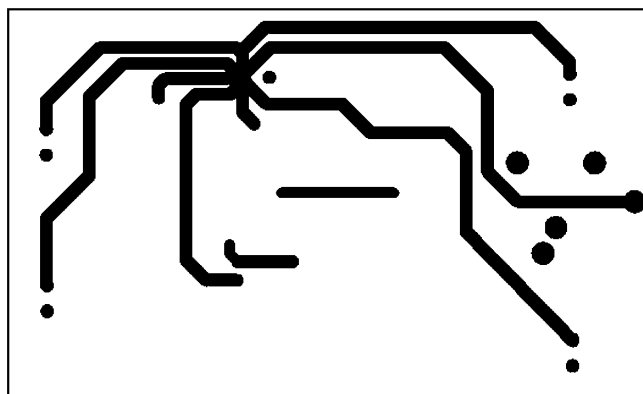

Figure 49. Recommended VSSOP Board Layout: Bottom Layer

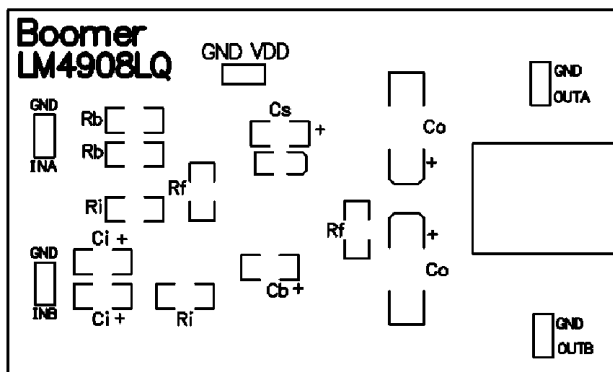

Figure 50. Recommended LQ Board Layout:
Top Overlay

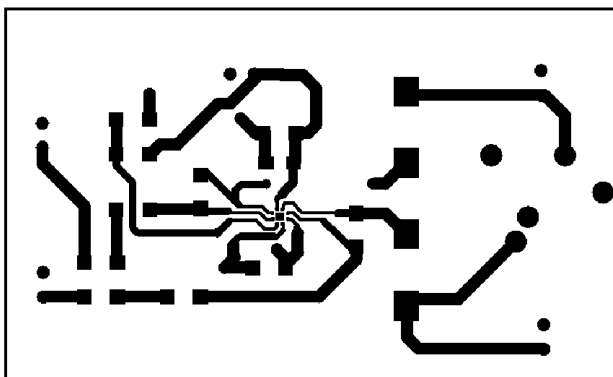

Figure 51. Recommended LQ Board Layout:
Top Layer

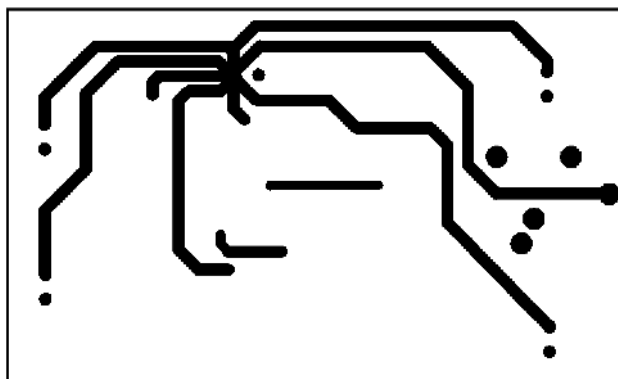

Figure 52. Recommended LQ Board Layout:
Bottom Layer

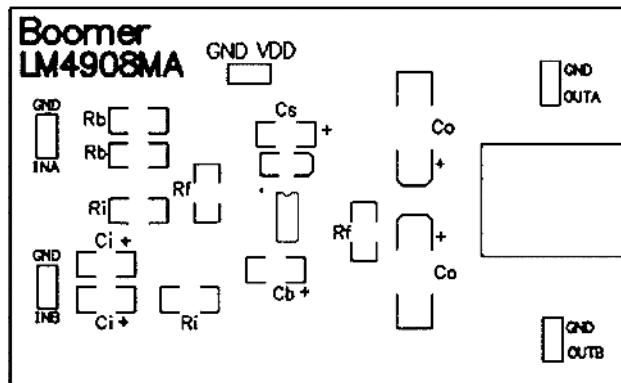

Figure 53. Recommended MA Board Layout:
Top Overlay

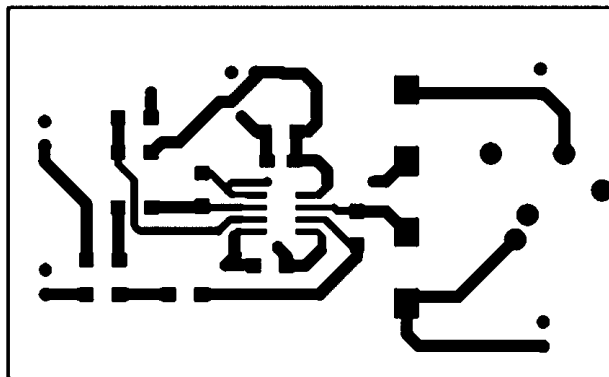

Figure 54. Recommended MA Board Layout:
Top Layer

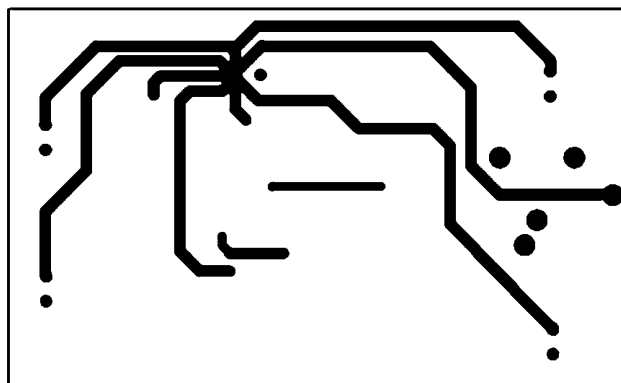

Figure 55. Recommended MA Board Layout:
Bottom Layer

LM4908 MDC MWC Dual 120MW Headphone Amplifier

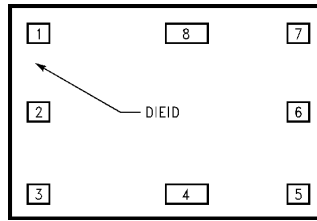

Figure 56. Die Layout (A - Step)

Table 1. DIE/WAFER CHARACTERISTICS

Fabrication Attributes		General Die Information	
Physical Die Identification	LM4908A	Bond Pad Opening Size (min)	70µm x 70µm
Die Step	A	Bond Pad Metalization	ALUMINUM
Physical Attributes		Passivation	NITRIDE
Wafer Diameter	150mm	Back Side Metal	BARE BACK
Dise Size (Drawn)	889µm x 622µm 35.0mils x 24.5mils	Back Side Connection	Floating
Thickness	216µm Nominal		
Min Pitch	216µm Nominal		

Special Assembly Requirements:

Note: Actual die size is rounded to the nearest micron.

Die Bond Pad Coordinate Locations (A - Step)

(Referenced to die center, coordinates in µm) NC = No Connection, N.U. = Not Used

SIGNAL NAME	PAD# NUMBER	X/Y COORDINATES		PAD SIZE		
		X	Y	X		Y
INPUT B+	1	-367	232	70	x	70
INPUT B-	2	-367	15	70	x	70
OUTPUT B	3	-367	-232	70	x	70
VDD	4	35	-232	155	x	70
OUTPUT A	5	367	-232	70	x	70
INPUT A-	6	367	15	70	x	70
INPUT A+	7	367	232	70	x	70
GND	8	68	232	155	x	70

REVISION HISTORY

Changes from Revision B (May 2013) to Revision C	Page
<ul style="list-style-type: none">Changed layout of National Data Sheet to TI format	20

IMPORTANT NOTICE

Texas Instruments Incorporated and its subsidiaries (TI) reserve the right to make corrections, enhancements, improvements and other changes to its semiconductor products and services per JESD46, latest issue, and to discontinue any product or service per JESD48, latest issue. Buyers should obtain the latest relevant information before placing orders and should verify that such information is current and complete. All semiconductor products (also referred to herein as "components") are sold subject to TI's terms and conditions of sale supplied at the time of order acknowledgment.

TI warrants performance of its components to the specifications applicable at the time of sale, in accordance with the warranty in TI's terms and conditions of sale of semiconductor products. Testing and other quality control techniques are used to the extent TI deems necessary to support this warranty. Except where mandated by applicable law, testing of all parameters of each component is not necessarily performed.

TI assumes no liability for applications assistance or the design of Buyers' products. Buyers are responsible for their products and applications using TI components. To minimize the risks associated with Buyers' products and applications, Buyers should provide adequate design and operating safeguards.

TI does not warrant or represent that any license, either express or implied, is granted under any patent right, copyright, mask work right, or other intellectual property right relating to any combination, machine, or process in which TI components or services are used. Information published by TI regarding third-party products or services does not constitute a license to use such products or services or a warranty or endorsement thereof. Use of such information may require a license from a third party under the patents or other intellectual property of the third party, or a license from TI under the patents or other intellectual property of TI.

Reproduction of significant portions of TI information in TI data books or data sheets is permissible only if reproduction is without alteration and is accompanied by all associated warranties, conditions, limitations, and notices. TI is not responsible or liable for such altered documentation. Information of third parties may be subject to additional restrictions.

Resale of TI components or services with statements different from or beyond the parameters stated by TI for that component or service voids all express and any implied warranties for the associated TI component or service and is an unfair and deceptive business practice. TI is not responsible or liable for any such statements.

Buyer acknowledges and agrees that it is solely responsible for compliance with all legal, regulatory and safety-related requirements concerning its products, and any use of TI components in its applications, notwithstanding any applications-related information or support that may be provided by TI. Buyer represents and agrees that it has all the necessary expertise to create and implement safeguards which anticipate dangerous consequences of failures, monitor failures and their consequences, lessen the likelihood of failures that might cause harm and take appropriate remedial actions. Buyer will fully indemnify TI and its representatives against any damages arising out of the use of any TI components in safety-critical applications.

In some cases, TI components may be promoted specifically to facilitate safety-related applications. With such components, TI's goal is to help enable customers to design and create their own end-product solutions that meet applicable functional safety standards and requirements. Nonetheless, such components are subject to these terms.

No TI components are authorized for use in FDA Class III (or similar life-critical medical equipment) unless authorized officers of the parties have executed a special agreement specifically governing such use.

Only those TI components which TI has specifically designated as military grade or "enhanced plastic" are designed and intended for use in military/aerospace applications or environments. Buyer acknowledges and agrees that any military or aerospace use of TI components which have **not** been so designated is solely at the Buyer's risk, and that Buyer is solely responsible for compliance with all legal and regulatory requirements in connection with such use.

TI has specifically designated certain components as meeting ISO/TS16949 requirements, mainly for automotive use. In any case of use of non-designated products, TI will not be responsible for any failure to meet ISO/TS16949.

Products

Audio	www.ti.com/audio
Amplifiers	amplifier.ti.com
Data Converters	dataconverter.ti.com
DLP® Products	www.dlp.com
DSP	dsp.ti.com
Clocks and Timers	www.ti.com/clocks
Interface	interface.ti.com
Logic	logic.ti.com
Power Mgmt	power.ti.com
Microcontrollers	microcontroller.ti.com
RFID	www.ti-rfid.com
OMAP Applications Processors	www.ti.com/omap
Wireless Connectivity	www.ti.com/wirelessconnectivity

Applications

Automotive and Transportation	www.ti.com/automotive
Communications and Telecom	www.ti.com/communications
Computers and Peripherals	www.ti.com/computers
Consumer Electronics	www.ti.com/consumer-apps
Energy and Lighting	www.ti.com/energy
Industrial	www.ti.com/industrial
Medical	www.ti.com/medical
Security	www.ti.com/security
Space, Avionics and Defense	www.ti.com/space-avionics-defense
Video and Imaging	www.ti.com/video

TI E2E Community

e2e.ti.com