

**ebm-papst St. Georgen GmbH & Co. KG**

Hermann-Papst-Str. 1  
 D-78112 St. Georgen  
 Phone +49 (0) 7724 81-0  
 Fax +49 (0) 7724 81-1309  
 info2@de.ebmpapst.com  
 www.ebmpapst.com

**Nominal data**

Type	5218 NN	
Nominal voltage	VDC	48
Nominal voltage range	VDC	36 .. 56
Speed (rpm)	min <sup>-1</sup>	3150
Power consumption	W	6.2
Min. ambient temperature	°C	-20
Max. ambient temperature	°C	70
Air flow	m <sup>3</sup> /h	216
Sound power level	B	5.6
Sound pressure level	dB(A)	46

ml = Max. load · me = Max. efficiency · fa = Free air · cs = Customer specification · ce = Customer equipment  
 Subject to change



**Technical description**

<b>General description</b>	Power consumption when wide open; these values may be considerably higher at the operating point.
<b>Housing material</b>	Glass-fiber reinforced PBT plastic
<b>Impeller material</b>	Glass-fiber reinforced PA plastic
<b>Weight</b>	0.310 kg
<b>Dimensions</b>	127 x 127 x 38 mm
<b>Airflow direction</b>	Exhaust over struts
<b>Direction of rotation</b>	Counterclockwise, viewed toward rotor
<b>Storage</b>	Ball bearing
<b>Service life L10 at 40 °C</b>	57500 h
<b>Service life L10 at maximum temperature</b>	32500 h
<b>Cable</b>	Leads AWG 22, TR 64, stripped and tin-plated.
<b>Motor protection</b>	Protection against reverse polarity and blocked rotor.
<b>Locked-rotor protection</b>	With electronic locked-rotor and overload protection
<b>Approval</b>	VDE, CSA, UL, CE
<b>Option</b>	Vario-Pro fan

## Product drawing

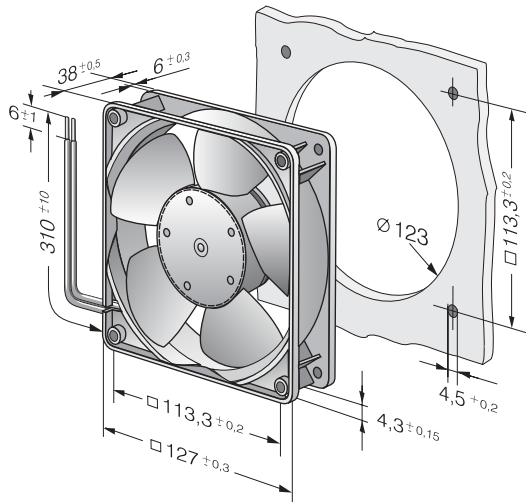

Curves: Air performance

