

1438299-2 ✓ ACTIVE

AMP | [Get .64 Connector System](#)

TE Internal #: 1438299-2

Automotive Terminals, Tab, Mating Tab Width 1 mm [.039 in], Tab Thickness .64 mm [.025 in], 24 – 22 AWG Wire Size, Get .64 Connector System

[View on TE.com >](#)



Terminals & Splices > Automotive Terminals > GET .64 CONNECTOR SYSTEM, RECEPT AND TAB



Terminal Type: **Tab**

Mating Tab Width: **1 mm [.039 in]**

Mating Tab Thickness: **.64 mm [.025 in]**

Terminal Transmits: **0 – 24 A (Low Power)**

Wire Size: **24 – 22 AWG**

[All GET .64 CONNECTOR SYSTEM, RECEPT AND TAB \(29\)](#)

Features

Product Type Features

Sealable	No
Primary Locking Feature	Clean Body

Contact Features

Contact Size	1mm
Contact Fabrication	Stamped & Formed
Wire Contact Termination Area Plating Material	Gold
Typical Current Rating	9 A
Crimp Type	F-Crimp
Terminal Type	Tab
Mating Tab Width	1 mm[.039 in]
Mating Tab Thickness	.64 mm[.025 in]
Interface Plating	Tin (Sn)

Termination Features

Termination Method to Wire & Cable	Crimp
Product Terminates To	Wire

Dimensions

Compatible Insulation Diameter Range	1.1 – 1.65 mm[.043 – .065 in]
--------------------------------------	-------------------------------



Wire Size	.22 – .35 mm ²
Wire Size Search	22 AWG, 23 AWG, 24 AWG

Usage Conditions

Insulation Option	Uninsulated
Operating Temperature (Max)	80 °C, 85 °C, 90 °C, 100 °C, 105 °C, 110 °C, 120 °C, 125 °C[176 °F][185 °F][194 °F][212 °F][221 °F][230 °F][248 °F][257 °F]
Operating Temperature Range	-40 – 125 °C[-40 – 257 °F]

Operation/Application

Compatible With Wire Base Material	Copper
------------------------------------	--------

Industry Standards

Agency/Standard	SAE/USCAR-2, USCAR-21
-----------------	-----------------------

Packaging Features

Packaging Quantity	11000
Packaging Method	Reel

Other

Terminal Transmits	0 – 24 A (Low Power)
--------------------	----------------------

Product Compliance

[For compliance documentation, visit the product page on TE.com>](#)

EU RoHS Directive 2011/65/EU	Compliant
EU ELV Directive 2000/53/EC	Compliant
China RoHS 2 Directive MIIT Order No 32, 2016	No Restricted Materials Above Threshold
EU REACH Regulation (EC) No. 1907/2006	Current ECHA Candidate List: JUNE 2023 (235) Candidate List Declared Against: JUNE 2023 (235) Does not contain REACH SVHC
Halogen Content	Low Halogen - Br, Cl, F, I < 900 ppm per homogenous material. Also BFR/CFR/PVC Free
Solder Process Capability	Not applicable for solder process capability

Product Compliance Disclaimer

This information is provided based on reasonable inquiry of our suppliers and represents our current actual knowledge based on the information they provided. This information is subject to change. The part numbers that TE has identified as



EU RoHS compliant have a maximum concentration of 0.1% by weight in homogenous materials for lead, hexavalent chromium, mercury, PBB, PBDE, DBP, BBP, DEHP, DIBP, and 0.01% for cadmium, or qualify for an exemption to these limits as defined in the Annexes of Directive 2011/65/EU (RoHS2). Finished electrical and electronic equipment products will be CE marked as required by Directive 2011/65/EU. Components may not be CE marked. Additionally, the part numbers that TE has identified as EU ELV compliant have a maximum concentration of 0.1% by weight in homogenous materials for lead, hexavalent chromium, and mercury, and 0.01% for cadmium, or qualify for an exemption to these limits as defined in the Annexes of Directive 2000/53/EC (ELV). Regarding the REACH Regulation, the information TE provides on SVHC in articles for this part number is based on the latest European Chemicals Agency (ECHA) 'Guidance on requirements for substances in articles' posted at this URL: <https://echa.europa.eu/guidance-documents/guidance-on-reach>

Compatible Parts



TE Part # 2305570-1
Strip Terminal Cutter-Side Feed-No Crimp



TE Part # 1393367-2
GET-SOCKET TERMINAL, SILVER VE



TE Part # 2151540-1
OCEAN_2.0_APPLICATOR-S-055F0700



TE Part # 2-2151540-1
OCEAN_2.0_APPLICATOR-S-055F0700



TE Part # 2-2151540-2
OCEAN_2.0_APPLICATOR-S-055F0700



TE Part # 2151540-2
OCEAN_2.0_APPLICATOR-S-055F0700



TE Part # 7-2151540-1
OCEAN_2.0_APPLICATOR-S-055F0700



TE Part # 7-2151540-2
OCEAN_2.0_APPLICATOR-S-055F0700



TE Part # 7-2151540-7
OCEAN_2.0_SPARE_PART_KIT-055F0700



TE Part # 2321456-1
L663 WIRING HARNESS HIGH SPEC



TE Part # 3-2151540-2
OCEAN_2.0_APPLICATOR-S-055F0700



TE Part # 6-1393462-4
GET-A HAND CRIMPING PLIERS

Also in the Series | Get .64 Connector System



Automotive Connector Caps & Covers (7)



Automotive Housings(118)

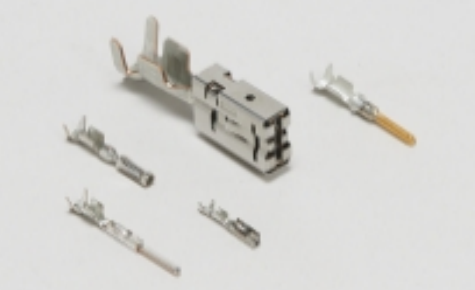

Automotive Terminals(30)



Insertion & Extraction Tools(1)



PCB Headers & Receptacles(1)

Customers Also Bought



TE Part #1563190-1
2POS,TAB 1.6 X 0.6,TAB HSG,COD

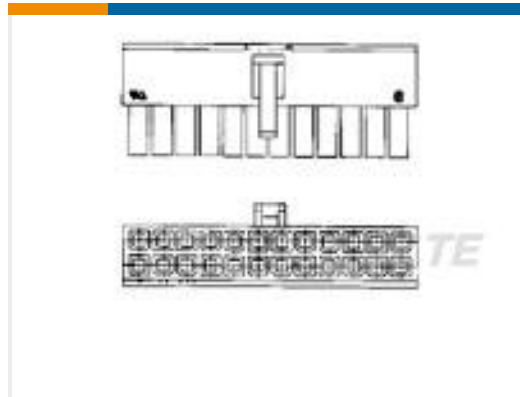

TE Part #1-1586765-2
12P RCPT VAL-U-LOK GW



TE Part #1924639-2
1X8 FEMALE ASSY KEY D, LP LATC

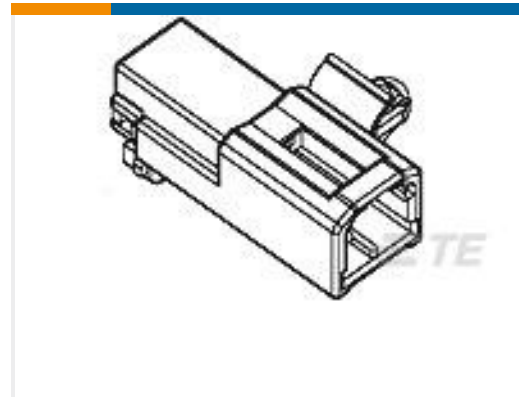

TE Part #178602-1
070 MULTILOC CAP HSG PANEL LOC



TE Part #1969591-4
HSG,REC,PANEL MOUNT,GWT, SINGLE ROW,EP2.5



TE Part #1-1452842-3
22 POS FEMALE HSG ASSY



TE Part #1-2035077-4
PLUG HSG, 4 POSN HYBRID 0.64/2



TE Part #2315584-2
1POS,JPT,REC HSG ASSY,UNSLD



TE Part #2371642-1
SDE F POWER 2.5 22-26 ASSY

Documents

Product Drawings

[GET MALE TERM, A, SN](#)

English

CAD Files

[Customer View Model](#)

[ENG_CVM_CVM_1438299-2_K.2d_dxf.zip](#)

English

[3D PDF](#)



3D

Customer View Model

[ENG_CVM_CVM_1438299-2_K.3d_igs.zip](#)

English

Customer View Model

[ENG_CVM_CVM_1438299-2_K.3d_stp.zip](#)

English

By downloading the CAD file I accept and agree to the [Terms and Conditions](#) of use.

Datasheets & Catalog Pages

[GET 0.64 Interconnection System](#)

English

Product Specifications

[Application Specification](#)

English